



PEX Plumbing
Design and
Application
Guide



Zurn PEX Tubing and Fittings



Certified

Notice: This manual contains recommended installation instructions for Zurn PEX hot and cold water systems. Failure to observe these installation instructions may result in substandard performance of the system. Zurn Industries, Inc. expressly disclaims any responsibility or liability for substandard performance resulting from failure to comply with installation instructions.

ZURN PEX PLUMBING

Design and Application Guide

STANDARDS, LISTINGS, APPROVALS, OR ACCEPTANCES

PEX Plumbing Systems are covered in the following codes, standards or approvals:

ASTM F876	American Society for Testing and Materials
ASTM F877	
ASTM F1807	
ANSI/NSF Standard 14	NSF International
ANSI/NSF Standard 61	NSF International
CAN/CSA B137.5	Canadian Standards Association
IPC	International Plumbing Code
IRC	International Residential Code
UPC	International Association of Plumbing and Mechanical Officials
State and Local	City, County, and State Residential Code Acceptance Contact your local plumbing official

The standards and code bodies above may not list all elements comprising the Zurn PEX System. Check your local code under “cross-linked polyethylene” or “PEX.”

MARKING

All Zurn PEX tube is marked with nominal size, wall thickness, pressure rating, NSF-PW, and the applicable ASTM standards. Zurn PEX tube is for water applications only. Do not use with LP or natural gas.

See Figure 1.

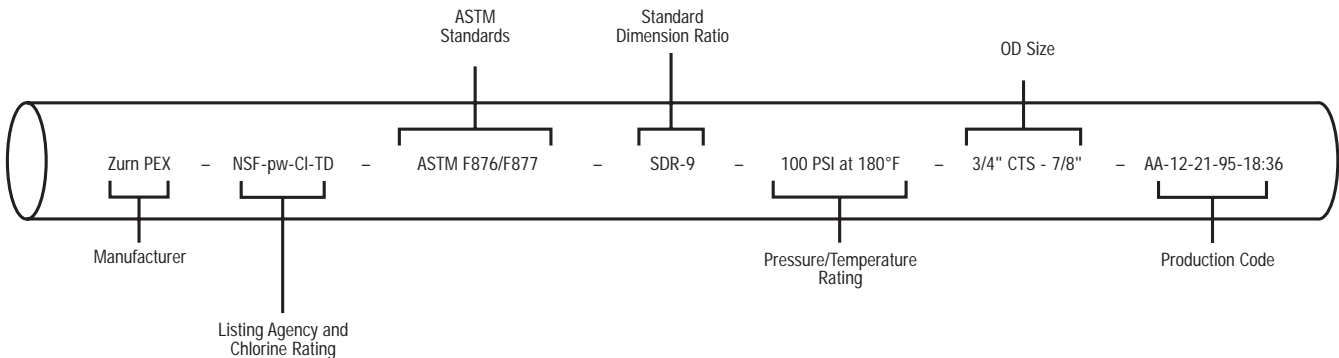


Figure 1

It is the sole responsibility of the installer to assure that this product meets local codes.

WHAT IS ZURN PEX?

Zurn PEX:

- is a flexible pipe for hot and cold water plumbing applications.
- is listed by NSF as safe for use with drinking water, meets or exceeds the requirements of ASTM F877.
- is installed using insert and crimp system of fittings, tools, and Go/No-Go gauges.
- can be used in residential and light commercial hot and cold water plumbing applications.
- can be used in hydronic radiant floor applications.
- may be bent in a radius as small as six (6) times the outside diameter of the tube.

IMPORTANT – Zurn PEX:

- should not be stored or installed where it will be exposed to direct or indirect ultraviolet light (i.e. sunlight).
- should not be exposed to direct flame.
- should not be used in excessive operating conditions inconsistent with pressure ratings that appear on tubing and applicable standards.
- should not be subjected to prolonged exposure to free chlorine concentrations greater than 4 ppm.
- should not be used in contaminated soils.
- should not be exposed to materials that affect the basic properties of cross-linked polyethylene, brass, or copper.



CAUTION:

Never use any chemicals, pipe thread compounds, putty, mineral or linseed oil products. They could damage your pipe and fittings.

NOTICE!

Zurn PEX fittings are identified by the letters “Q” and “PEX” stamped onto the body of the fitting. The PEX fittings also have two ribs on the insert portion of the fitting.

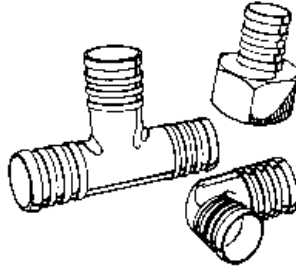
Zurn PEX crimp rings are identified by the letters “Q” and “PEX” stamped on the outside of the ring. Zurn PEX crimp rings are colored black for easy identification.

***WARNING:* It is the installer’s responsibility to avoid mixing PB and Zurn PEX components. Zurn Industries, Inc. does not guarantee or in any way warrant the installation of Zurn PEX systems due to the wide variance in installation practices.**

Mixing of PB and Zurn PEX components may cause plumbing system failure and result in severe water damage.

HOW THE ZURN PEX SYSTEM WORKS

This insert and crimp-ring system is designed to help a professional plumber make permanent, tightly sealed, leakproof connections for creation of a well-functioning Zurn PEX pipe hot and cold water distribution system or to repair any existing system. The tools and recommended techniques are explained in this guide.



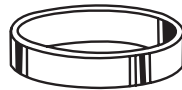
Fittings

Made of strong brass, the fitting is inserted into the end of the PEX pipe. A tightly sealed connection is formed by properly crimping a copper ring on the pipe. This process presses the fitting ribs into the pipe.



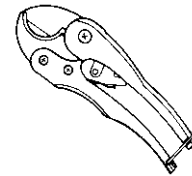
Crimp Tool

The tempered steel tool provides positive interlocking jaw action for precision crimping.



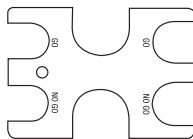
Crimp Ring

Annealed and ductile with a black finish, this precision-formed copper ring goes on the pipe and must be located over the ribs of the inserted fitting. When crimped, it permanently seals the pipe and fitting together.



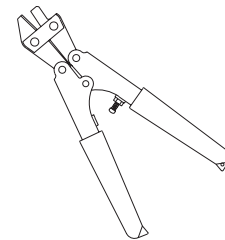
Cutting Tool

Designed for smooth, even cutting, the tool's jaw will fit firmly over the pipe to allow a square, burr-free cut.



Gauge

This flat steel "Go/No-Go" gauge lets you determine if a crimped connection was properly made.



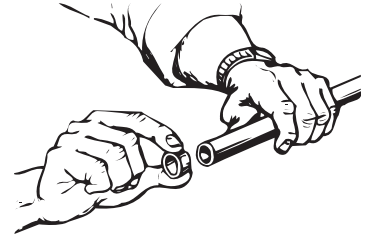
Crimp Ring Removal Tool

This compact tool assists in removing the crimp ring and PEX tubing without damaging the fitting. Using the ring removal tool allows a fitting to be safely reused.

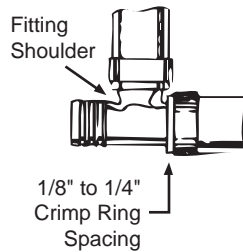
MAKING A CONNECTION



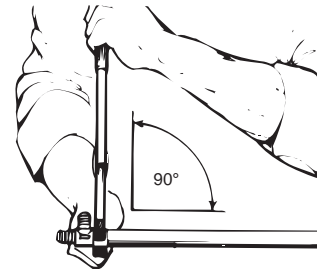
Measure and cut the pipe. Be sure you have a square burr-free cut. An uneven or jagged cut may cause an improper connection.



Next, slip a copper crimp ring onto the pipe. **Do not use hose clamps!**



Now insert the fitting into the pipe up to the fitting shoulder. Position the crimp ring 1/8" to 1/4" from the end of the tube. An improperly positioned ring may produce a weak connection.

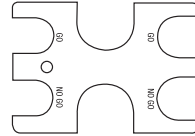


Position the tool so the crimp ring is completely covered by the tool jaws. Keep the tool at a 90° angle to the fitting and close it completely.

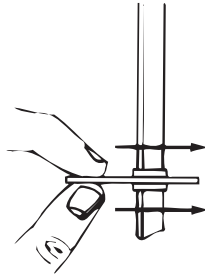
USING THE ZURN CHECKING GAUGE

After making crimp connections, use the appropriate opening of this flat “Go/No-Go” Gauge to check your finished crimp. The “Go” opening should go freely across a crimped ring anywhere on its diameter with the possible exception the upset area on the ring surface caused by the tool jaws closing. Do not force the gauge across the ring. The “No-Go” opening should not go across a crimped ring anywhere. **If the crimp fails either test, cut out the fitting and replace.**

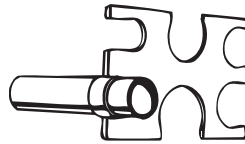
Go and No-Go Openings



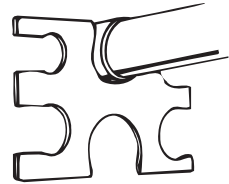
DO'S



Always place the gauge opening on the crimp ring at a 90° angle for an accurate check.

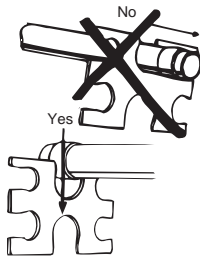


Be certain you use the gauge opening sized for the diameter of your pipe.



Replace non-conforming crimps.

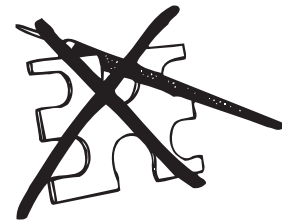
DON'Ts



Don't slide the gauge onto the connection by sliding it along the tube. Push it directly onto the crimped ring.



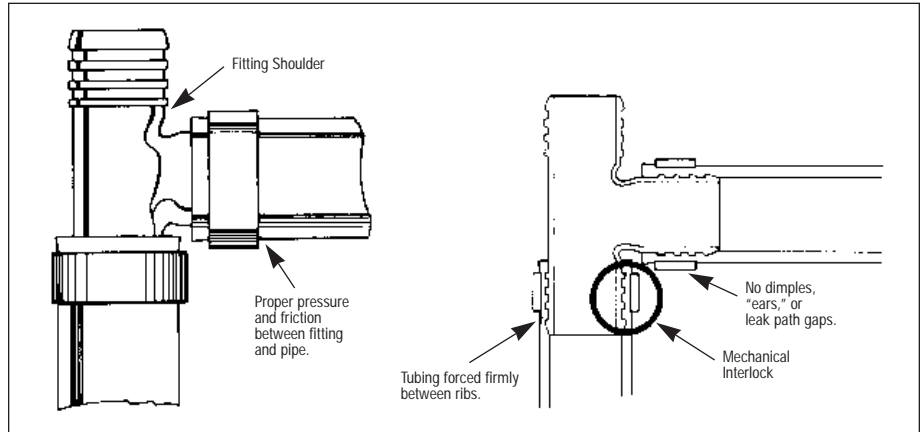
Don't try to save time by re-crimping a crimp that does not gauge properly. The fitting must be cut out and replaced.



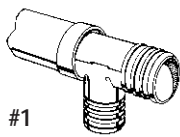
Don't modify the gauge opening areas for any reason. They have been carefully manufactured to .002 inch tolerance.

THE PERFECT CRIMP CONNECTION

The PEX tubing must be placed to the fitting shoulder. For fittings without a shoulder, the PEX tubing must be placed far enough to cover all the fitting barbs. The crimp ring is placed 1/8" to 1/4" from the shoulder or end of the PEX tubing.

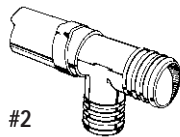


INCORRECT CONNECTIONS AND THE CONSEQUENCES



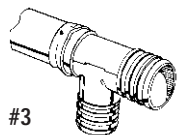
#1

- #1** Ring crimped over end of the tube.
Result: Does not cover enough ribs.



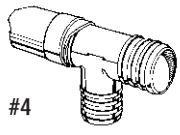
#2

- #2** Tool was not at 90° to the tube when crimped.
Result: Insufficient rib coverage; plastic dented.



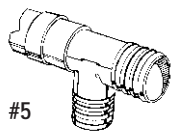
#3

- #3** Ring not completely covered by crimping tool.
Result: Ring distortion, non-uniform crimp.



#4

- #4** Tube not cut square.
Result: Insufficient rib coverage.



#5

- #5** Ring too far from pipe end.
Result: Insufficient rib coverage.

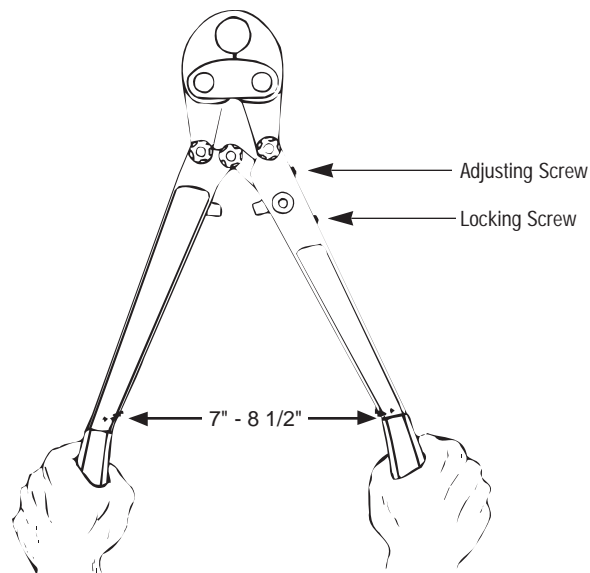
In every case, the final consequence is improper sealing and leak potential.

ADJUSTMENT (QCRT2T, QCRT3T, QCRT4T)

Zurn crimp tools are factory set to provide proper crimps. This should be checked before use by making a **test crimp** connection and checking it with the crimp gauge. As long as the finished crimp connection gauges properly, there is no need to adjust the tool. **We recommend checking each crimp connection with the Zurn Go/No-Go gauge.**

When the tool wears and the crimps no longer gauge properly, the tool needs adjusting. Follow these simple steps.

1. Loosen the bottom locking setscrew two turns using the hex wrench supplied with the tool.
2. Close tool until the jaws just touch and increased resistance is felt. This is the pre-load point.
3. Turn the top Adjusting Screw until the distance between the raised "+" marks on the handles is between 7 and 8-1/2 inches. Tighten the bottom locking setscrew.
4. Make a test crimp connection and check it with both the "Go" and "No-Go" openings of the gauge. If necessary, make additional adjustments. If the "No-Go" opening goes over the crimped ring, the tool is too tight. The distance between the "+" marks should be decreased. If the "Go" opening does not go over the crimped ring, the tool is too loose and the distance between the "+" marks should be increased.
5. Apply a light oil to the tool pivot points each time the tool is adjusted. **Failure to lubricate the tool will shorten its life.**

**WARNING:**

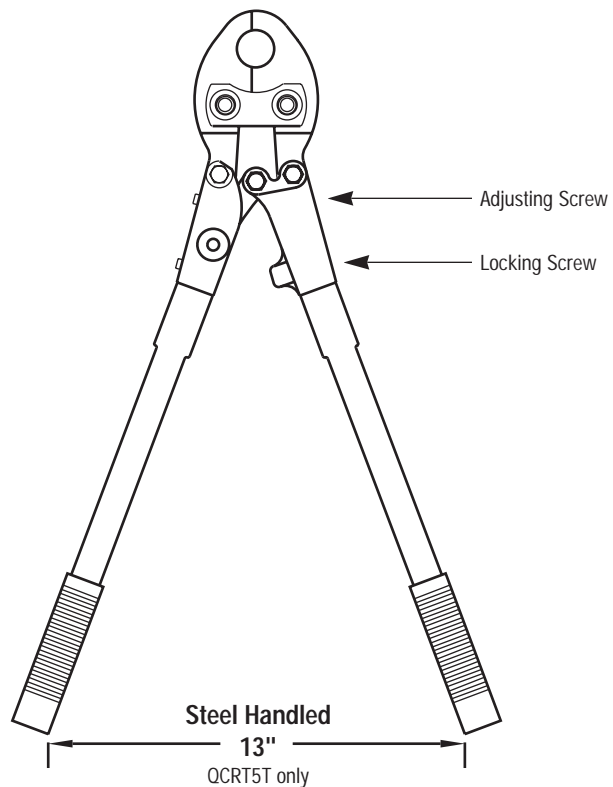
Increasing the pre-load distance beyond 9" will make the tool hard to use and shorten tool life because of excessive stress.

ADJUSTMENT (QCRT5T)

Zurn crimp tools are factory set to provide proper crimps. This should be checked before use by making a **test crimp** connection and checking it with the crimp gauge. As long as the finished crimp connection gauges properly, there is no need to adjust the tool.

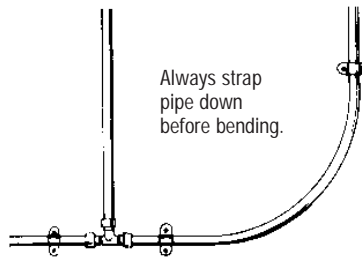
When the tool wears and the crimps no longer gauge properly, the tool needs adjusting. Follow these simple steps.

1. Loosen the bottom locking setscrew two turns using the hex wrench supplied with the tool.
2. Close tool until the jaws just touch and increased resistance is felt. This is the pre-load point.
3. Turn the top Adjusting Screw until the distance between the inside corners of the handles is 13 inches. Tighten the bottom locking setscrew.
4. Make a test crimp connection and check it with both the “Go” and “No-Go” openings of the gauge. If necessary, make additional adjustments. If the “No-Go” opening goes over the crimped ring, the tool is too tight. The distance between the inside corners of the handles should be decreased. If the “Go” opening does not go over the crimped ring, the tool is too loose and the distance between the inside corners of the handles should be increased.
5. Apply a light oil to the tool pivot points each time the tool is adjusted.
Failure to lubricate the tool will shorten its life.

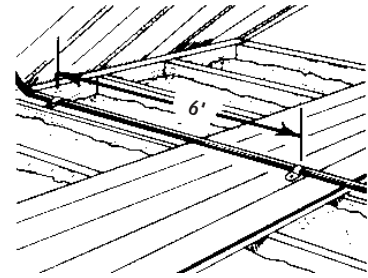
**WARNING:**

Increasing the pre-load distance beyond 13" will make the tool hard to use and shorten tool life because of excessive stress.

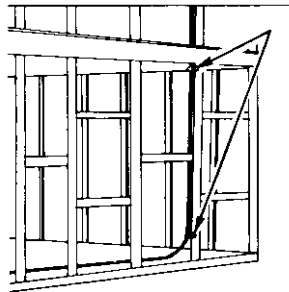
INSTALLING ZURN PEX PIPE



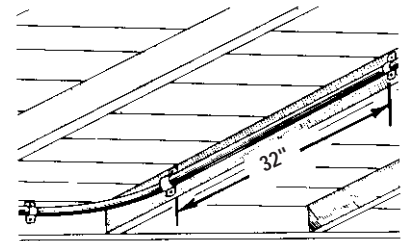
Zurn PEX straps and hangers hold pipe in position and prevent strain on fittings when the pipe is bent.



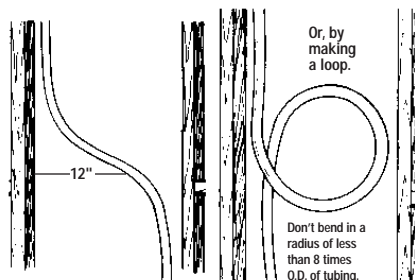
Straps can be as far as 6 feet apart if the pipe is continuously supported.



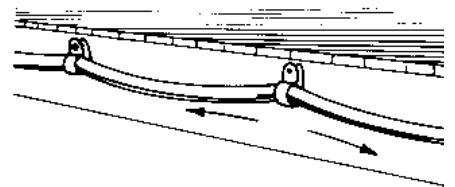
Vertical runs need support at every floor level.



Horizontal runs should be supported every 32 inches.



Since Zurn PEX expands or contracts one inch every 100 feet of pipe with every 10° of temperature change, you must allow for expansion and contraction in long runs with a 12-inch horizontal offset.



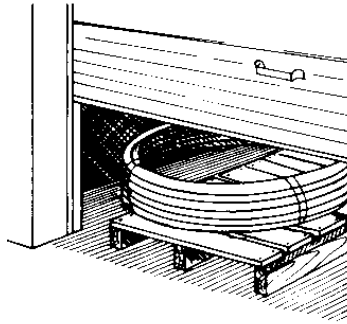
Always cut the pipe longer than necessary to allow some slack for any contraction in the pipe.

Strapping support should be firm but loose enough to allow the pipe to move back and forth as it expands and contracts.

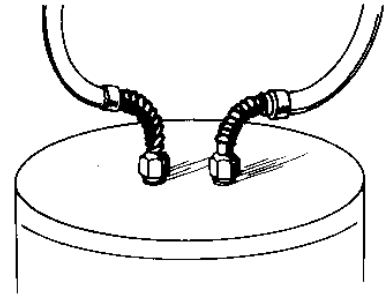
INSTALLING ZURN PEX PIPE, cont'd.

If installing under a slab, use only a **continuous length** through the trench. There must be **no connections under the slab**.

For details on buried pipe installations, see Page 19 of this Installation Guide.

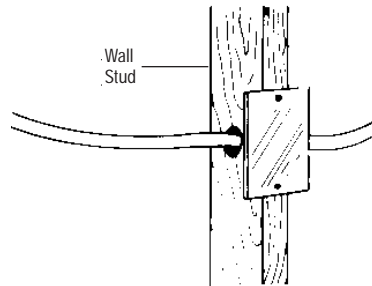


Long exposure to sunlight can weaken most plastics. Always store Zurn PEX tubing under cover – never in any location exposed to direct sunlight.

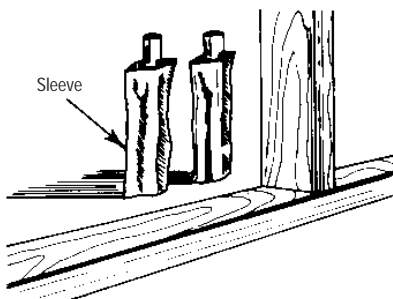


Zurn PEX may be connected directly to electric water heaters for residential plumbing applications. Zurn PEX has brass male and female threaded adapters and swivel adapters that can be used for this application.

Zurn PEX must be kept at least 6" away from the exhaust vent of a gas-fired water heater. This is easily accomplished by using flexible water heater connectors. When the inlet and outlet connections are well away from the exhaust vent, such as most heaters with side connections, Zurn PEX may be connected directly to the water heater.

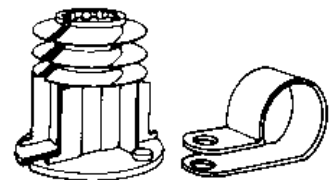


Protect pipe with a steel plate if it's within two inches of a stud, plate, or joist nailing surface.



Be sure to protect pipe with plastic sleeves where it enters and leaves the slab.

Use protective sleeves or bushings on Zurn PEX tube when penetrating metal studs. Sleeves and bushings are not required when penetrating ordinary wood or particle board if the holes are at least 1/8" larger than the tube size and tube movement is not restricted.



Best results are achieved by using clamps, pipe insulators, and strapping designed for plastic plumbing systems.

INSTALLING QICKPORT™ MANIFOLDS

The QickPort Manifold System is designed for efficient installation by the plumber. The purpose of this guide is to point out some of the features of the system and how to use them.

Other sections of this Zurn PEX illustrated Installation Guide should be referred to for general information on the use and installation of the Zurn PEX plumbing systems.

Sizing the Manifold

The manifold system allows individual hot or cold lines to be connected directly to each fixture inlet from the manifold. To size a cold water manifold, count the number of cold water locations in the house. Be sure to include outside hose bibbs. Also, include a line for the refrigerator ice maker, particularly if the refrigerator is not on the same wall as the kitchen sink.

To size the hot water manifold, count the number of hot water locations in the house.

QickPort manifolds are available in increments of five (5) outlet ports. Always purchase a manifold that has at least as many ports as the house has hot or cold locations. Attempting to supply two locations from a single manifold outlet may give unsatisfactory performance and may violate the local plumbing code. For a double vanity that has a continuous cabinet, some local codes will allow the second lavatory faucet to be connected to the first by using a tee fitting under the vanity. This will reduce the needed manifold ports by one on each manifold but care must be taken that it is acceptable to the local authorities.

All unused ports should be capped, even if the valve is closed.

Locating the Manifold

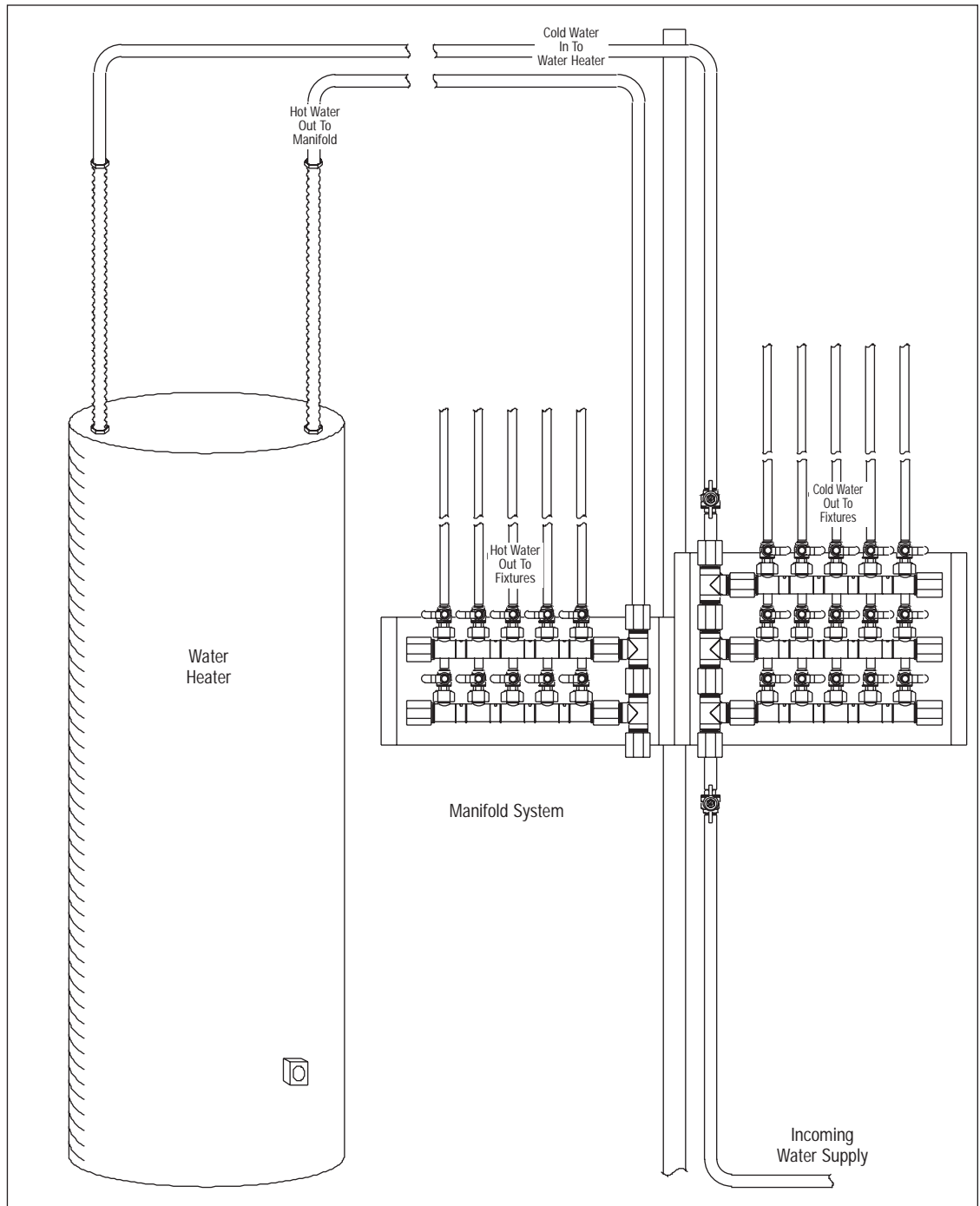
In general, manifolds should be installed in an accessible location very near the water heater.

They should be accessible because one-half of the joints in the plumbing system are at the manifolds and an accessible location improves the plumber's efficiency.

The hot water manifold should be as close as possible, but not closer than 18" from the water heater outlet. This will assure the minimum time for hot water to arrive at a fixture.

The cold water manifold may be located in any convenient location, but it is usually located near the hot water manifold or near the incoming water supply.

INSTALLING QICKPORT MANIFOLDS, cont'd.



INSTALLING QICKPORT MANIFOLDS, cont'd.***Horizontal Manifold Installation***

First, before installing the manifold, attach any shut-off valves that are going to be connected to the manifold.

Next, position the manifold in the desired location and nail or screw the mounting bracket to the studs. Make sure all valve handles have room for operation.

Vertical Manifold Installation

QickPort manifolds may be coupled end to end and installed vertically along a stud. Be sure to install any main shut-off valves before mounting the manifold to the stud.

Position the manifold in the desired location and fasten it to the studs.

Selecting the Tube Size

QickPort manifolds are designed for easy connection to 3/8" or 1/2" CTS Zurn PEX tube. When selecting the tube size, the following factors should be considered:

1. local code requirements;
2. water demand of the fixture;
3. distance from the manifold to the fixture;
4. elevation change from manifold to the fixture; and
5. water pressure available to the manifold.

Where possible, we recommend the use of 3/8" tubing. The smaller tubing means hot water arrives at the fixture faster and the smaller tubing can make smaller bends. With the reduced water usage of most sink and lavatory faucets and showers (typically 2.0 GPM), 3/8" tube is usually adequate unless the distance to be covered is more than 80 feet. The pressure loss information for 3/8" and 1/2" CTS tube is listed below.

QickPort manifolds have less than 1 psi pressure drop at total flow rates up to 20 GPM. Even if several branches are operating simultaneously, the pressure loss due to flow through the manifold is minimal.

Flow (GPM)	3/8" Pressure Drop psi/100 ft.	Velocity Ft./Sec.	1/2" Pressure Drop psi/100 ft.	Velocity Ft./Sec.
1	6.8	3.3	1.6	1.8
2	24.8	6.6	5.6	3.6
3	52.4	9.9	12.0	5.4
4			20.4	7.2
5			30.8	9.0
6			43.1	10.8

NOTE: A vertical manifold installation usually requires bending the Zurn PEX tube immediately off the manifold. Extra care must be taken to assure that the tube is not bent in a radius smaller than the minimum permitted for Zurn PEX which is six (6) times the outside diameter of the tube. Also, make sure that bending stress is not applied to the fitting that connects the tube to the manifold.

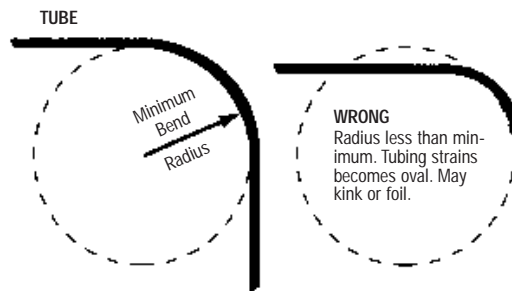
Do not install two vertical manifolds on opposite sides in the same stud cavity. There generally isn't room for correct bending of the Zurn PEX tube.

INSTALLING QICKPORT MANIFOLDS, cont'd.***Running the Zurn PEX Tube***

After the manifolds have been installed and the tube size selected, the next step is to install the Zurn PEX tube. When installing the tube, there are several points that must be considered:

1. Bending
2. Expansion and Contraction
3. Abrasion
4. Heat Sources
5. Friction Damage
6. Freeze Protection

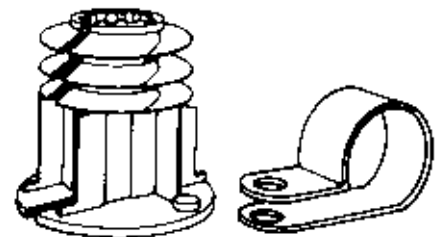
Zurn PEX's flexibility is key to making manifold systems practical. Like any material, it can be damaged if it is bent too tightly.



The minimum recommended bend radius for Zurn PEX is six (6) times the outside diameter of the tube when bending with the natural curvature of the coil. For 3/8" tube, this is a radius of 3" and for 1/2" tube, the minimum radius is 4". If the tube must be bent against the natural curvature of the coil, multiply the values by 3.

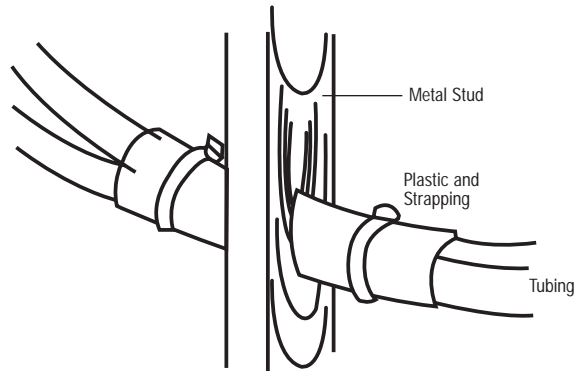
Zurn PEX expands and contracts more than most piping materials. Be sure to allow slack of approximately 1/8" per foot of length of tube to compensate. This will make sure the tube does not apply tension to the connections at the manifold or the fixture inlet.

Use protective sleeves or bushings on Zurn PEX tube when penetrating metal studs. Sleeves and bushings are not required when penetrating ordinary wood or particle board if the holes are at least 1/8" larger than the tube size and tube movement is not restricted.

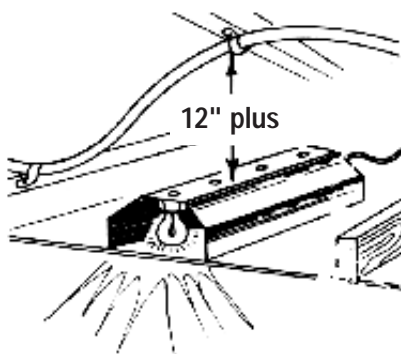
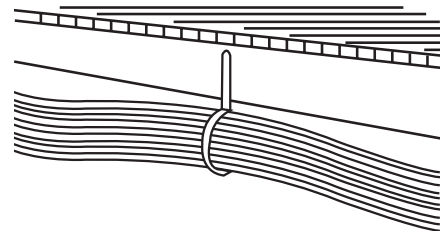


INSTALLING QICKPORT MANIFOLDS, cont'd.

Multiple tube bundles should be protected by wrapping a heavy gauge plastic sheet around the bundle at any area of potential abrasion. This plastic sheet may be fastened by using tape or nylon wire ties. Apply the tape to the sheet, not the Zurn PEX tube. This ensures that the tube can slide inside the protective plastic sheet. With nylon ties, be sure they are not so snug that they deform any of the tube.

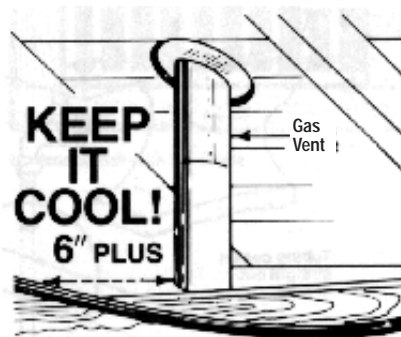


Zurn PEX tube should be supported or strapped every 32" when hung from floor joists or running across rafters. When supporting tube bundles, use a strap to support the entire bundle. Do not use a hook on one tube in a bundle to carry the weight of the entire bundle. Tubing run on a continuous support such as a floor in an attic, may be strapped at six-foot intervals.



The potential for heat transfer between different tubes in a bundle is very low. Zurn PEX's heat transfer rate is substantially less than copper. For this reason, we think mixing hot and cold lines in a bundle is not a problem. However, some plumbing codes do not permit mixing of hot and cold lines in the same bundle. Be sure to check the requirements of the local code.

When running the Zurn PEX tube, be sure to keep it away from potential sources of heat. Maintain a minimum of 12 inches between Zurn PEX and any recessed light fixture and a minimum of six inches between Zurn PEX and any gas appliance vent.



When installing runs of Zurn PEX, it is sometimes necessary to pull one tube past another. Care should be taken to make sure that the friction of the moving tube does not burn or wear a notch in the stationary tube. If this occurs, the notched section of tube must be cut out and replaced.

When it is necessary to drill holes for the tube in structural components of the building, be sure to comply with the requirements of the local building code.

INSTALLING QICKPORT MANIFOLDS, cont'd.***Stub Outs Through Walls***

Most Zurn PEX runs will terminate with some sort of stub-out fitting because the depth of a standard 2 x 4 wall is not sufficient to allow the Zurn PEX tube to be bent with a recommended bend unless a metal bend support is used. Zurn offers a metal bend support with a face plate, QMBS3WB, that is ideal for this purpose. Be sure the local code allows PEX stub-outs through walls. Zurn also offers several other fittings for stub-outs.

Copper stub-out elbows are available with either a 3/8" or 1/2" crimp connection to the Zurn PEX tube in the wall. The portion of the elbow that comes through the wall is 1/2" nominal copper pipe (5/8" O.D.).

Zurn drop ear elbows are available with either a 3/8" or 1/2" crimp connection to the Zurn PEX tube in the wall. These fittings have a 1/2" female pipe thread to allow the use of a threaded nipple to come through the wall.

Connecting Zurn PEX to the Manifold

The outlets of the valves on the QickPort manifold have 1/2" straight pipe threads. This allows several options for connecting the Zurn PEX tube to the manifold.

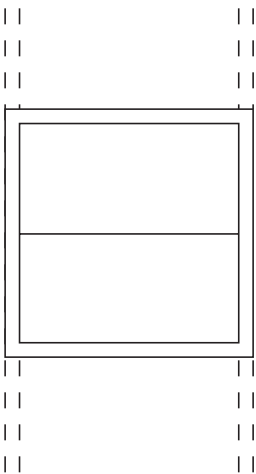
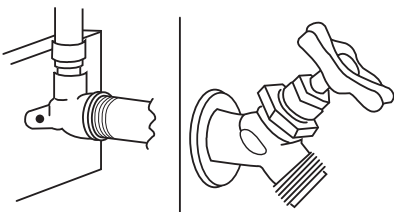
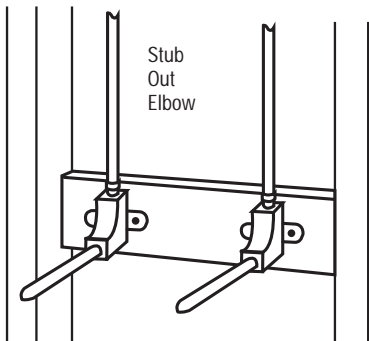
When using crimp fittings, the recommended connection is the QQSFC23X for 3/8" tube or the QQSFC33X for 1/2" tube. These brass swivel adapters allow you to make the crimp directly to the Zurn PEX tube and then connect the tube to the manifold. The same fittings with plastic nuts are also available.

If a compression connection at the manifold is desired, the recommended connection is a Zurn nut, ring, and cone set. For 3/8" tube, use the QFNCR2QP. For 1/2" tube, the QAFA33FQP is required.

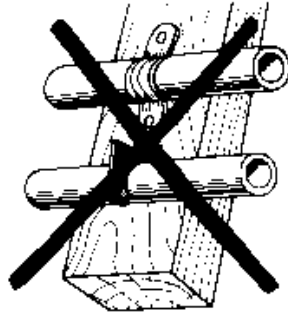
Finishing Touches

It is recommended that all tubes be labeled so they can be readily identified in the event the water must be shut off to a particular fixture. Zurn has preprinted label kits that allow this to be done in a professional manner. The labels are self-adhesive and are applied directly to the Zurn PEX tube.

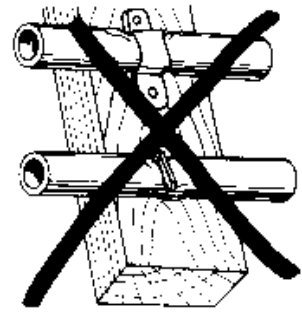
Doors are usually used to cover the manifolds. These may be made by a carpenter to match the other cabinets in the house or Zurn sells a plastic access panel that can be used. Zurn access panels come with a frame that can be fastened to the sheetrock with adhesive or screws for easy installation. The panels snap into place and are essentially flush with the sheetrock.

*Access Panel*

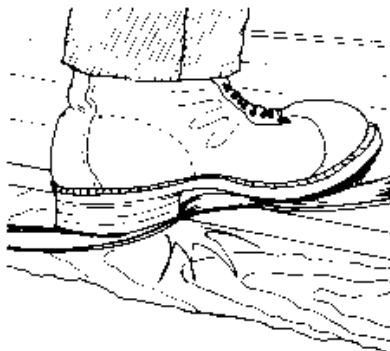
ZURN PEX PIPE DON'TS



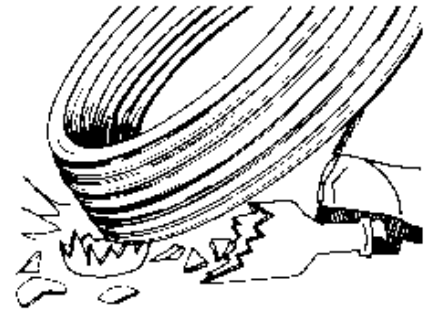
Don't use metal hangers with sharp or abrasive edges.



Or hangers that pinch the pipe!

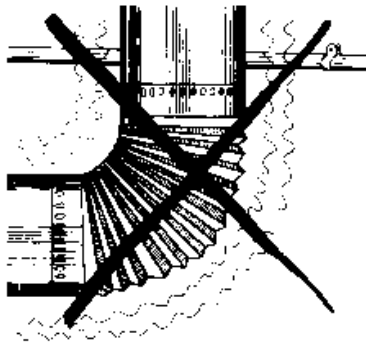


Don't crush it.

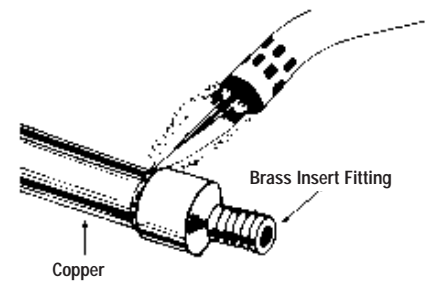


Don't scratch it.

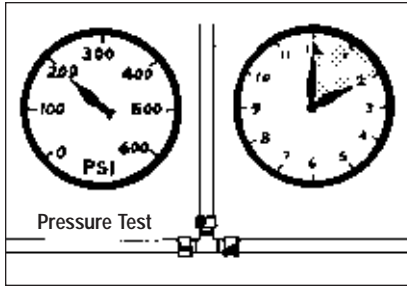
While an all Zurn PEX system is resistant to freeze damage, we recommend that all plumbing systems be protected from freezing in the usual manner. Zurn PEX cannot prevent damage to conventional materials if frozen and Zurn PEX itself may be damaged if conventional materials in the system are allowed to freeze.



Keep Zurn PEX pipe away from extreme heat.



NEVER apply flame directly to Zurn PEX. If you need to braze, solder, or weld, do it BEFORE you connect Zurn PEX to metal pipe.

**CAUTION**

Do not use leak detectors or other liquid solutions. Chemicals in certain soaps can cause disintegration of plastic tubing, so it is not a good idea to use a soap solution in any pressure test or for leak-checking in any way.

TESTING SYSTEM

- Test pressure shall be at least equal to normal system working pressure (main pressure), but not less than 40 psi and not greater than 225 psi.
- Test duration should not be less than 15 minutes.
- Test media may be water or compressed air.
- Test should meet local code requirements.

TROUBLE SHOOTING

Problem	Check
1. Crimp Ring will not go into "Go" gauge opening.	1. Crimp tool needs adjustment. Increase handle space.
2. Crimp Ring goes into "No-Go" gauge opening.	2. Crimp tool needs adjustment. Decrease handle space.
3. Crimp tool needs frequent adjustment.	3. Check for wear at pivot points. If holes or bolts are worn, tool must be replaced. Pivot points should be oiled every time tool is adjusted.
4. Tube is kinked.	4. Tubing was bent too tightly. Cut out kinked section and increase bend radius.
5. Tubing has chalky exterior surface or cracks when bent.	5. Tubing has been stored in sunlight and is damaged. DO NOT USE.
6. Crimp rings have a "silver" or "copper" color.	6. Proper crimp rings for Zurn PEX insert fittings are blackened copper. Zurn PEX crimp rings have "Q" and "PEX" stamped on them. Use only Zurn PEX crimp rings.
7. Crimped ring is distorted.	7. Tool was not at 90° to tube when crimp was made. Cut out and replace fitting.

WATER SERVICE INSTALLATION

Substandard tube performance may result if these instructions are not followed.

Before You Start

Applications

Check to be sure that the tube you are using has the correct pressure rating for local requirements. Usual practice is to have the pressure rating of the tube 1-1/2 times higher than the maximum water system pressure to allow for pressure surges in the system due to water hammer, pumps turning on and off, etc. Zurn PEX tube has a pressure rating of 160 psi @ 73°F.

Inspection

Inspect all pipe before installing. Cut out any damaged areas (cuts, punctures, excessive abrasion) and areas where the pipe has been kinked or pinched.

Contaminated Soil

Zurn PEX tube is not recommended for underground use in areas of known soil contamination or where there is a high risk of chemical spills. Zurn PEX should not be installed in contact with soil or under slabs in areas known to be contaminated by, for example, organic solvents or petroleum distillates. It should not come in contact with soil near hazardous waste disposal sites or underground chemical or petroleum storage tanks. If you are uncertain about the possibility of soil contamination at your installation site, contact your local authorities.

Fittings

Several types of fittings are available for use with Zurn PEX. However, Zurn cannot be responsible for the performance or design of other manufacturer's products.

PVC Fittings

Molded PVC fittings for use with Zurn PEX are commercially available for water service tube. These fittings have a molded internal stiffener, an O-ring seal, a steel gripper, and a nut to hold it all together. They are available as couplings, male and female adapters, and spigot adapters.

See Figure 2.

Note: Zurn Qicktite fittings are not recommended for use and should not be used in water service applications.

Brass Fittings

Compression fittings normally used with copper tubing can be used to connect Zurn PEX to corporation and curb stops. When compression fittings are used, a type with a split clamp is recommended to ensure that the internal stiffener will not move as a result of expansion and contraction of the pipe. Follow the fitting manufacturer's recommendations for proper installation and use of their fitting.

Teflon tape is the **only** recommended thread sealant for fittings used with Zurn PEX. **Conventional pipe thread compounds, putty, mineral or linseed oil-based products, and unknown mixtures should never be used as these materials may cause damage to the pipe and fittings.**

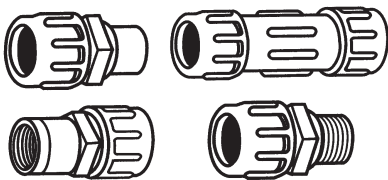


Figure 2

WATER SERVICE INSTALLATION, cont'd.***Cutting the Pipe***

Zurn PEX should be cut with a tubing cutter that is equipped with a thin cutting wheel designed specifically for plastics. Gould Imperial, Reed Manufacturing Co., Ridge Tool Co., and other firms furnish this type of cutter. To cut the tube, make a single revolution in one direction for tracking followed by one or two revolutions in the opposite direction. Cuts should always be square and clean. If other methods are used to cut the pipe (such as a saw), sandpaper should be used to remove any excess material, flashing or burrs, and to smooth the end of the pipe.

See Figure 3.

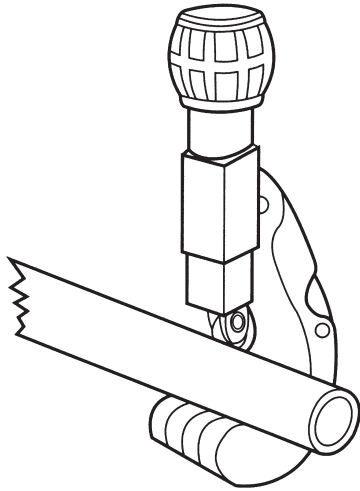


Figure 3

Installation

Procedures for installing Zurn PEX, incorporating information from ASTM, AWWA, PPI, and other organizations, are described in the following sections. Information obtained from several water departments also has been included. These recommendations must be followed in order for Zurn PEX to perform properly.

Trench Bottom Preparation

To achieve a satisfactory installation of Zurn PEX, it is essential that the supporting soil provide a stable and permanent support for the pipe. Where good soil conditions exist and the trench bottom can be cut accurately, the pipe can be installed directly on the prepared bottom. The bottom must be flat with no hollows, no lumps, no rocks, and no other sharp objects. In case of **loose, rocky soil**, the trench should be excavated at least 6" deeper than the desired pipe depth and filled with suitable soils such as coarse sand or peagravel. If the soil consists of **solid rock**, graded, tamped granular class I material should be placed over the rock formation. The material should not be so fine that it would wash out and cause subsequent settling of the pipe. In **unstable soils** such as black gumbo, the trench should be overexcavated by at least 4" and the trench refilled with sand or peagravel. Regardless of soil condition, the backfill should be free of rocks, glass, or other sharp objects. **See Figure 4.**

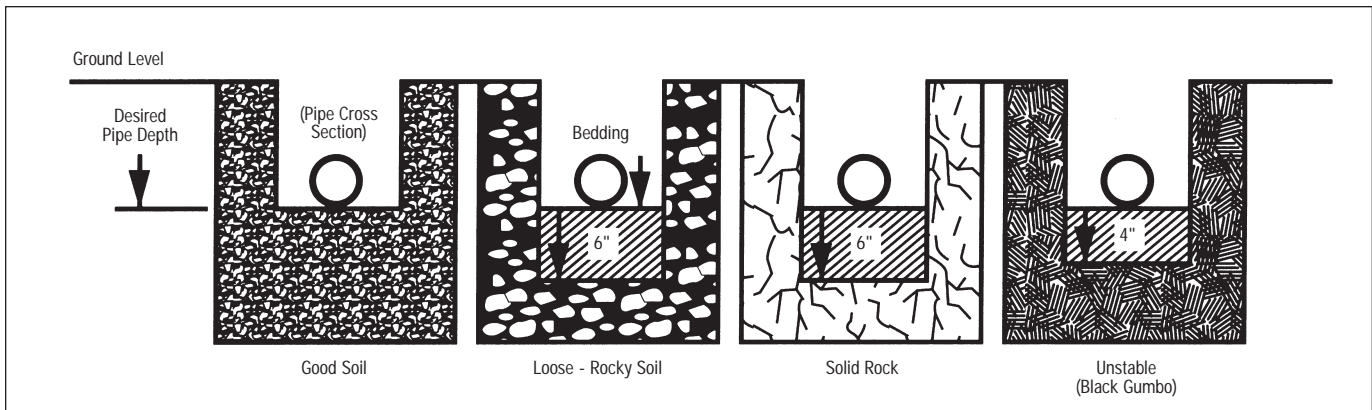
Trench Cross Sections

Figure 4

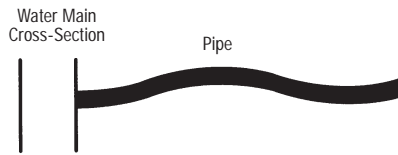


Figure 5

WATER SERVICE INSTALLATION, cont'd.

Thermal Expansion and Contraction

The linear expansion rate for Zurn PEX is approximately one inch per 100 feet of tubing per 10°F change in temperature. When installing pipe, add 1/8" per running foot to accommodate thermal expansion or about 13 inches per 100-foot run. Snake the pipe uniformly along the length of the trench. **See Figure 5.**

Connecting to Curb Stop

A general rule to remember when installing Zurn PEX is: the less the effect of surrounding soil movements on the tubing, the better. The diagram below shows a recommended installation for a curb stop. **See Figure 6.**

Other approaches requiring double (or "S") bends are not recommended as they are more prone to undesirable settlement which may subject the pipe to excessive stress.

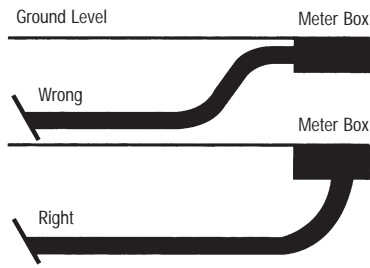


Figure 6

Penetration of Basement or Foundation Walls

When Zurn PEX is run through a basement or foundation wall, it must be protected by a rigid sleeve that spans the distance from within the wall out to the undisturbed soil in the pipe trench. The purpose of this protective sleeve is to prevent shearing of the PEX tubing at the wall in the event there is settlement in the backfill around the wall. At the point where the sleeve terminates inside the foundation or wall, the space between the Zurn PEX and the sleeve should be sealed to prevent leakage into the building.

Note: Petroleum based caulks or sealants should not come in direct contact with Zurn PEX. **See Figure 7.**

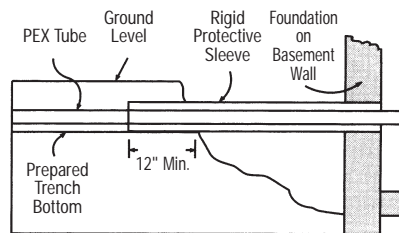


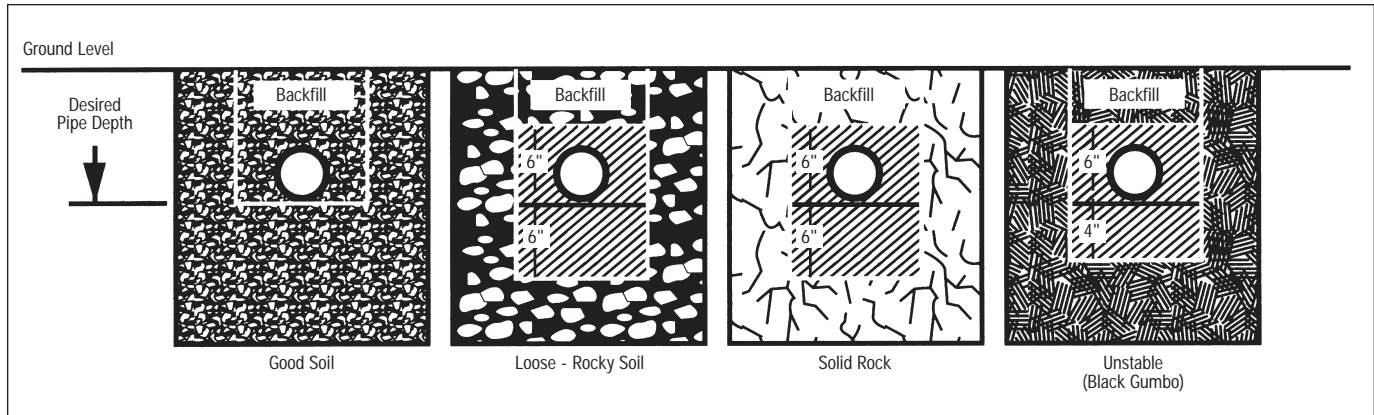
Figure 7

Pressure Testing

Water service lines should be pressure tested **before** the trench is back-filled with soil. Before applying pressure to the pipe, make sure that all air is bled from the system. A large pocket of air in the pipe can cause a severe water hammer that could damage the pipe. After a service line has been installed and filled with water, it should be tested using a pressure approximately 50 percent greater than the expected operating pressure. Run the test for at least one hour.

WATER SERVICE INSTALLATION, cont'd.***Backfilling and Compaction***

Before backfilling, be sure the trench is free of all foreign objects such as scraps of wood, metal, or glass which might puncture the pipe when buried in the trench. If the original soil removed from the trench is rocky or otherwise unsuitable, the pipe should be covered with a compacted 6" layer of coarse sand or peagravel before continuing the backfill with the original soil. **See Figure 8.**

Trench Cross Sections**Figure 8**

Clays require more compaction than granular material, with the amount of compaction needed being dependent on the clay's moisture content. In cases when an unfavorable combination of black gumbo type clay and large variations in the water table exist, the natural bedding material should be replaced by materials that are less prone to expansion and contraction such as sand and peagravel.

Pipe Failures Caused By Improper Installation

An unnecessarily short service life for Zurn PEX may result if the precautions outlined previously are not followed.

Insufficient slack and excessive longitudinal stresses as a result of temperature variations may cause pull-out failures. Shear-off failures (circumferential cracks in the pipe wall within one inch of the fittings) can be caused by improper positioning of the metal stiffener during installation (see fitting manufacturer's recommendations) or by excessive bending stresses. It is also possible that this type of failure will be caused by temperature variations and resulting stresses, causing the metal stiffener to travel. As soon as the stiffener is no longer flush with the end of the compression fitting, it may start to cut off the pipe from the inside, resulting in shear-off failure. Although a compression fitting with a split clamp will provide greater assurance of a well-secured fitting than one without a split clamp, it is more important to address the cause of problems by minimizing stresses in the pipe through proper installation.

WATER SERVICE INSTALLATION, cont'd.

Preparing the trench bottoms, gauging the tapping angles, connecting to curb stops, backfilling the trenches, and compacting the soil are all important factors when using Zurn PEX for buried water service. Successful installation of the pipe, however, depends on only two major points:

- 1.** Preventing sharp objects from contacting the pipe.
- 2.** Preventing undesirable stress on the pipe.

Electrical Grounding

Metal pipes are often used (against the pipe supplier's recommendations) as the grounding electrode for electrical equipment. Zurn water service tube, being a poor conductor, cannot be used for this purpose. The National Electric Code should be consulted for recommended grounding methods when plastic pipe is used.

Water Line Disinfection

Some code jurisdictions require disinfection of potable water service lines. The most commonly used standard is AWWA C-601-81, which specifies a chlorine concentration of at least 50 milligrams/liter (50 ppm) for 3 hours. The Southern Building Code Congress recommends 50 ppm for 6 hours. Zurn PEX will not be adversely affected by this exposure but care should be exercised to avoid use of high chlorine concentrations (above 300 ppm) for more than 12 hours, as this could damage the pipe. The system should be thoroughly flushed at the end of any disinfection period.

PROFESSIONAL INSTALLATION LIMITED WARRANTY

Subject to the terms and conditions of this Limited Warranty, Zurn PEX Plumbing and Radiant Heating Systems warrants only to the owner of the real property when installed by licensed professional contractors or authorized distributors who purchase and properly install in a potable plumbing system and/or radiant heating system its:

- (I) Zurn PEX Non-Barrier and Barrier cross-linked polyethylene tubing (PEX) and Qick/Sert® insert fittings, when installed as a system with our Zurn PEX Non-Barrier and Barrier cross-linked polyethylene tubing (PEX), for a period of twenty-five (25) years, and
- (II) QickPort Plumbing manifolds, under normal conditions of use, for a period of ten (10) years, and
- (III) Qick/Sert® insert fitting when not installed with Zurn PEX Non-Barrier and Barrier cross-linked polyethylene tubing (PEX) and installed with PEX tubing that meets the ASTM F876 requirements for a period of five (5) years, and
- (IV) the associated hardware and accessories, including manifolds, distribution headers, valves, electrical controls, tools, and miscellaneous fittings for a period of two (2) years from the date of installation.

In order for this Limited Warranty to apply, the above referenced products must be installed by a licensed professional contractor in accordance with Zurn installation instructions as outlined in the Zurn Installation Guide, meeting all applicable code requirements and good plumbing practices. **FAILURE TO INSTALL ZURN PEX PRODUCTS ACCORDING TO MANUFACTURER'S INSTRUCTIONS WILL VOID ALL APPLICABLE WARRANTIES AND MAY RESULT IN SEVERE WATER DAMAGE.** See our free Zurn PEX Installation Guide for instructions. For your copy, call toll-free 1-800-872-7277. Under this warranty, you only have a right to reimbursement if the failure or leak is a direct result of a manufacturing defect in the products covered by this warranty and occurred during the warranty period. This warranty does not apply and you do not have a right of reimbursement if the failure or resulting damage is caused by:

- (I) freezing during or after the installation or inadequate freeze protection;
- (II) damage due to tear, breaks, or other external damages before, during, or after installation;
- (III) components not manufactured or sold by Zurn;
- (IV) exposure to temperatures and pressures beyond the specified range for Zurn products as specified on the product or in the Zurn PEX Installation Manual or Zurn Design Manual;
- (V) exposure to harmful, unauthorized or unanticipated chemicals or substances or corrosive water conditions;
- (VI) exposure to ultraviolet light;
- (VII) damage or wear from abnormal operating conditions, accident, abuse, misuse, or unauthorized alterations or repair.

PROFESSIONAL INSTALLATION LIMITED WARRANTY, cont'd.

THIS WARRANTY IS IN LIEU OF ALL OTHER WARRANTIES OR OBLIGATIONS, EXPRESS OR IMPLIED, INCLUDING ANY IMPLIED WARRANTY OF MERCHANTABILITY OR FITNESS FOR A PARTICULAR PURPOSE. ZURN DOES NOT GUARANTEE OR IN ANY WAY WARRANT THE INSTALLATION OF ZURN PEX PRODUCTS DUE TO THE WIDE VARIANCE IN INSTALLATION PRACTICES AND OTHER CONDITIONS BEYOND OUR CONTROL.

If you believe that a product fails to meet the above Limited Warranty, you should notify us in writing within 30 days following the failure and prior to expiration of the applicable warranty period set forth above, at the following address:

Zurn Industries, Inc.
Zurn PEX Plumbing and Radiant Heating Systems
1801 Pittsburgh Avenue
Erie, PA, 16502
Attention: Claims Department

Notification should include a description of the product, the failed part, model number (if available), date of purchase and/or date of installation, and how the product fails to meet the above warranty. Upon receipt of a written claim under this Limited Warranty and evidence/identification of the date of manufacture of product, and after inspection by an authorized Zurn representative and determination of a manufacturing defect, Zurn will reimburse the property owner for reasonable repair or replacement charges, to include drywall and painting, as well as damages to real property and the premises within which the product is installed, resulting from the failure or leak. At our option, and in our sole discretion, we will either repair or replace the product with a Zurn product of the same or similar type, size, and like quantity. Except as specified above, we will not pay any costs (labor or otherwise) associated with removing previously installed product(s), installing replacement product(s), or transportation or return of a product. If, as determined by Zurn, repair or replacement of the product is not commercially practicable, or cannot be completed in a timely manner, we may refund the ultimate purchase price paid for the product upon verification by providing a copy of your purchase order, invoice, receipt, or bill of sale.

ZURN WILL NOT BE LIABLE FOR ANY OTHER LOSS OR EXPENSE(S) NOT SPECIFICALLY DESCRIBED ABOVE, AND DISCLAIMS ANY LIABILITY FOR CONSEQUENTIAL OR INCIDENTAL DAMAGES.

For more information, call Zurn toll free at 1-800-872-7277.



ZURN PLUMBING PRODUCTS GROUP

PEX PLUMBING SYSTEMS
1801 PITTSBURGH AVENUE
ERIE, PA 16502
PHONE: 1-800-872-7277
FAX: 1-800-209-2148
WEBSITE: www.zurn.com

In Canada:

ZURN INDUSTRIES LIMITED

3544 NASHUA DRIVE
MISSISSAUGA, ONTARIO CANADA L4V 1L2
PHONE: 905/405-8272
FAX: 905/405-1292

Form No. ZPM03103