



U.S. Department  
of Transportation

Federal Aviation  
Administration

# Advisory Circular

---

Subject: Heliport Design

Date: 4/24/2012

AC No: 150/5390-2C

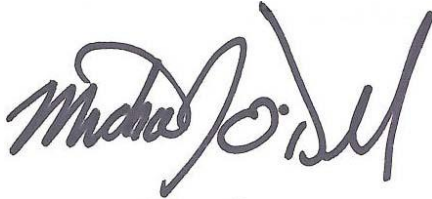
Initiated by: AAS-100

Change:

---

- 1. Purpose.** This advisory circular (AC) provides standards for the design of heliports serving helicopters with single rotors. Apply basic concepts to facilities serving helicopters with tandem (front and rear) or dual (side by side) rotors, however many standards will not apply.
- 2. Cancellation.** This AC cancels AC 150/5390-2B, Heliport Design, dated September 30, 2004.
- 3. Application.** The Federal Aviation Administration (FAA) recommends the guidelines and specifications in this AC for materials and methods used in the construction of heliports. In general, use of this AC is not mandatory. However, use of this AC is mandatory for all projects funded with federal grant monies through the Airport Improvement Program (AIP) and with revenue from the Passenger Facility Charge (PFC). See Grant Assurance No. 34, Policies, Standards, and Specifications, and PFC Assurance No. 9, Standards and Specifications. For information about grant assurances, see [http://www.faa.gov/airports/aip/grant\\_assurances/](http://www.faa.gov/airports/aip/grant_assurances/). The use of terms implying strict compliance applies only to those projects. Other federal agencies, states, or other authorities having jurisdiction over the construction of other heliports decide the extent to which these standards apply.
- 4. Principal changes.**
  - a. Changed the term for the helicopter overall length (OL) to ‘D’ or ‘D-value.’
  - b. Added definitions for design loads for static and dynamic load-bearing areas (LBA).
  - c. Added guidance for pavement or structure larger than the touchdown and liftoff area (TLOF), but less than the size of the final approach and take off (FATO).
  - d. Added guidance for turbulence effects.
  - e. Added guidance to provide adequate clearance between parking areas and taxi routes and within parking areas.
  - f. Added guidance for minimum dimensions of curved approach/departure airspace.
  - g. Added guidance for Touchdown/Positioning Circle (TDPC) Marking.
  - h. Added guidance for Flight Path Alignment Guidance markings and lights.
  - i. Added an appendix providing guidance for Emergency Helicopter Landing Facility Requirements (EHLF).
  - j. Added FATO to FATO separation distance for simultaneous operations.
  - k. Revised standards for size of “H” for general aviation heliports.
  - l. Added increased TLOF size when the FATO of a hospital heliport is not load bearing.

- n.** Combined chapter 6, Non-Precision Instrument Operations and Chapter 7, Precision Approach Operations into chapter 6, Instrument Operations. Reference FAA Order 8620 series.
  - o.** To improve the legibility of the AC, changed the format to a single column and nested the tables in the text.
  - p.** Deleted requirements for load bearing capacity of a FATO at general aviation and hospital heliports when the TLOF is marked.
  - q.** Changed color of landing direction lights from yellow to green.
  - r.** Added references to Engineering Brief 87, Heliport Lights for Visual Meteorological Conditions (VMC).
- 5. Use of metrics.** This AC includes both English and metric dimensions. The metric conversions may not be exact equivalents, and the English dimensions govern.
- 6. Copies of this AC.** This and other advisory circulars published by the Office of Airport Safety and Standards are available on the FAA Office of Airports web page at [www.faa.gov/airports](http://www.faa.gov/airports).



MICHAEL J. O'DONNELL

Director of Airport Safety and Standards

## TABLE OF CONTENTS

Paragraph	Page
<b>Chapter 1. Introduction .....</b>	<b>1</b>
101. Background .....	1
102. General .....	1
103. Facilities .....	1
104. Planning .....	1
105. Existing heliports .....	1
106. Location .....	1
107. AC organization .....	2
108. Explanation of terms .....	2
109. Selection of approach/departure paths .....	6
110. Notification requirements .....	6
111. Hazards to air navigation .....	9
112. Federal assistance .....	10
113. Environmental impact analyses .....	10
114. Access to heliports by individuals with disabilities .....	11
115. State role .....	11
116. Local role .....	11
117. Related referenced material .....	11
 <b>Chapter 2. General Aviation Heliports.....</b>	 <b>13</b>
201. General .....	13
202. Applicability .....	13
203. Prior permission required (PPR) facilities .....	14
204. Access by individuals with disabilities .....	14
205. Heliport site selection .....	14
206. Basic layout .....	14
207. Touchdown and liftoff area (TLOF) .....	15
208. Final approach and takeoff area (FATO) .....	20
209. Safety area .....	22
210. VFR approach/departure paths .....	22
211. Heliport protection zone (HPZ) .....	29
212. Wind cone .....	29
213. Taxiways and taxi routes .....	29
214. Helicopter parking .....	35
215. Heliport markers and markings .....	44
216. Heliport lighting .....	53
217. Marking and lighting of difficult-to-see objects .....	58
218. Safety considerations .....	61
219. Visual glideslope indicators (VGSI) .....	64
220. Terminal facilities .....	64
221. Zoning and compatible land use .....	64

<b>Chapter 3. Transport Heliports .....</b>	<b>65</b>
301. General .....	65
302. Applicability.....	65
303. Access by individuals with disabilities.....	65
304. Heliport site selection.....	65
305. Basic layout.....	67
306. Touchdown and liftoff area (TLOF).....	67
307. Final approach and takeoff area (FATO).....	71
308. Safety area.....	72
309. VFR approach/departure paths.....	73
310. Heliport protection zone (HPZ).....	76
311. Wind cone.....	76
312. Taxiways and taxi routes.....	77
313. Helicopter parking.....	77
314. Heliport markers and markings.....	88
315. Heliport lighting.....	93
316. Marking and lighting of difficult-to-see objects.....	100
317. Safety considerations.....	103
318. Visual glideslope indicators (VGSI).....	105
319. Terminal facilities.....	107
320. Zoning and compatible land use.....	107
<b>Chapter 4. Hospital Heliports.....</b>	<b>109</b>
401. General.....	109
402. Applicability.....	109
403. Access by individuals with disabilities.....	109
404. Heliport site selection.....	109
405. Basic layout.....	112
406. Touchdown and liftoff area (TLOF).....	112
407. Final approach and takeoff area (FATO).....	114
408. Safety area.....	116
409. VFR approach/departure paths.....	118
410. Heliport protection zone (HPZ).....	123
411. Wind cone.....	123
412. Taxiways and taxi routes.....	126
413. Helicopter parking.....	130
414. Heliport markers and markings.....	138
415. Heliport lighting.....	147
416. Marking and lighting of difficult-to-see objects.....	154
417. Safety considerations.....	157
418. Visual glideslope indicators (VGSI).....	159
419. Zoning and compatible land use.....	159
<b>Chapter 5. Helicopter Facilities on Airports.....</b>	<b>161</b>
501. General.....	161

502.	Applicability.....	161
503.	Touchdown and liftoff area (TLOF).....	161
504.	Final approach and takeoff area (FATO).....	161
505.	Safety area.....	161
506.	VFR approach/departure paths.....	161
507.	Heliport protection zone (HPZ).....	162
508.	Taxiways and taxi routes.....	162
509.	Helicopter parking.....	162
510.	Security.....	162
<b>Chapter 6. Instrument Operations.....</b>		<b>165</b>
601.	General.....	165
602.	Planning.....	165
603.	Airspace.....	165
604.	Final approach reference area (FARA).....	165
605.	Improved lighting system.....	165
606.	Obstacle evaluation surfaces.....	166
<b>Chapter 7. Heliport Gradients and Pavement Design.....</b>		<b>169</b>
701.	General.....	169
702.	TLOF gradients.....	169
703.	FATO gradients.....	169
704.	Safety area gradients.....	169
705.	Parking area gradients.....	169
706.	Taxiway and taxi route gradients.....	169
707.	Design loads.....	171
708.	Pavement design and soil stabilization.....	171
<b>Appendix A. Emergency Helicopter Landing Facilities (EHLF).....</b>		<b>175</b>
<b>Appendix B. Helicopter Data.....</b>		<b>179</b>
<b>Appendix C. Dimensions for Marking Size and Weight Limitations.....</b>		<b>185</b>
<b>Appendix D. Associated Publications and Resources.....</b>		<b>187</b>

## LIST OF FIGURES

Figure 1–1.	Form 7480-1, Notice of Landing Area Proposal.....	7
Figure 1–2.	Example of a Heliport Layout Plan.....	8
Figure 1–3.	Example of a Heliport Location Map.....	10
Figure 1–4.	Offsite Development Requiring Notice to the FAA.....	12
Figure 2–1.	Essential Features of a Heliport: General Aviation.....	13

Figure 2–2. TLOF/FATO Safety Area Relationships and Minimum Dimensions: General Aviation.....	16
Figure 2–3. Elongated FATO with Two Takeoff Positions: General Aviation .....	17
Figure 2–4. Elevated Heliport: General Aviation .....	19
Figure 2–5. Additional FATO Length for Heliports at Higher Elevations: General Aviation .....	21
Figure 2–6. Non-load-bearing FATO and Safety Area: General Aviation .....	23
Figure 2–7. VFR Heliport Approach/Departure and Transitional Surfaces: General Aviation .....	25
Figure 2–8. Curved Approach/Departure: General Aviation .....	26
Figure 2–9. VFR PPR Heliport Lateral Extension of the 8:1 Approach / Departure Surface: General Aviation.....	27
Figure 2–10. VFR PPR Heliport Lateral Extension of the Curved 8:1 Approach / Departure Surface: General Aviation .....	28
Figure 2–11. Flight Path Alignment Marking and Lights: General Aviation .....	30
Figure 2–12. Heliport Protection Zone: General Aviation.....	31
Figure 2–13. Taxiway/Taxi Route Relationship – Paved Taxiway: General Aviation.....	32
Figure 2–14. Taxiway/Taxi Route Relationship – Unpaved Taxiway with Raised Edge Markers: General Aviation .....	33
Figure 2–15. Taxiway/Taxi Route Relationship – Unpaved Taxiway with Flush Edge Markers: General Aviation.....	34
Figure 2–16. Parking Area Design – “Taxi-through” Parking Positions: General Aviation .....	37
Figure 2–17. Parking Area Design – “Turn-around” Parking Positions: General Aviation .....	38
Figure 2–18. Parking Area Design – “Back-out” Parking Positions: General Aviation.....	39
Figure 2–19. “Turn-around” Parking Position Marking: General Aviation.....	40
Figure 2–20. “Taxi-through” and “Back-out” Parking Position Marking: General Aviation.....	41
Figure 2–21. Parking Position Identification, Size, and Weight Limitations: General Aviation.....	43
Figure 2–22. Standard and Alternate TLOF Marking: General Aviation .....	46
Figure 2–23. Standard Heliport Identification Symbol, TLOF Size and Weight Limitations: General Aviation.....	47
Figure 2–24. Extended Pavement / Structure Marking: General Aviation .....	48
Figure 2–25. Paved TLOF/Paved FATO – Paved TLOF/ Unpaved FATO – Marking: General Aviation .....	49
Figure 2–26. Unpaved TLOF/Unpaved FATO – Marking: General Aviation .....	50
Figure 2–27. Marking a Closed Heliport: General Aviation.....	52
Figure 2–28. Elevated TLOF – Perimeter Lighting: General Aviation .....	53
Figure 2–29. TLOF/FATO Flush Perimeter Lighting: General Aviation.....	55
Figure 2–30. TLOF Flush and FATO Raised Perimeter Lighting: General Aviation .....	56
Figure 2–31. Landing Direction Lights: General Aviation.....	57
Figure 2–32. Airspace Where Marking and Lighting are Recommended: Straight Approach: General Aviation.....	59
Figure 2–33. Airspace Where Marking and Lighting are Recommended: Curved Approach: General Aviation.....	60
Figure 2–34. Caution Sign: General Aviation .....	62
Figure 2–35. Visual Glideslope Indicator Siting and Clearance Criteria: General Aviation.....	63
Figure 3–1. Typical Transport Heliport: Transport.....	66
Figure 3–2. TLOF/FATO Safety Area Relationships and Minimum Dimensions: Transport.....	68
Figure 3–3. Elongated FATO with Two Takeoff Positions: Transport .....	69
Figure 3–4. Elevated Heliport: Transport .....	70
Figure 3–5. Additional FATO Length for Heliports at Higher Elevations: Transport .....	71
Figure 3–6. Non-load-bearing Safety Area: Transport .....	74
Figure 3–7. VFR Heliport Approach/Departure and Transitional Surfaces: Transport.....	75

Figure 3–8. Curved Approach/Departure: Transport.....	78
Figure 3–9. Flight Path Alignment Marking and Lights: Transport .....	79
Figure 3–10. Heliport Protection Zone: Transport.....	80
Figure 3–11. Taxiway/Taxi Route Relationship, Centerline and Edge Marking: Transport .....	81
Figure 3–12. “Turn-around” Helicopter Parking Position Marking: Transport.....	82
Figure 3–13. “Taxi-through” Helicopter Parking Position Marking: Transport.....	83
Figure 3–14. Parking Area Design – “Turn-around” Parking Positions: Transport .....	85
Figure 3–15. Parking Area Design – “Taxi-through” Parking Position.....	86
Figure 3–16. Parking Position Identification, Size and Weight Limitations: Transport.....	87
Figure 3–17. Standard Heliport Identification Symbol, TLOF Size and Weight Limitations: Transport ..	89
Figure 3–18. Paved TLOF/Paved FATO – Paved TLOF/Unpaved FATO – Marking: Transport .....	90
Figure 3–19. Marking a Closed Heliport: Transport.....	93
Figure 3–20. TLOF and FATO Flush Perimeter Lighting: Transport .....	94
Figure 3–21. FATO Raised and TLOF Flush Perimeter Lighting: Transport .....	95
Figure 3–22. Optional TLOF Lights: Transport .....	97
Figure 3–23. Elevated FATO – Perimeter Lighting: Transport.....	98
Figure 3–24. Landing Direction Lights: Transport.....	99
Figure 3–25. Airspace Where Marking and Lighting are Recommended: Straight Approach: Transport	101
Figure 3–26. Airspace Where Marking and Lighting are Recommended: Curved Approach: Transport	102
Figure 3–27. Caution Sign: Transport.....	104
Figure 3–28. Visual Glideslope Indicator Siting and Clearance Criteria: Transport .....	106
Figure 4–1. Essential Features of a Ground-level Hospital Heliport: Hospital .....	110
Figure 4–2. TLOF/FATO Safety Area Relationships and Minimum Dimension: Hospital .....	111
Figure 4–3. Elongated FATO with Two Takeoff Positions: Hospital .....	113
Figure 4–4. Additional FATO Length for Heliports at Higher Elevation: Hospital .....	115
Figure 4–5. Rooftop Hospital Heliport: Hospital.....	117
Figure 4–6. VFR Heliport Approach/Departure and Transitional Surfaces: Hospital.....	119
Figure 4–7. Curved Approach/Departure: Hospital .....	120
Figure 4–8. VFR Heliport Lateral Extension of the 8:1 Approach / Departure Surface: Hospital .....	121
Figure 4–9. VFR Heliport Lateral Extension of the Curved 8:1 Approach/Departure Surface: Hospital	122
Figure 4–10. Flight Path Alignment Marking and Lights: Hospital .....	124
Figure 4–11. Heliport Protection Zone: Hospital.....	125
Figure 4–12. Taxiway/Taxi Route Relationship – Paved Taxiway: Hospital.....	127
Figure 4–13. Taxiway/Taxi Route Relationship – Unpaved Taxiway with Raised Edge Markers: Hospital	128
.....	
Figure 4–14. Taxiway/Route Relationship – Unpaved Taxiway with Flush Edge Markers: Hospital .....	129
Figure 4–15. Parking Area Design – “Taxi-through” Parking Positions: Hospital .....	132
Figure 4–16. Parking Area Design – “Turn-around” Parking Positions: Hospital .....	133
Figure 4–17. Parking Area Design – “Back-out” Parking Positions: Hospital.....	134
Figure 4–18. “Turn-around” Helicopter Parking Position Marking: Hospital.....	135
Figure 4–19. “Taxi-through” and “Back-out” Helicopter Parking Position Marking: Hospital .....	136
Figure 4–20. Parking Position Identification, Size, and Weight Limitations: General Aviation.....	137
Figure 4–21. Standard Hospital Heliport Identification Symbols: Hospital .....	139
Figure 4–22. Alternative Hospital Heliport Identification Symbols: Hospital .....	140
Figure 4–23. Paved TLOF/Paved FATO – Paved TLOF/Unpaved FATO – Marking: Hospital .....	141
Figure 4–24. Unpaved TLOF/Unpaved FATO – Marking: Hospital .....	142
Figure 4–25. TLOF Size and Weight Limitations: Hospital.....	144

Figure 4–26. Extended Pavement or Structure Marking: Hospital .....	145
Figure 4–27. Marking a Closed Heliport: Hospital.....	147
Figure 4–28. Flush TLOF/FATO Perimeter Lighting: Hospital .....	149
Figure 4–29. Elevated TLOF, Safety Net and Lighting Heliport Partial Elevation: Hospital .....	150
Figure 4–30. Flush TLOF and Raised FATO Perimeter Lighting: Hospital .....	151
Figure 4–31. Landing Direction Lights: Hospital .....	153
Figure 4–32. Airspace Where Marking and Lighting are Recommended: Hospital.....	155
Figure 4–33. Airspace Where Marking and Lighting are Recommended: Curved Approach: Hospital ..	156
Figure 4–34. Caution Sign: Hospital.....	158
Figure 4–35. Visual Glideslope Indicator Siting and Clearance Criteria: Hospital .....	160
Figure 5–1. Heliport Located on an Airport: On Airport.....	163
Figure 6–1. FARA/FATO Relationship: Precision.....	166
Figure 6–2. Heliport Instrument Lighting System (HILS): Non-precision.....	167
Figure 6–3. Heliport Approach Lighting System.....	168
Figure 7–1. Heliport Grades and Rapid Runoff Shoulder: Gradients and Pavement .....	170
Figure 7–2. Helicopter Landing Gear Loading: Gradients and Pavement .....	172
Figure 7–3. FATO Elevation .....	173
Figure A-1. Rooftop Emergency Landing Facility .....	177
Figure B–1. Helicopter Dimensions.....	184
Figure C–1. Form and Proportions of 36 Inch (91 cm) Numbers for Marking Size and Weight Limitations .....	185
Figure C–2. Form and Proportions of 18 Inch (45.7 cm) Numbers for Marking Size and Weight Limitation .....	186

### LIST OF TABLES

Table 2-1. Minimum VFR Safety Area Width as a Function of General Aviation and PPR Heliport Markings.....	15
Table 2-2. Taxiway/Taxi Route Dimensions – General Aviation Heliports.....	36
Table 3-1. Taxiway and Taxi Route Dimensions – Transport Heliports .....	77
Table 4-1. Minimum VFR Safety Area Width as a Function of Hospital Heliport Markings.....	116
Table 4-2. Taxiway / Taxi Route Dimensions – Hospital Heliports.....	130
Table 5-1. Recommended Distance between FATO Center to Runway Centerline for VFR Operations	161



## Chapter 1. Introduction

**101. Background.** Section 103 of the Federal Aviation Act of 1958 states in part, “In the exercise and performance of his power and duties under this Act, the Secretary of Transportation shall consider the following, among other things, as being in the public interest: (a) The regulation of air commerce in such manner as to best promote its development and safety and fulfill the requirements of defense; (b) The promotion, encouragement, and development of civil aeronautics . . .” This public charge, in effect, requires the development and maintenance of a national system of safe heliports. Using the standards and recommendations contained in this publication in the design of heliports supports this public charge. These standards and recommendations, however, do not limit or regulate the operations of aircraft. When it is not feasible to meet all the standards and recommendations in this AC, consult with the appropriate offices of the Federal Aviation Administration (FAA) Office of Airports and Flight Standards Service to identify any adjustments to operational procedures necessary to accommodate operations to the maximum extent.

**102. General.** This chapter provides an explanation of terms used in this AC, describes the notification responsibilities of heliport proponents to FAA, provides general siting guidance, and identifies sources of technical information relating to heliport planning and design of a civil heliport.

**103. Facilities.** While heliports can be large and elaborate, most are not. The basic elements of a heliport are clear approach/departure paths, a clear area for ground maneuvers, final approach and takeoff area (FATO), touchdown and liftoff area (TLOF), safety area, and a wind cone. This minimal facility may be adequate as a private use prior permission required (PPR) heliport, and may even suffice as the initial phase in the development of a public use heliport capable of serving the general aviation segment of the helicopter community.

**104. Planning.** While the heliport itself may be simple, the planning and organization required to properly put one into place can be intimidating. Consider the physical, technical, and public interest matters described in this document in the planning and establishment of a heliport. While this AC is a technical document intended to help engineers, architects, and city planners design, locate, and build the most effective heliport, anyone considering the construction of a heliport can use it. Figures in this document are general representations and are not to scale.

**105. Existing heliports.** When a change to an existing heliport requires the submission of FAA Form 7460-1, Notice of Proposed Construction or Alteration, or FAA Form 7480-1, Notice of Landing Area Proposal, bring the heliport up to current standards. It may not, however, be feasible to meet all current standards at existing heliports. In those cases, consult with the appropriate offices of the FAA Office of Airports and Flight Standards Service to identify any adjustments to operational procedures necessary to accommodate operations to the maximum extent.

**106. Location.** The optimum location for a heliport is near the desired origination and/or destination of the potential users. Industrial, commercial, and business operations in urban locations are demand generators for helicopter services, even though they often compete for the limited ground space available. Heliport sites may be adjacent to a river or a lake, a railroad, a freeway, or a highway, all of which offer the potential for multi-functional land usage. These locations also have the advantage of relatively unobstructed airspace, which can be further protected from unwanted encroachment by properly enacted zoning. As vertical flight transportation becomes more prevalent, requirements for scheduled “airline type” passenger services may necessitate the development of an instrument procedure to permit “all-weather” service.

**107. AC organization.** This AC is structured to provide communities and persons intending to develop a heliport, or become involved in regulating helicopter facilities, with general guidance on heliport requirements. The AC covers general aviation heliports (including PPR), transport heliports, hospital heliports, and emergency landing facilities. It is important for a heliport proponent to be familiar with the terminology used in this specialized field. This chapter defines terms used in the industry and identifies actions common to developing a heliport.

**a. General aviation heliports.** The term “general aviation” is technically defined as “flights conducted by operators other than Title 14 of the Code of Federal Regulations (CFR) Part 121 or Part 135 certificate holders.”<sup>1</sup> However, for the purposes of this AC, “general aviation” refers to all helicopter operations other than scheduled passenger service. Hospital heliports and emergency landing facilities fall under general aviation, but are treated separately in the AC due to their unique requirements. General aviation heliports are normally privately owned although they can be publicly owned. Find design standards for general aviation heliports in Chapter 2.

**b. Transport heliports.** Transport heliports will provide the community with a full range of vertical flight services including scheduled service by air carriers (airlines) using helicopters. These operations will require a more extensive airside and landside infrastructure with the potential capability to operate in instrument meteorological conditions. Find design standards for transport heliports in Chapter 3.

**c. Hospital heliports.** Hospital heliports are general aviation heliports that provide a unique public service. They are normally located close to the hospital emergency room or a medical facility. Find design standards for hospital heliports in Chapter 4.

**d. Helicopter facilities on airports.** When there are a significant number of helicopter operations on an airport, consider developing separate facilities specifically for helicopter use. Chapter 5 addresses helicopter facilities on airports.

**e. Instrument operations.** With the introduction of the global positioning system (GPS), it is now practical for heliports to have instrument approach procedures. Good planning suggests that heliport proponents plan for the eventual development of instrument approaches to their heliports. Consider the recommendations in Chapter 6 in contemplating future instrument operations at a heliport. It is wise to consider these issues during site selection and design.

**f. Heliport gradients and pavement design.** Chapter 7 addresses heliport gradients and pavement design issues.

**g.** The appendices provide information about emergency helicopter landing facilities, helicopter dimensional data, form and proportions of certain heliport markings, and a list of publications and resources referenced in this AC.

**108. Explanation of terms.** The Pilot/Controller Glossary of the Aeronautical Information Manual (AIM) defines terms used in the Air Traffic System. Copies of the AIM are available from the FAA web site <http://www.faa.gov/atpubs>. Other terms used in this publication follow:

**a. Air taxi.** Used both to refer to on-demand air carriers and as a synonym for “hover taxi.” See hover taxi.

**b. Approach/departure path.** The flight track helicopters follow when landing at or departing from a heliport. The approach/departure paths may be straight or curved.

---

<sup>1</sup>Plane Sense General Aviation Information, U.S. Department of Transportation FAA-H-8083-19A, <http://www.faa.gov/library/manuals/aviation/media/faq-h-8083-19A.pdf>

**c. Design helicopter.** A single or composite helicopter that reflects the maximum weight, maximum contact load/minimum contact area, overall length (D), rotor diameter (RD), tail rotor arc radius, undercarriage dimensions, and pilot's eye height of all helicopters expected to operate at the heliport.

**d. D (Formerly "OL").** The overall length of the helicopter, which is the dimension from the tip of the main or forward rotor to the tip of the tail rotor, fin, or other rear-most point of the helicopter. This value is with the rotors at their maximum extension. See Figure B-1. If only the value of the rotor diameter (RD) is known, estimate the value for D using the relationship  $D = 1.2 RD$  (or conversely,  $RD = 0.83 D$ ).

**e. Design loads.** Design and construct the TLOF and any load-bearing surfaces to support the loads imposed by the design helicopter and any ground support vehicles and equipment.

**(1) Static load.** For design purposes, the design static load is equal to the helicopter's maximum takeoff weight applied through the total contact area of the wheels or skids. See paragraph 707.

**(2) Dynamic load.** For design purposes, assume the dynamic load at 150 percent of the maximum takeoff weight of the design helicopter applied through the main undercarriage on a wheel-equipped helicopter or aft contact areas of skid-equipped helicopter. See paragraph 707.

**f. Elevated heliport.** A heliport located on a rooftop or other elevated structure where the TLOF is at least 30 inches (76 cm) above the surrounding surface (a ground level heliport with the TLOF on a mound is not an elevated heliport).

**g. Emergency helicopter landing facility (EHLF).** A clear area at ground level or on the roof of a building capable of accommodating helicopters engaged in fire fighting and/or emergency evacuation operations. An EHLF meets the definition of a heliport in this AC and under Title 14 CFR Part 157, Notice of Construction, Alteration, Activation, and Deactivation of Airports.

**h. Final approach and takeoff area (FATO).** A defined area over which the pilot completes the final phase of the approach to a hover or a landing and from which the pilot initiates takeoff. The FATO elevation is the lowest elevation of the edge of the TLOF. See Figure 7-3.

**i. Final approach reference area (FARA).** An obstacle-free area with its center aligned on the final approach course. It is located at the end of a precision instrument FATO.

**j. Flush lights.** Where the term "flush lights" is specified in this AC, interpret it as including semi-flush lights.

**k. Frangible/frangibly mounted.** While there is no accepted standard for frangibility in regard to helicopter operations, remove all objects from a FATO or safety area except those of the lowest mass practicable and frangibly mounted to the extent practicable.

**l. General aviation heliport.** A heliport intended to accommodate individuals, corporations, helicopter air taxi operators, and public safety agencies. For the purposes of this AC, "general aviation" refers to all helicopter operations other than scheduled passenger service. Hospital heliports and emergency landing facilities fall under general aviation, but are treated separately in the AC due to their unique requirements.

**m. Ground taxi.** The surface movement of a wheeled helicopter under its own power with wheels touching the ground.

**n. Hazard to air navigation.** Any object having a substantial adverse effect upon the safe and efficient use of the navigable airspace by aircraft, upon the operation of air navigation facilities, or upon existing or planned airport/heliport capacity as determined by the FAA.

**o. Heliport.** The area of land, water, or a structure used or intended to be used for the landing and takeoff of helicopters, together with appurtenant buildings and facilities.

**p. Heliport elevation.** The highest point of the TLOF expressed as the distance above mean sea level.

**q. Heliport imaginary surfaces.** The imaginary planes defined in Title 14 CFR Part 77, Safe, Efficient Use, and Preservation of the Navigable Airspace, centered about the FATO and the approach/departure paths, which are used to identify the objects where notice to and evaluation by the FAA is required. Recommendations may include realignment of approach/departure paths or removal, lowering, marking and lighting of objects.

**r. Heliport layout plan.** The plan of a heliport showing the layout of existing and proposed heliport facilities including the approach/departure paths.

**s. Heliport protection zone (HPZ).** An area off the end of the FATO and under the approach/departure path intended to enhance the protection of people and property on the ground.

**t. Heliport reference point (HRP).** The geographic position of the heliport expressed as the latitude and longitude at:

(1) The center of the FATO, or the centroid of multiple FATOs, for heliports having visual and non-precision instrument approach procedures; or

(2) The center of the FARA when the heliport has a precision instrument procedure.

**u. Helistop.** A term sometimes used to describe a minimally developed heliport for boarding and discharging passengers or cargo. This AC does not use this term, as the design standards and recommendations this AC apply to all heliports.

**v. Hospital heliport.** A heliport limited to serving helicopters engaged in air ambulance, or other hospital related functions. A designated helicopter landing area located at a hospital or medical facility is a heliport and not a medical emergency site.

**w. Hover taxi (also called air taxi).** The movement of a wheeled or skid-equipped helicopter above the surface. Generally, this takes place at a wheel/skid height of 1 to 5 feet (0.3 to 1.5 m) and at a ground speed of less than 20 knots (37 km/h). For facility design purposes, assume a skid-equipped helicopter to hover-taxi.

**x. Landing position.** An area, normally located in the center of an elongated TLOF, on which the helicopter lands.

**y. Large helicopter.** A helicopter with a maximum takeoff weight of more than 12,500 lbs.

**z. Load-bearing area (LBA).** The portion of the FATO capable of supporting the dynamic load of the design helicopter.

**aa. Medical emergency site.** An unprepared site at or near the scene of an accident or similar medical emergency on which a helicopter may land to pick up a patient in order to provide emergency medical transport. A medical emergency site is not a heliport as defined in this AC.

**bb. Medium helicopter.** A helicopter with a maximum takeoff weight of 7,001 to 12,500 lbs.

**cc. Obstruction to air navigation.** Any fixed or mobile object, including a parked helicopter, of greater height than any of the heights or surfaces presented in subpart C of part 77 (see also paragraph 111 in this AC).

**dd. Overall length (D).** See D, paragraph 108.d.

**ee. Parking pad.** The paved center portion of a parking position.

**ff. Prior permission required (PPR) heliport.** A heliport developed for exclusive use of the owner and persons authorized by the owner and about which the owner and operator ensure all authorized pilots are thoroughly knowledgeable. These features include but are not limited to: approach/departure path characteristics, preferred heading, facility limitations, lighting, obstacles in the area, and size and weight capacity of the facility.

**gg. Public use heliport.** A heliport available for use by the general public without a requirement for prior approval of the owner or operator.

**hh. RD. Rotor Diameter.** The length of the main rotor, from tip to tip.

**ii. Rotor downwash.** The downward movement of air caused by the action of the rotating main rotor blades. When this air strikes the ground or some other surface, it causes a turbulent outflow of air from beneath the helicopter.

**jj. Safety area.** A defined area on a heliport surrounding the FATO intended to reduce the risk of damage to helicopters accidentally diverging from the FATO.

**kk. Shielded obstruction.** A proposed or existing obstruction that does not need to be marked or lighted due to its close proximity to another obstruction whose highest point is at the same or higher elevation.

**ll. Shoulder line.** A marking line perpendicular to a helicopter parking position centerline that is intended to provide the pilot with a visual cue to assist in parking.

**mm. Small helicopter.** A helicopter with a maximum takeoff weight of 7,000 lbs or less.

**nn. Tail rotor arc radius.** The distance from the hub of the main rotor to the outermost tip of the tail rotor or the rear-most point of the helicopter tail, whichever is farther.

**oo. Takeoff position.** An area, normally located on the centerline and at the ends of an elongated TLOF, from which the helicopter takes off. Typically, there are two such positions on an elongated TLOF, one at each end.

**pp. Taxi route.** An obstruction-free corridor established for the movement of helicopters from one part of a heliport/airport to another. A taxi route includes the taxiway plus the appropriate clearances on both sides.

**qq. Taxiway.** A marked route between the TLOF and other areas on the heliport. This AC defines two types of helicopter taxiways:

**(1) Ground taxiway.** A taxiway intended to permit the surface movement of a wheeled helicopter under its own power with wheels on the ground. The minimum dimensions defined for a ground taxiway may not be adequate for hover taxi.

**(2) Hover taxiway.** A taxiway intended to permit the hover taxiing of a helicopter.

**rr. Touchdown and liftoff area (TLOF).** A load-bearing, generally paved area, normally centered in the FATO, on which the helicopter lands and/or takes off.

**ss. Transport heliport.** A heliport intended to accommodate air carrier operators providing scheduled service.

**tt. Touchdown/positioning circle (TDPC) marking.** A circular marking located in the center of a TLOF or a parking position. When the pilot's seat is over the TDPC, the whole of the helicopter undercarriage will be within the TLOF or parking position and all parts of the helicopter rotor system will be clear of any obstacle by a safe margin.

**uu. Unshielded obstruction.** A proposed or existing obstruction that may need to be marked or lighted since it is not near another marked and lighted obstruction whose highest point is at the same or higher elevation.

**109. Selection of approach/departure paths.** Design heliports to the extent practicable for two approach/departure paths. Consider items such as the following in selecting the approach/departure paths:

**a. Wind.** Well-designed approach/departure paths permit pilots to avoid downwind conditions and minimize crosswind operations. Align the preferred flight approach/departure path, to the extent feasible, with the predominant wind direction. Base other approach/departure paths on the assessment of the prevailing winds or, when this information is not available, separate such flight paths and the preferred flight path by at least 135 degrees. If it is not feasible to provide complete coverage of wind through multiple approach/departure paths, operational limitations may be necessary under certain wind conditions. See paragraph 101.

**b. Obstructions.** In determining approach/departure paths, take into account the obstructions in the vicinity of the heliport and, in particular, those likely to be a hazard to air navigation. See paragraph 111.

**c. Environmental impacts.** In environmentally sensitive areas, select the final approach/departure path(s) to minimize any environmental impact, providing it does not decrease flight safety. See paragraph 113.

**110. Notification requirements.** Part 157 sets requirements for persons proposing to construct, activate, deactivate, or alter a heliport to give advance notice of their intent to the FAA. This includes changing the size or number of FATOs; adding, deleting, or changing an approach or departure route; or changing heliport status. An example of a heliport status change would be a change from private to public use or vice versa. When notification is required, file Form 7480-1 (see Figure 1-1) with the appropriate FAA Airports Regional or District Office at least 90 days before construction, alteration, deactivation, or change in use. See the FAA Airports web site at <http://www.faa.gov/airports/> for contact information.

**a.** Draw the heliport layout plan to scale showing key dimensions, such as the heliport elevation, TLOF size, FATO size, safety area size, distance from safety area perimeter to property edges, and approach/departure paths showing locations of buildings, trees, fences, power lines, obstructions (including elevations), schools, churches, hospitals, residential communities, waste disposal sites, and other significant features as specified on Form 7480-1 and as suggested in Figure 1-2.

**b.** The preferred type of location map is the 7.5-minute U.S. Geological Survey Quadrangle Map, available from the US Geological Survey at [nationalmap.gov](http://nationalmap.gov). Web-based maps are also acceptable. Show the location of the heliport site and the approach/departure paths on the map. Point out the heliport site on this map with an arrow. Indicate the latitude and longitude of the proposed heliport in North American Datum of 1983 (NAD-83) coordinates. See Figure 1-3.

**c. The FAA role.** The FAA will conduct an aeronautical study of the proposed heliport under part 157. Title 14 CFR Part 157.7, FAA determinations, states: "The FAA will conduct an aeronautical study of an airport proposal and, after consultations with interested persons, as appropriate, issue a determination to the proponent and advise those concerned of the FAA determination. The FAA will consider matters such as the effects the proposed action would have on existing or contemplated traffic patterns of neighboring airports; the effects the proposed action would have on the existing airspace structure and projected programs of the FAA; and the effects that existing or proposed manmade objects (on file with the FAA) and natural objects within the affected area would have on the airport proposal. While determinations consider the effects of the proposed action on the safe and efficient use of airspace by aircraft and the safety of persons and property on the ground, the determinations are only advisory. Except for an objectionable determination, each determination will contain a determination-void date to

facilitate efficient planning of the use of the navigable airspace. A determination does not relieve the proponent of responsibility for compliance with any local law, ordinance or regulation, or state or other federal regulation. Aeronautical studies and determinations will not consider environmental or land use compatibility impacts.”

Form approved OMB No. 2120-0036


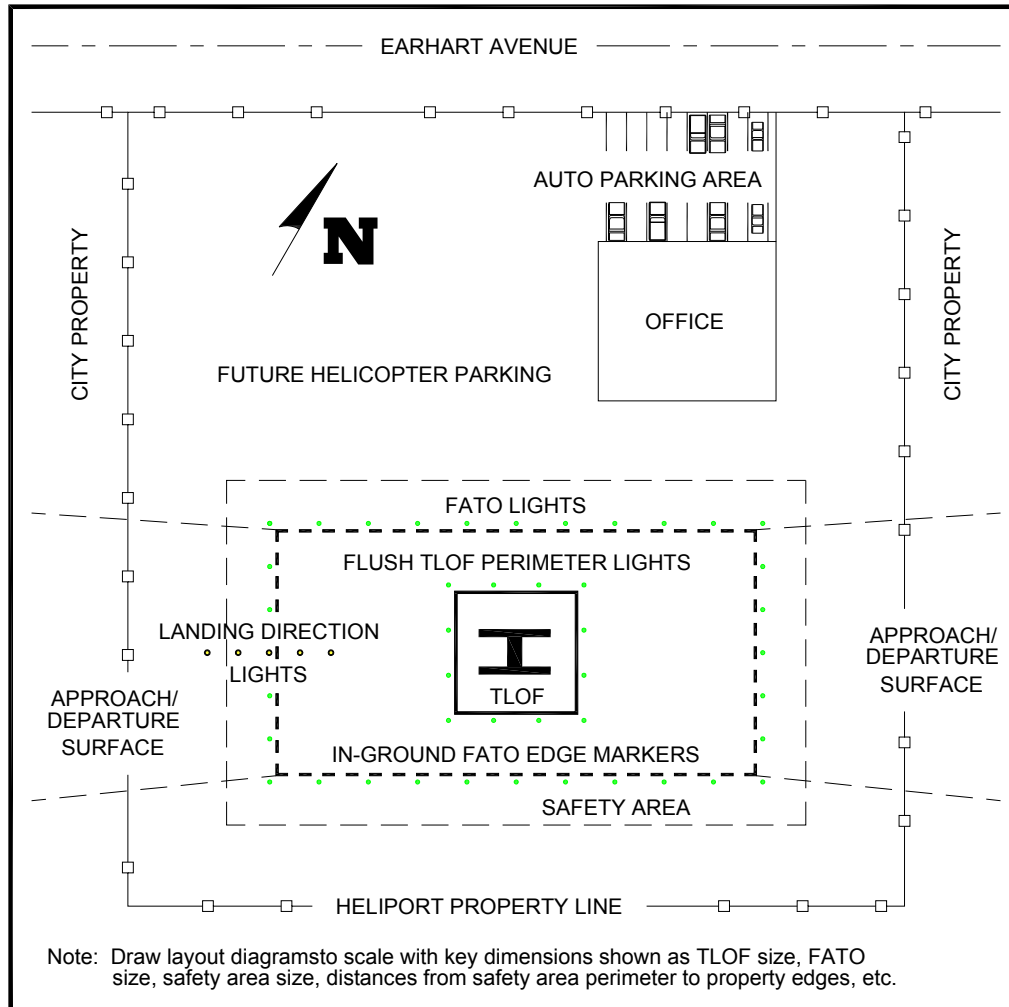
 U.S. Department of Transportation Federal Aviation Administration										NOTICE OF LANDING AREA PROPOSAL										
Name of Proponent, Individual, or Organization					Address of Proponent, Individual, or Organization (No., Street, City, State, Zip Code)					<input type="checkbox"/> Check if the property owner's name and address are different than above, and list property owner's name and address on the reverse.										
<input type="checkbox"/> Establishment or Activation <input type="checkbox"/> Alteration			<input type="checkbox"/> Deactivation or Abandonment <input type="checkbox"/> Change of Status			} OF			<input type="checkbox"/> Airport <input type="checkbox"/> Heliport		<input type="checkbox"/> Ultraflight Flightpark <input type="checkbox"/> Seaplane Base		<input type="checkbox"/> Vertiport <input type="checkbox"/> Other (Specify)							
A. Location of Landing Area										3. Distance and Direction From Associated City or Town										
1. Associated City/State					2. County/State (Physical Location of Airport)					Miles					Direction					
4. Name of Landing Area					5. Latitude					6. Longitude					7. Elevation					
B. Purpose										Construction Dates										
Type Use			If Change of Status or Alteration, Describe Change							<input type="checkbox"/> Establishment or change to traffic pattern (Describe on reverse)			To Begin/Began			Est. Completion				
<input type="checkbox"/> Public <input type="checkbox"/> Private <input type="checkbox"/> Private Use of Public Land/Waters																				
C. Other Landing Areas			Ref. A5 above		D. Landing Area Data							Existing (if any)			Proposed					
			Direction From Landing Area	Distance From Landing Area	1. Airport, Seaplane Base, or Flightpark							Rwy #1	Rwy #2	Rwy #3	Rwy	Rwy	Rwy			
					Magnetic Bearing of Runway (s) or Sealane															
					Length of Runway (s) or Sealane (s) in Feet															
					Width of Runway (s) or Sealane (s) in Feet															
					Type of Runway Surface (Concrete, Asphalt, Turf, Etc.)															
					2. Heliport															
					Dimensions of Final Approach and Take off Area (FATO) in Feet															
					Dimensions of Touchdown and Lift-Off Area (TLOF) in Feet															
					Magnetic Direction of Ingress/Egress Routes															
E. Obstructions			Direction From Landing Area		Distance From Landing Area		Type of Surface (Turf, concrete, rooftop, etc.)													
Type		Height Above Landing Area																		
							3. All Landing Areas							Description of Lighting (If any)			Direction of Prevailing Wind			
F. Operational Data																				
1. Estimated or Actual Number Based Aircraft																				
Airport, Flightpark, Seaplane base			Present (If est. indicate by letter "E")		Anticipated 5 Years Hence		Heliport			Present (If est. indicate by letter "E")		Anticipated 5 Years Hence								
Multi-engine							Under 3500 lbs. MGW													
Single-engine							Over 3500 lbs. MGW													
Glider																				
G. Other Considerations			Direction From Landing Area		Distance From Landing Area		2. Average Number Monthly Landings													
Identification							Present (If est. indicate by letter "E")		Anticipated 5 Years Hence		Present (If est. indicate by letter "E")			Anticipated 5 Years Hence						
							Jet		Helicopter											
							Turboprop		Ultraflight											
							Prop		Glider											
3. Are IFR Procedures For The Airport Anticipated																				
<input type="checkbox"/> No <input type="checkbox"/> Yes    Within _____ Years    Type Navaid:																				
H. Application for Airport Licensing																				
<input type="checkbox"/> Has Been Made <input type="checkbox"/> Will Be Made			<input type="checkbox"/> Not Required <input type="checkbox"/> State			<input type="checkbox"/> County <input type="checkbox"/> Municipal Authority														
I. CERTIFICATION: I hereby certify that all of the above statements made by me are true and complete to the best of my knowledge.																				
Name, title (and address if different than above) of person filing this notice -- type or print							Signature (in ink)													
							Date of Signature				Telephone No. (Precede with area code)									

Figure 1–1. Form 7480-1, Notice of Landing Area Proposal



**Figure 1-2. Example of a Heliport Layout Plan**

**d. Penalty for failure to provide notice.** Persons who fail to give notice are subject to civil penalty under Title 49 United States Code 46301, Civil Penalties, of not more than \$25,000 (or \$1,100 if the person is an individual or small business concern).

**e. Notice exemptions.** Paragraph 157.1, Applicability, of part 157 exempts sites meeting one of the conditions below from the requirement to submit notice. These exemptions do not negate a notice or formal approval requirement prescribed by state law or local ordinance. For the purposes of applying the part 157 exemption criteria cited in (2) and (3) below, a landing and associated takeoff is considered to be one operation. Part 157.1 projects are:

(1) [A heliport] subject to conditions of a federal agreement that requires an approved current heliport layout plan to be on file with the FAA, or

(2) [A heliport] at which flight operations will be conducted under visual flight rules (VFR) and which is used or intended to be used for a period of less than 30 consecutive days with no more than 10 operations per day.



(3) The intermittent use of a site that is not an established airport, that is used or intended to be used for less than 1 year, and at which flight operations will be conducted only under VFR. For the purpose of this part, “intermittent use of a site” means:

(a) the site is used or is intended to be used for no more than 3 days in any one week and

(b) no more than 10 operations will be conducted in any one day at that site.

**111. Hazards to air navigation.** Part 77 establishes requirements for notification to the FAA of objects that may affect navigable airspace. It sets standards for determining obstructions to navigable airspace and provides for aeronautical studies of such obstructions to determine their effect on the safe and efficient use of airspace. Part 77 applies only to public airports and heliports, airports operated by a federal agency or the Department of Defense, and private airports and heliports with at least one FAA-approved instrument approach procedure. See Figure 1–4.

**a. FAA studies.**

(1) **Part 77.** Part 77 defines objects that are obstructions to surfaces. Presume these objects to be hazards unless an FAA study determines otherwise. The FAA conducts aeronautical studies to determine the physical and electromagnetic effect on the use of navigable airspace, air navigational facilities, public airports and heliports, and private airports and heliports with at least one FAA-approved instrument approach procedure. The FAA encourages public agencies to enact zoning ordinances to prevent man-made features from becoming hazards to navigation.

(2) **Part 157.** While the FAA performs aeronautical studies under part 157 (see paragraph 110.c), such studies do not identify hazards to private facilities that do not have an FAA-approved instrument approach.

**b. Mitigation of hazards.** You may mitigate the adverse effect of an object presumed or determined to be a hazard by:

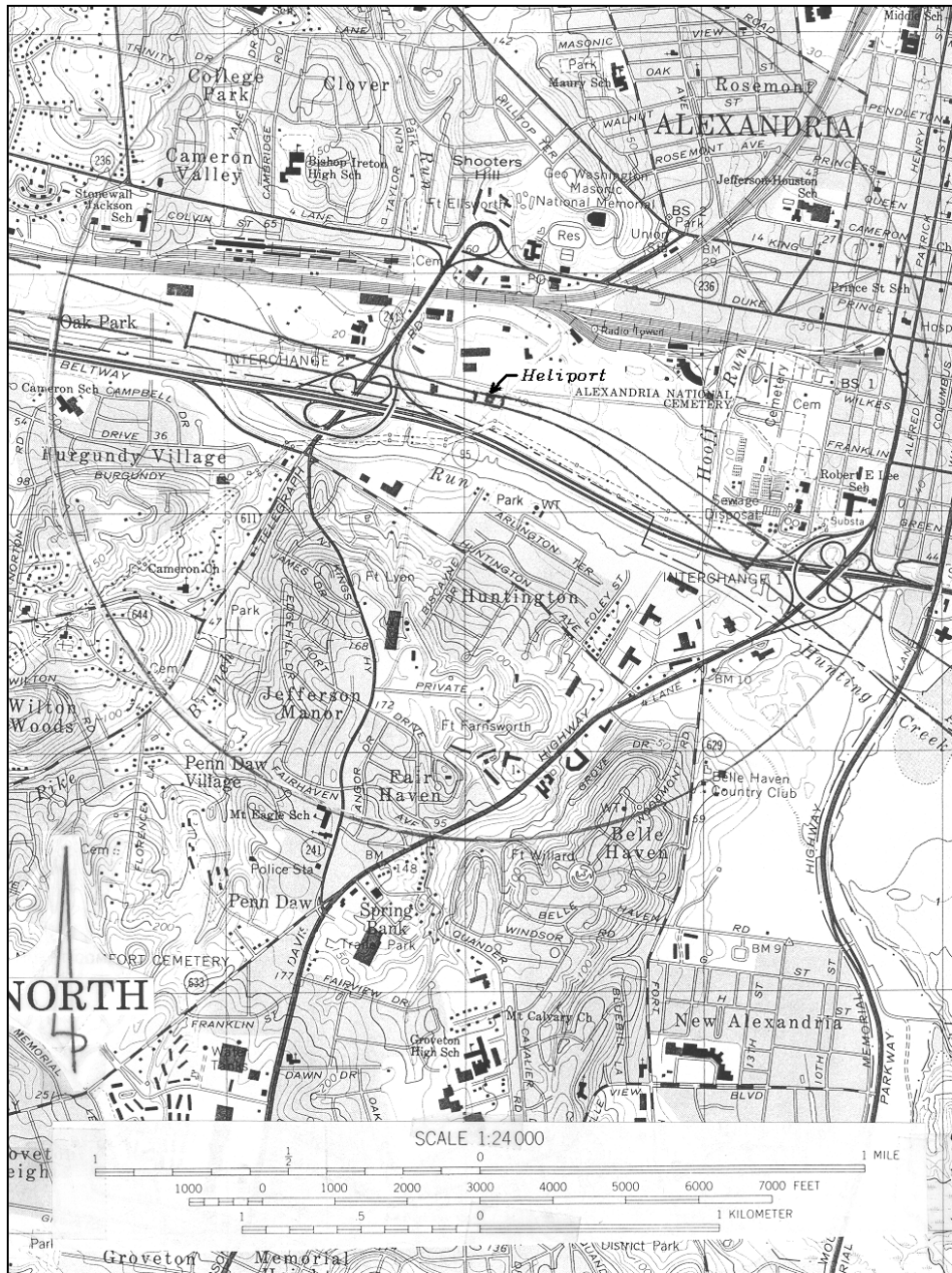
(1) Removing the object.

(2) Altering the object, for example, reducing its height.

(3) Marking and/or lighting the object, provided an FAA aeronautical study has determined that the object would not be a hazard to air navigation if it were marked and/or lighted. Find guidance on marking and lighting objects in AC 70/7460-1, Obstruction Marking and Lighting.

**c. Notification requirements.** Part 77 requires persons proposing certain construction or alteration to give 45-day notice to the FAA of their intent. Use FAA Form 7460-1, Notice of Proposed Construction or Alteration to provide notification. See <https://oeaaa.faa.gov> for more information and to download the form.

**d. Heliport development plans.** Future public heliport development plans and feasibility studies on file with the FAA may influence the determinations resulting from part 77 studies. Owners of public heliports and owners of private heliports with FAA-approved instrument approach procedures can ensure full consideration of future heliport development in part 77 studies only when they file plans with the FAA. Include in heliport plan data the coordinates and elevations of planned FATO(s), approach/departure paths including their azimuths, and types of approaches for any new FATO or modification of an existing FATO.



**Figure 1–3. Example of a Heliport Location Map**

**112. Federal assistance.** The FAA administers a grant program that provides financial assistance to eligible sponsors to develop a public use heliport. Information on federal aid program eligibility requirements is available from FAA Airports Regional and District Offices and on the FAA Airports web site, [www.faa.gov/airports](http://www.faa.gov/airports).

**113. Environmental impact analyses.** The National Environmental Policy Act of 1969 requires the FAA to consider potential environmental impacts prior to agency decision making, including, for example, the decision to fund or approve a project, plan, license, permit, certification, rulemaking, or operations specification, unless these actions are within an existing categorical exclusion and no

extraordinary circumstances exist. Actions that may require an environmental assessment are normally associated with federal grants or heliport layout plan approvals leading to the construction of a new heliport or significant expansion of an existing heliport.

**a. Assessment items.** An environmental assessment addresses noise, historic and cultural resources, wildlife, energy conservation, land usage, air quality, water quality, pollution prevention, light emissions and other visual effects, electromagnetic fields, other public health and safety issues, the “no action” alternative and a reasonable range of feasible alternatives, including mitigation not integrated into the alternative initially. It also describes the action taken to ensure public involvement in the planning process. An opportunity for a public hearing may be required for the federally funded development of, or significant improvement to, an existing heliport.

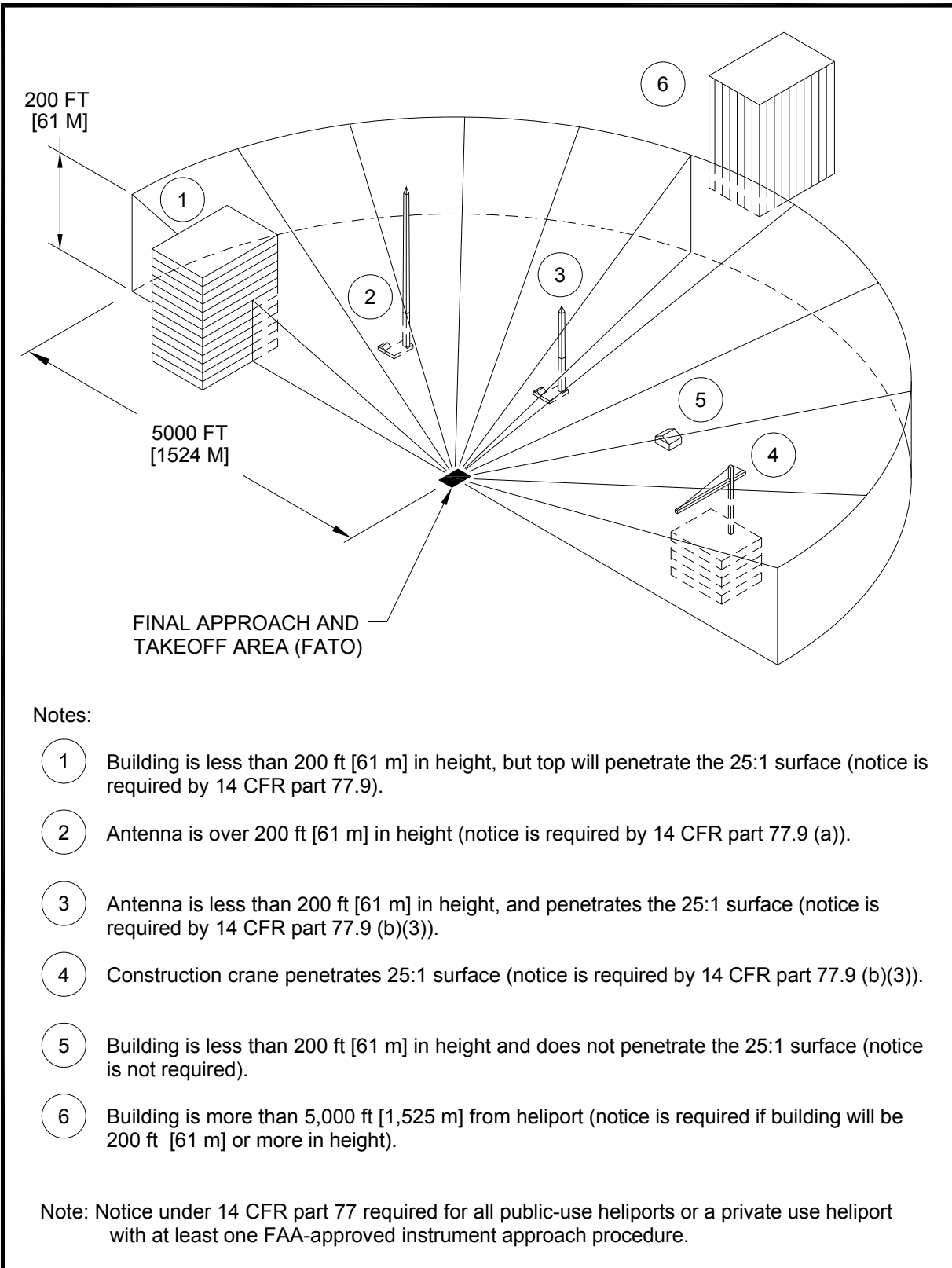
**b. Guidance.** FAA Order 5050.4, National Environmental Policy Act (NEPA) Implementing Instructions for Airport Projects, and FAA Order 1050.1, Policies and Procedures for Considering Environmental Impacts, and other supplemental guidance from FAA Air Traffic and Flight Standards provide guidance on environmental impact analysis. Contact state and local governments, including metropolitan planning organizations and local transit agencies, directly as they may also require an environmental report. The procedures in AC 150/5020-1, Noise Control and Compatibility Planning for Airports, describe a means of assessing the noise impact. Contact the appropriate FAA Airports Regional or District Office for current information related to assessing noise impact of heliports. Proponents of non-federally assisted heliports work with local governmental authorities concerning environmental issues.

**114. Access to heliports by individuals with disabilities.** Congress has passed various laws concerning access to airports. Since heliports are a type of airport, these laws are similarly applicable. Find guidance in AC 150/5360-14, Access to Airports by Individuals with Disabilities.

**115. State role.** Many state departments of transportation, aeronautical commissions, or similar authorities require prior approval and, in some instances, a license for the establishment and operation of a heliport. Several states administer a financial assistance program similar to the federal program and are staffed to provide technical advice. Contact your respective state aeronautics commissions or departments for particulars on licensing and assistance programs. Contact information for state aviation agencies is available at [http://www.faa.gov/airports/resources/state\\_aviation](http://www.faa.gov/airports/resources/state_aviation).

**116. Local role.** Some communities have enacted zoning laws, building codes, fire regulations, etc. that can affect heliport establishment and operation. Some have or are in the process of developing codes or ordinances regulating environmental issues such as noise and air pollution. A few localities have enacted specific rules governing the establishment of a heliport. Therefore, make early contact with officials or agencies representing the local zoning board, the fire, police, or sheriff's department, and the elected person(s) who represent the area where the heliport is to be located.

**117. Related referenced material.** Find a list of related and referenced publications in Appendix D.

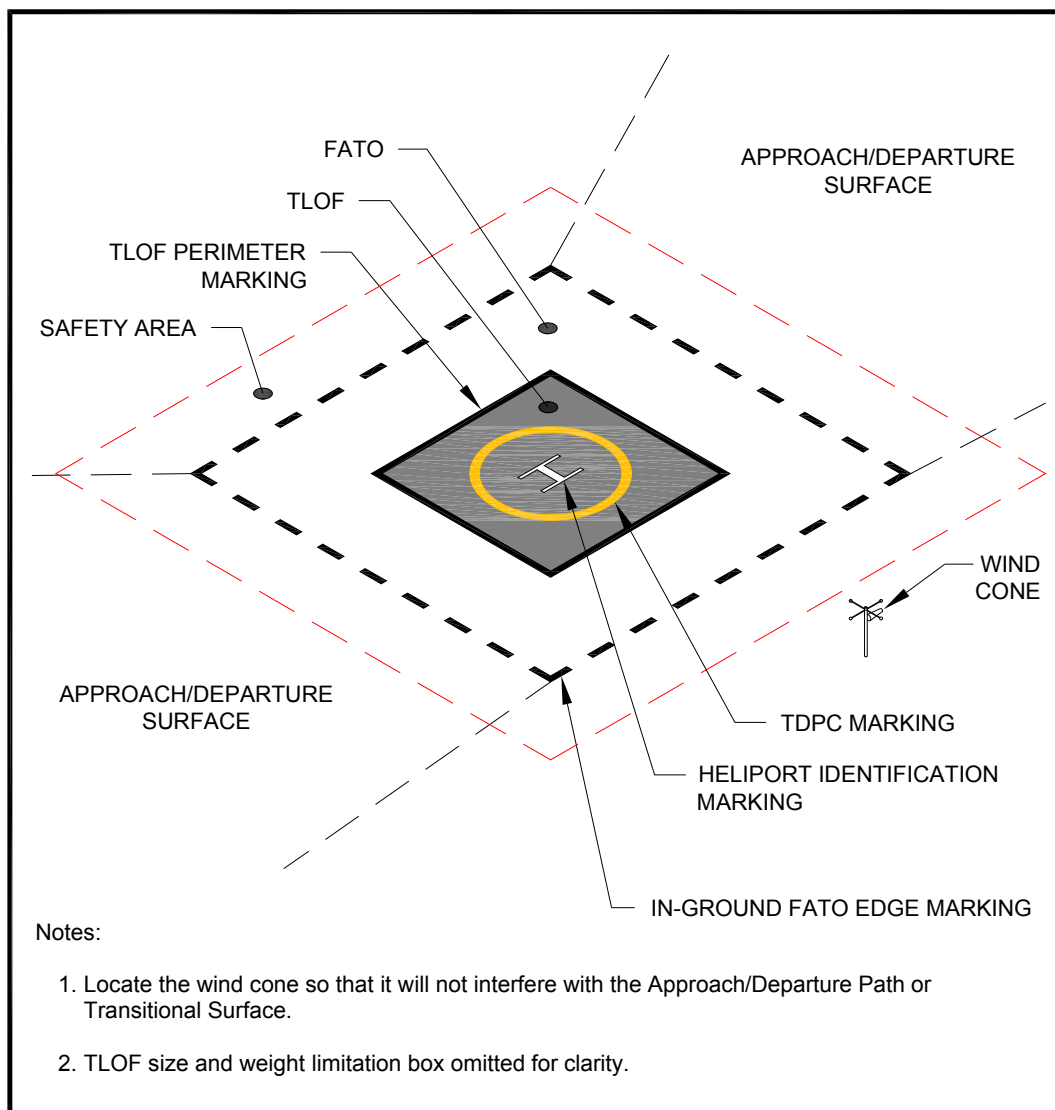


**Figure 1–4. Offsite Development Requiring Notice to the FAA**

## Chapter 2. General Aviation Heliports

**201. General.** A general aviation heliport accommodates helicopters used by individuals, corporations, and helicopter air taxi services. While general aviation heliports may be publicly owned, this is not required. Most general aviation heliports are privately owned.

**202. Applicability.** The standards in this chapter apply to projects funded under the Airport Improvement Program (AIP) or the Passenger Facility Charge (PFC) program. For other projects/heliports, these standards are the FAA's recommendations for designing all general aviation heliports. The design standards in this chapter assume that there will never be more than one helicopter within the final approach and takeoff area (FATO) and the associated safety area. If there is a need for more than one touchdown and liftoff area (TLOF) at a heliport, locate each TLOF within its own FATO and within its own safety area. Figure 2-1 illustrates the essential features of a general aviation heliport.



**Figure 2-1. Essential Features of a Heliport: General Aviation**

**203. Prior permission required (PPR) facilities.** The standards in this AC are recommended for all heliports. As PPR heliports are never eligible for federal financial assistance, do not interpret any recommendation in this AC that is not required by federal law or regulation as mandatory for PPR heliports. Recommendations for PPR heliports are provided in recognition of the unique nature of facilities where the operator ensures pilots are thoroughly familiar with the heliport, its procedures, and any facility limitations.

**204. Access by individuals with disabilities.** Various laws require heliports operated by public entities and those receiving federal financial assistance to meet accessibility requirements. See paragraph 114.

**205. Heliport site selection.**

**a. Long term planning.** The FAA encourages public agencies and others planning to develop a general aviation heliport to consider the possible future need for instrument operations and expansion.

**b. Property requirements.** The property needed for a general aviation heliport depends upon the volume and types of users, size of helicopters, and the scope of amenities provided. Property needs for helicopter operators and for passenger amenities frequently exceed those for “airside” purposes.

**c. Turbulence.** Air flowing around and over buildings, stands of trees, terrain irregularities, etc. can create turbulence on ground-level and roof-top heliports that may affect helicopter operations. Where the FATO is located near the edge and top of a building or structure, or within the influence of turbulent wakes from other buildings or structures, assess the turbulence and airflow characteristics in the vicinity of, and across the surface of the FATO to determine if an air-gap between the roof, roof parapet or supporting structure, and/or some other turbulence mitigating design measure is necessary. FAA Technical Report FAA/RD-84/25, Evaluating Wind Flow around Buildings on Heliport Placement, addresses the wind’s effect on helicopter operations. Take the following actions in selecting a site to minimize the effects of turbulence.

**(1) Ground-level heliports.** Features such buildings, trees, and other large objects can cause air turbulence and affect helicopter operations from sites immediately adjacent to them. Therefore, locate the landing and takeoff area away from such objects in order to minimize air turbulence in the vicinity of the FATO and the approach/departure paths.

**(2) Elevated heliports.** Establishing a 6 foot (1.8 m) or more air gap on all sides above the level of the roof will generally minimize the turbulent effect of air flowing over the roof edge. Keep air gaps free at all times of objects that would obstruct the airflow. If it is not practical to include an air gap or some other turbulence mitigating design measure where there is turbulence, operational limitations may be necessary under certain wind conditions. See paragraph 101.

**d. Electromagnetic effects.** Nearby electromagnetic devices, such as a large ventilator motor, elevator motor or other devices that consume large amounts of electricity may cause temporary aberrations in the helicopter magnetic compass and interfere with other onboard navigational equipment.

**206. Basic layout.** A basic heliport consists of a TLOF contained within a FATO. A safety area surrounds the FATO. Table 2-1 shows how the standards for safety area width vary as a function of heliport markings. The relationship of the TLOF to the FATO and the safety area is shown in Figure 2–2. A FATO contains only one TLOF. Provide appropriate approach/departure airspace to allow safe approaches to and departures from landing sites. To the extent feasible, align the preferred approach/departure path with the predominant winds. See paragraph 210.

**Table 2-1. Minimum VFR Safety Area Width  
as a Function of General Aviation and PPR Heliport Markings**

<b>General aviation heliports</b>	$\frac{1}{3}$ RD but not less than 20 ft (6 m)**	$\frac{1}{3}$ RD but not less than 30 ft (9 m)**	$\frac{1}{2}$ D but not less than 20 ft (6 m)	$\frac{1}{2}$ D but not less than 30 ft (9 m)
<b>PPR heliports</b>	$\frac{1}{3}$ RD but not less than 10 ft (3 m) **	$\frac{1}{3}$ RD but not less than 20 ft (6 m)**	$\frac{1}{2}$ D but not less than 20 ft (6 m)	$\frac{1}{2}$ D but not less than 30 ft (9 m)
<b>TLOF perimeter marked</b>	Yes	Yes	No	No
<b>FATO perimeter marked</b>	Yes	Yes	Yes	Yes
<b>Standard “H” marking</b>	Yes	No	Yes	No
D: Overall length of the design helicopter RD: Rotor diameter of the design helicopter ** Also applies when the FATO is not marked. Do not mark the FATO if (a) the FATO (or part of the FATO) is a non-load bearing surface and/or (b) the TLOF is elevated above the level of a surrounding load-bearing area.				

## 207. Touchdown and liftoff area (TLOF).

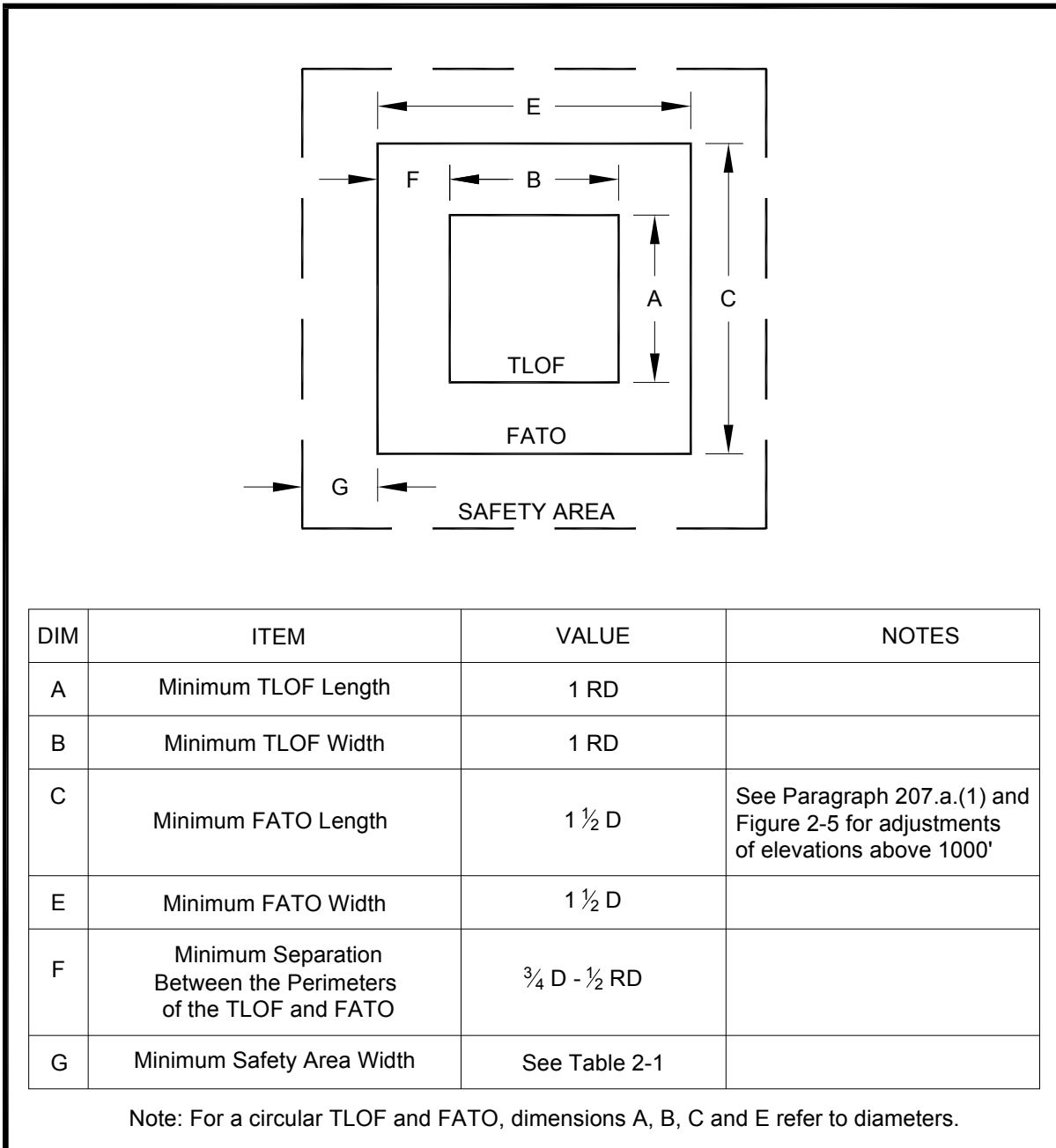
**a. TLOF location.** TLOFs of general aviation heliports are at ground level, on elevated structures, and at rooftop level. Center the TLOF within the FATO. At a PPR rooftop or other PPR elevated facility, where the entire FATO is not load-bearing, locating the TLOF in a load-bearing area (LBA) that is as large as possible may provide some operational advantages. In this case, locate the TLOF in the center of the LBA.

**b. TLOF size.** Design the TLOF so the minimum dimension (length, width, or diameter) is at least equal to the RD of the design helicopter (except as noted in (2) below). Design the TLOF to be rectangular or circular. Each has its advantages. A square or rectangular shape provides the pilot with better alignment cues than a circular shape, but a circular TLOF may be more recognizable in an urban environment. Increasing the LBA centered on the TLOF may provide some safety and operational advantages. At PPR facilities, if only a portion of the TLOF is paved, design the TLOF so the minimum length and width of this paved portion is not less than two times the maximum dimension (length or width) of the undercarriage of the design helicopter. Locate the center of the TLOF in the center of this paved portion. To avoid the risk of catching a skid and the potential for a dynamic rollover, make sure there is no difference in elevation between the paved and unpaved portions of the TLOF.

**(1) Elevated public general aviation heliport.** If the FATO outside the TLOF is not load-bearing, increase the minimum width, length or diameter of the TLOF to the overall length (D) of the design helicopter. See paragraph 207.b(3).

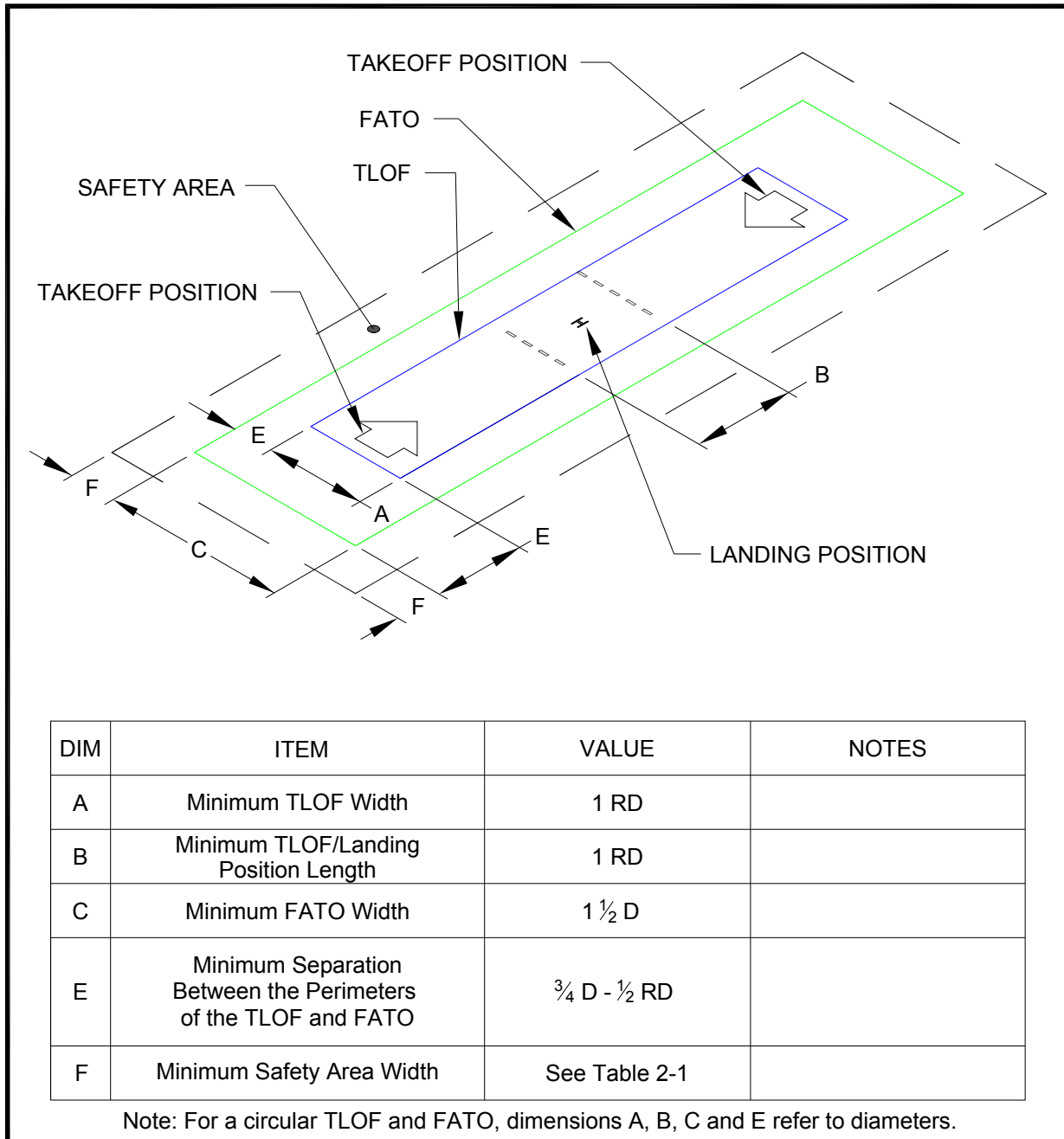
**(2) Elevated PPR heliports.** At PPR rooftop or elevated facilities where the height of the TLOF surface above the adjacent ground or structure is no greater than 30 inches (76 cm), and there is a solid adjacent ground or structure equal to the rotor diameter (RD) able to support 20 lbs/sq ft (98 kg/sq m) live load, design the minimum dimension of the TLOF to be at least the smaller of the RD and two times the maximum dimension (length or width) of the undercarriage of the design helicopter. Locate the center of the LBA of the TLOF in the center of the FATO.

**(3) Elongated TLOF.** An elongated TLOF can provide an increased safety margin and greater operational flexibility. As an option, design an elongated TLOF with a landing position in the center and two takeoff positions, one at either end. Design the landing position to have a minimum length equal to the RD of the design helicopter. If the TLOF is elongated, also provide an elongated FATO. Figure 2–3 shows an elongated TLOF and an elongated FATO.



**Figure 2-2. TLOF/FATO Safety Area Relationships and Minimum Dimensions:  
General Aviation**





**Figure 2-3. Elongated FATO with Two Takeoff Positions: General Aviation**

**c. Ground-level TLOF surface characteristics.**

**(1) Design loads.** Design the TLOF and any supporting TLOF structure to be capable of supporting the dynamic loads of the design helicopter.

**(2) Paving.** Provide either a paved or aggregate-turf surface for the TLOF (see AC 150/5370-10, Standards for Specifying Construction of Airports items P-217, Aggregate-Turf Pavement and P-501, Portland Cement Concrete Pavement). Use portland cement concrete (PCC) when feasible for ground-level facilities. An asphalt surface is less desirable for heliports as it may rut under the wheels or skids of

a parked helicopter. This has been a factor in some rollover accidents. Use a broomed or roughened pavement finish to provide a skid-resistant surface for helicopters and non-slippery footing for people. For PPR heliports where only a portion of the TLOF is paved, design the paved portion to dynamic load-bearing. Design the adjacent ground or structure of the TLOF for the static loads of the design helicopter.

**d. Rooftop and other elevated TLOFs.**

**(1) Design loads.** Design elevated TLOFs and any TLOF supporting structure to capable of supporting the dynamic loads of the design helicopter described in paragraph 707.b. An elevated heliport is illustrated in Figure 2-4.

**(2) Elevation.** Elevate the TLOF above the level of any obstacle in the FATO and safety area that cannot be removed.

**(3) Obstructions.** Elevator penthouses, cooling towers, exhaust vents, fresh-air vents, and other raised features can affect heliport operations. Establish control mechanisms to ensure obstruction hazards are not installed after the heliport is operational.

**(4) Air quality.** Helicopter exhaust can affect building air quality if the heliport is too close to fresh air vents. When designing a building intended to support a helipad, locate fresh air vents accordingly. When adding a heliport to an existing building, relocate fresh air vents if necessary or, if that is not practical, installing charcoal filters or a fresh air intake bypass louver system for HVAC systems may be adequate.

**(5) TLOF surface characteristics.** Construct rooftop and other elevated heliport TLOFs of metal or concrete (or other materials subject to local building codes). Use a finish for TLOF surfaces that provides a skid-resistant surface for helicopters and non-slippery footing for people.

**(6) Safety net.** If the platform is elevated 4 feet (1.2 m) or more above its surroundings, Title 29 CFR Part 1910.23, Guarding Floor and Wall Openings and Holes, requires the provision of fall protection. The FAA recommends such protection for all platforms elevated 30 inches (76 cm) or more. However, do not use permanent railings or fences since they would be safety hazards during helicopter operations. As an option, install a safety net meeting state and local regulations but not less than 5 feet (1.5 m) wide. Design the safety net to have a load carrying capability of 25 lbs/sq ft (122 kg/sq m). Make sure the net, as illustrated in Figure 2-28, does not project above the level of the TLOF. Fasten both the inside and outside edges of the safety net to a solid structure. Construct nets of materials that are resistant to environmental effects.

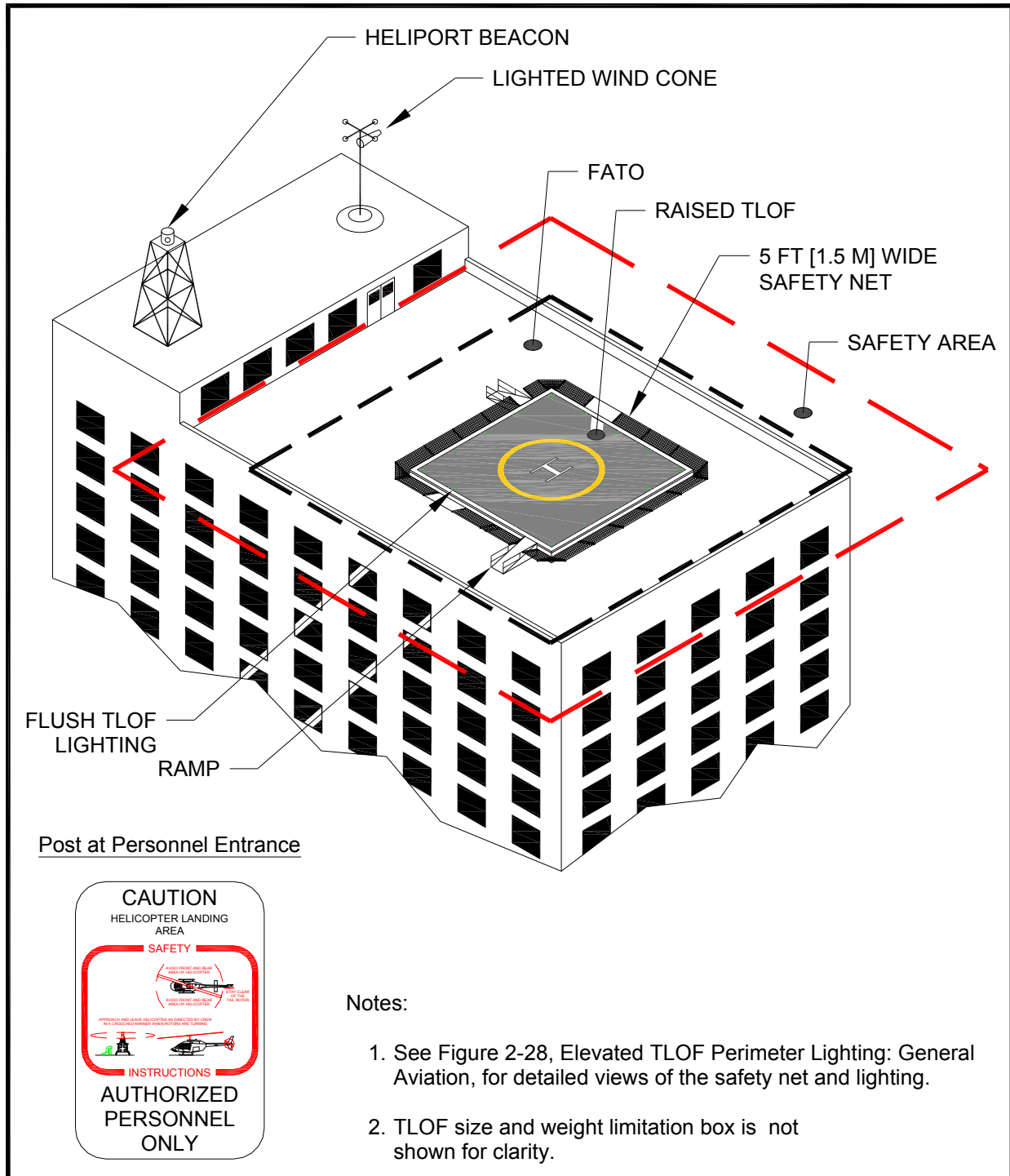


Figure 2-4. Elevated Heliport: General Aviation

(7) **Access to elevated TLOFs.** Title 29 CFR Part 1926.34, Means of Egress, requires two separate access points for an elevated structure such as one supporting an elevated TLOF. Title 29 CFR Part 1910.24, Fixed Industrial Stairs applies to stairs. Design handrails required by this regulation to fold down or be removable to below the level of the TLOF so they will not be hazards during helicopter operations.

e. **TLOF gradients.** See paragraph 702 for TLOF gradient standards.

**208. Final approach and takeoff area (FATO).** A general aviation heliport has at least one FATO. The FATO contains a TLOF within its borders at which arriving helicopters terminate their approach and from which departing helicopters take off.

a. **FATO size.**

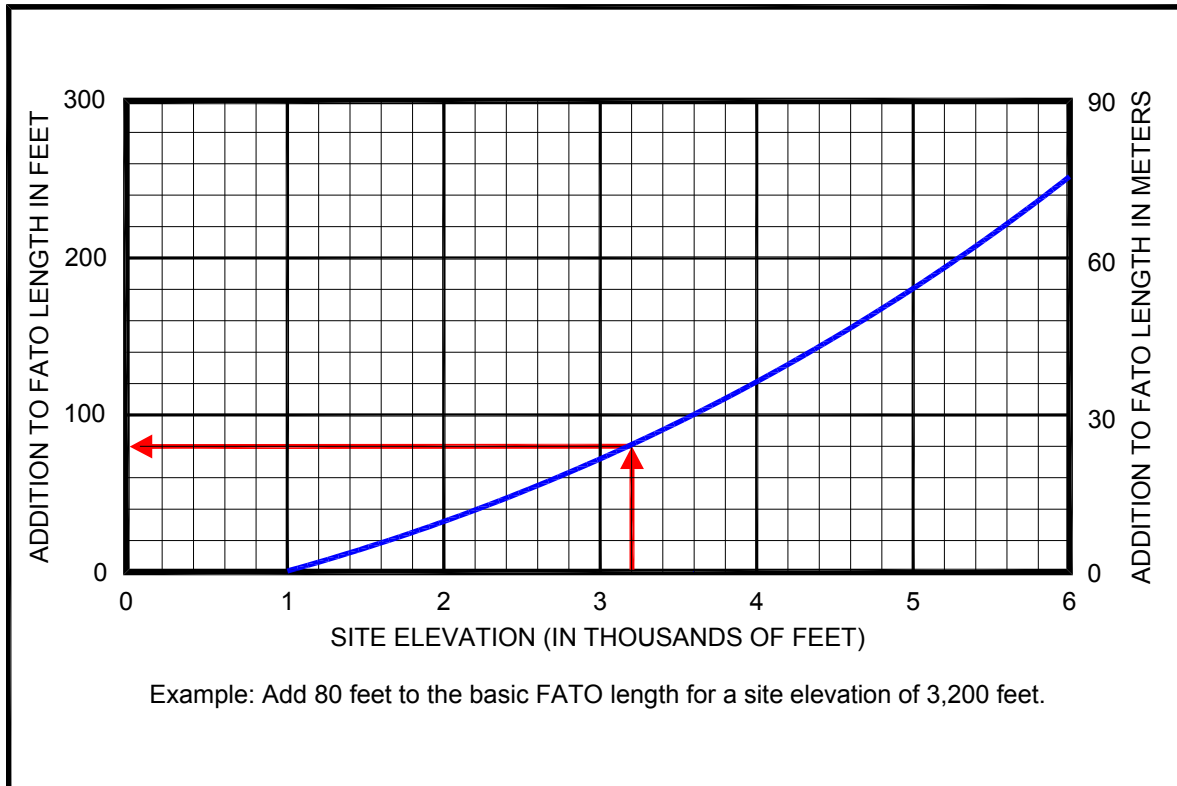
(1) Design the minimum width, length, or diameter of a FATO to be at least 1.5 times the overall length (D) of the design helicopter. Design the FATO to be circular or rectangular, regardless of the shape of the TLOF. At elevations above 1,000 feet MSL, include a longer, rectangular FATO to provide an increased safety margin and greater operational flexibility. Use the additional FATO length depicted in Figure 2–5. Where the operator of a PPR heliport chooses not to provide additional FATO length, the operator makes sure that all pilots using the facility are thoroughly knowledgeable with this and any other facility limitations.

(2) Design the minimum distance between the TLOF perimeter and the FATO perimeter to be not less than the distance ( $\frac{3}{4}D - \frac{1}{2}RD$ ) where D is the overall length and RD is the rotor diameter of the design helicopter. Note that if the TLOF and FATO are not of similar shape, this applies at all points of the TLOF perimeter. The relationship of the TLOF to the FATO and the safety area is shown in Figure 2–2.

b. **FATO surface characteristics.** If the heliport operator marks the TLOF, the FATO outside the TLOF need not load-bearing.

(1) **Ground level public general aviation heliports.** If the heliport operator does not mark the TLOF (see paragraph 215.a), and/or intends that the helicopter be able to land anywhere within the FATO, design the FATO outside the TLOF and any FATO supporting structure, like the TLOF, to be capable of supporting the dynamic loads of the design helicopter, as described in paragraph 707.b.

(2) **Ground level PPR heliports.** If the heliport operator does not mark the TLOF, and/or intends for the helicopter to be able to land anywhere within the FATO, design the FATO outside the TLOF and any FATO supporting structure, like the TLOF, to be capable of supporting the dynamic loads of the design helicopter, as described in paragraph 707.b.



**Figure 2–5. Additional FATO Length for Helicopters at Higher Elevations:  
General Aviation**

**(3) Elevated helicopters.** As an option, design the FATO outside the TLOF to extend into clear airspace. However, there are some helicopter performance benefits and increased operational flexibility if the FATO outside the TLOF is load bearing. Design the FATO outside of the TLOF to be load-bearing, or increase the minimum width and length or diameter of TLOF to the overall length of the design helicopter.

**(4) Elevated PPR helicopters.** For elevated PPR helicopters, if the heliport operator intends to mark the TLOF, as an option design the FATO outside the TLOF and the safety area to extend into the clear airspace (see Figure 2–4). If the heliport operator does not mark the TLOF, and/or intends that the helicopter be able to land anywhere within the FATO, design the FATO outside the TLOF and any FATO supporting structure, like the TLOF, to support the dynamic loads of the design helicopter. As an option, increase the length and width or diameter of the LBA without a corresponding increase in the size of the FATO.

**(5)** If the FATO is load-bearing, design the portion abutting the TLOF to be contiguous with the TLOF, with the adjoining edges at the same elevation.

**(6)** If the FATO is unpaved, treat the FATO to prevent loose stones and any other flying debris caused by rotor downwash.

**(7)** When the FATO or the LBA in which it is located is elevated 4 feet (1.2 m) or more above its surroundings, part 1910.23 requires the provision of fall protection. The FAA recommends such protection for all platforms elevated 30 inches (76 cm) or more. However, do not use permanent railings or fences since they would be safety hazards during helicopter operations. As an option, install a safety net meeting state and local regulations but not less than 5 feet (1.5 m) wide. Design the safety net to have a load carrying capability of 25 lbs/sq ft (122 kg/sq m). Make sure the net, as illustrated in Figure 2–28,

does not project above the level of the TLOF. Fasten both the inside and outside edges of the safety net to a solid structure. Construct nets of materials that are resistant to environmental effects.

**c. Mobile objects within the FATO.** The FATO design standards of this AC assume the TLOF and FATO are closed to other aircraft if a helicopter or other mobile object is within the FATO or the safety area.

**d. Fixed objects within the FATO.** Remove all fixed objects projecting above the FATO elevation except for lighting fixtures, which may project a maximum of 2 inches (5 cm). See Figure 7-3. For ground level heliports, remove all above-ground objects to the extent practicable.

**e. FATO/FATO separation.** If a heliport has more than one FATO, separate the perimeters of the two FATOs so the respective safety areas do not overlap. This separation assumes simultaneous approach/departure operations will not take place. If the heliport operator intends for the facility to support simultaneous operations, provide a minimum 200 foot (61 m) separation.

**f. FATO gradients.** See paragraph 703 for FATO gradient standards.

**209. Safety area.** A safety area surrounds a FATO.

**a. Safety area width.** The standards for the width of the safety area are shown in Table 2-1. The value is the same on all sides. The provision or absence of standard heliport markings affects the width standards. As an option, design the safety area to extend into clear airspace.

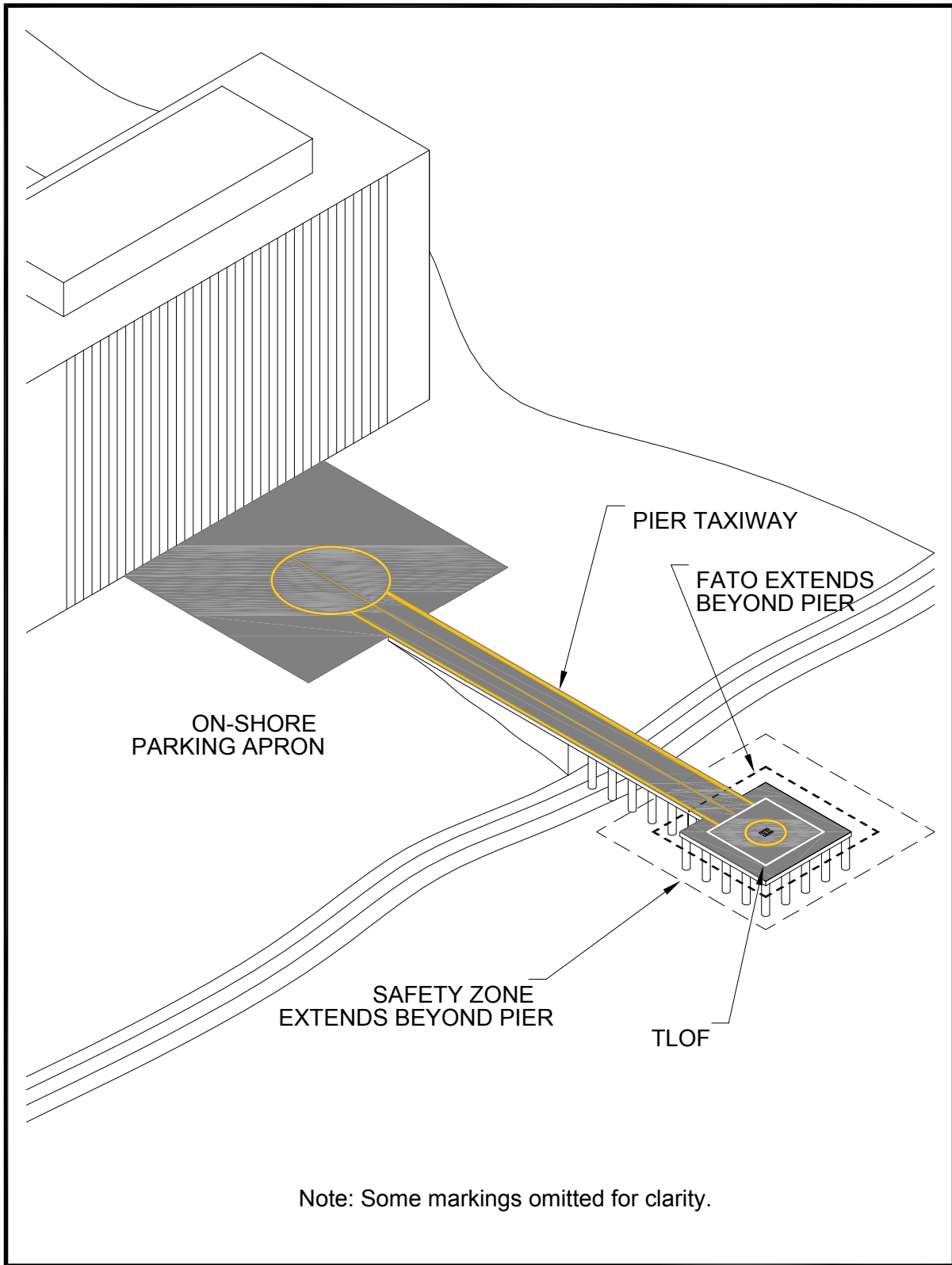
**b. Mobile objects within the safety area.** The safety area design standards of this AC assume the TLOF and FATO are closed to other aircraft if a helicopter or other mobile object is within the FATO or the safety area.

**c. Fixed objects within a safety area.** Remove all fixed objects within a safety area projecting above the FATO elevation except for lighting fixtures, which may project a maximum of 2 inches (5 cm). See Figure 7-3. For ground level heliports, remove all above-ground objects to the extent practicable.

**d. Safety area surface.** The safety area need not be load bearing. Figure 2-6 depicts a safety area extending over water. If possible, design the portion of the safety area abutting the FATO to be contiguous with the FATO with the adjoining edges at the same elevation. This is needed to avoid the risk of catching a helicopter skid or wheel. Clear the safety area of flammable materials and treat the area to prevent loose stones and any other flying debris caused by rotor wash.

**e. Safety area gradients.** Find safety area gradient standards in Chapter 7.

**210. VFR approach/departure paths.** The purpose of approach/departure airspace, shown in Figure 2-7 and Figure 2-8 is to provide sufficient airspace clear of hazards to allow safe approaches to and departures from the TLOF.



**Figure 2-6. Non-load-bearing FATO and Safety Area: General Aviation**

**a. Number of approach/departure paths.** Align preferred approach/departure paths with the predominant wind direction to avoid downwind operations and minimize crosswind operations. To accomplish this, design the heliport with more than one approach/departure path. Base other approach/departure paths on the assessment of the prevailing winds or, when this information is not available, separate such flight paths and the preferred flight path by at least 135 degrees. See Figure 2-7, Figure 2-8, and Figure 2-9. At a PPR heliport that has only one approach/departure path, the operator makes sure all pilots using the facility are thoroughly knowledgeable with this and any other facility limitations. A second flight path provides additional safety margin and operational flexibility. If it is not feasible to provide complete coverage of wind through multiple approach/departure paths, operational limitations may be necessary under certain wind conditions. See paragraph 101.

**b. VFR approach/departure and transitional surfaces.** Figure 2-7 illustrates the approach/departure and transitional surfaces.

(1) An approach/departure surface is centered on each approach/departure path. The approach/departure path starts at the edge of the FATO and slopes upward at 8:1 (8 units horizontal in 1 unit vertical) for a distance of 4,000 feet (1,219 m) where the width is 500 feet (152 m) at a height of 500 feet (152 m) above the heliport elevation.

(2) The transitional surfaces start from the edges of the FATO parallel to the flight path center line, and from the outer edges of the 8:1 approach/departure surface, and extend outwards at a slope of 2:1 (2 units horizontal in 1 unit vertical) for a distance of 250 feet (76 m) from the centerline. The transitional surface does not apply to the FATO edge opposite the approach/departure surface.

(3) Make sure the approach/departure and transitional surfaces are free of penetrations unless an FAA aeronautical study determines such penetrations not to be hazards. The FAA conducts such aeronautical studies only at public heliports, heliports operated by a federal agency or the Department of Defense, and private airports with FAA-approved approach procedures. Paragraph 111 provides additional information on hazards to air navigation.

(4) At PPR facilities, an alternative to considering transitional surfaces is to increase the size of the 8:1 approach/departure surface for a distance of 2,000 feet (610 m) as shown in Figure 2-9 and Figure 2-11. The lateral extensions on each side of the 8:1 approach/departure surface start at the width of the FATO and are increased so at a distance of 2,000 feet (610 m) from the FATO they are 100 feet (30 m) wide. Make sure obstacles do not penetrate into both Area A and Area B. Make sure obstacles do not penetrate into Area A or Area B unless the FAA determines that the penetration is not a hazard. Mark or light all such penetrations. See paragraph 111 for more information on hazard determinations.

**c. Curved VFR approach/departure paths.** As an option, include one curve in VFR approach/departure paths. As an option, design these paths to use the airspace above public lands, such as freeways or rivers. When including a curved portion in the approach/departure path, make sure the sum of the radius of the arc defining the center line and the length of the straight portion originating at the FATO is not less than 1,886 feet (575 m). Design the approach/departure path so the minimum radius of the curve is 886 feet (270 m) and the curve follows a 1,000 feet (305 m) straight section. Design the approach/departure path so the combined length of the center line of the curved portion and the straight portion is 4,000 feet (1,219 m). See Figure 2-8. Figure 2-10 shows a curved approach/departure path for an 8:1 approach/departure surface.



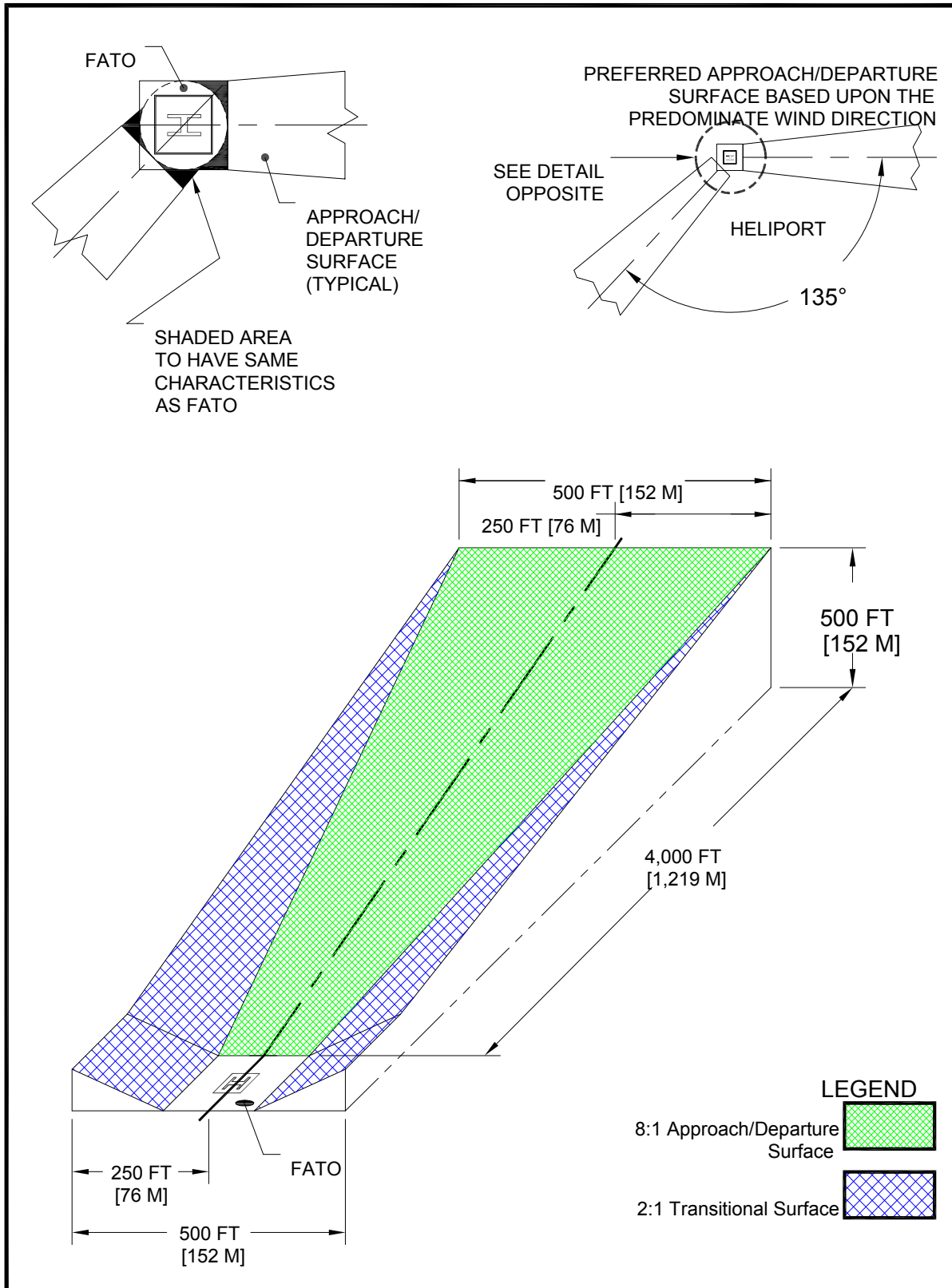
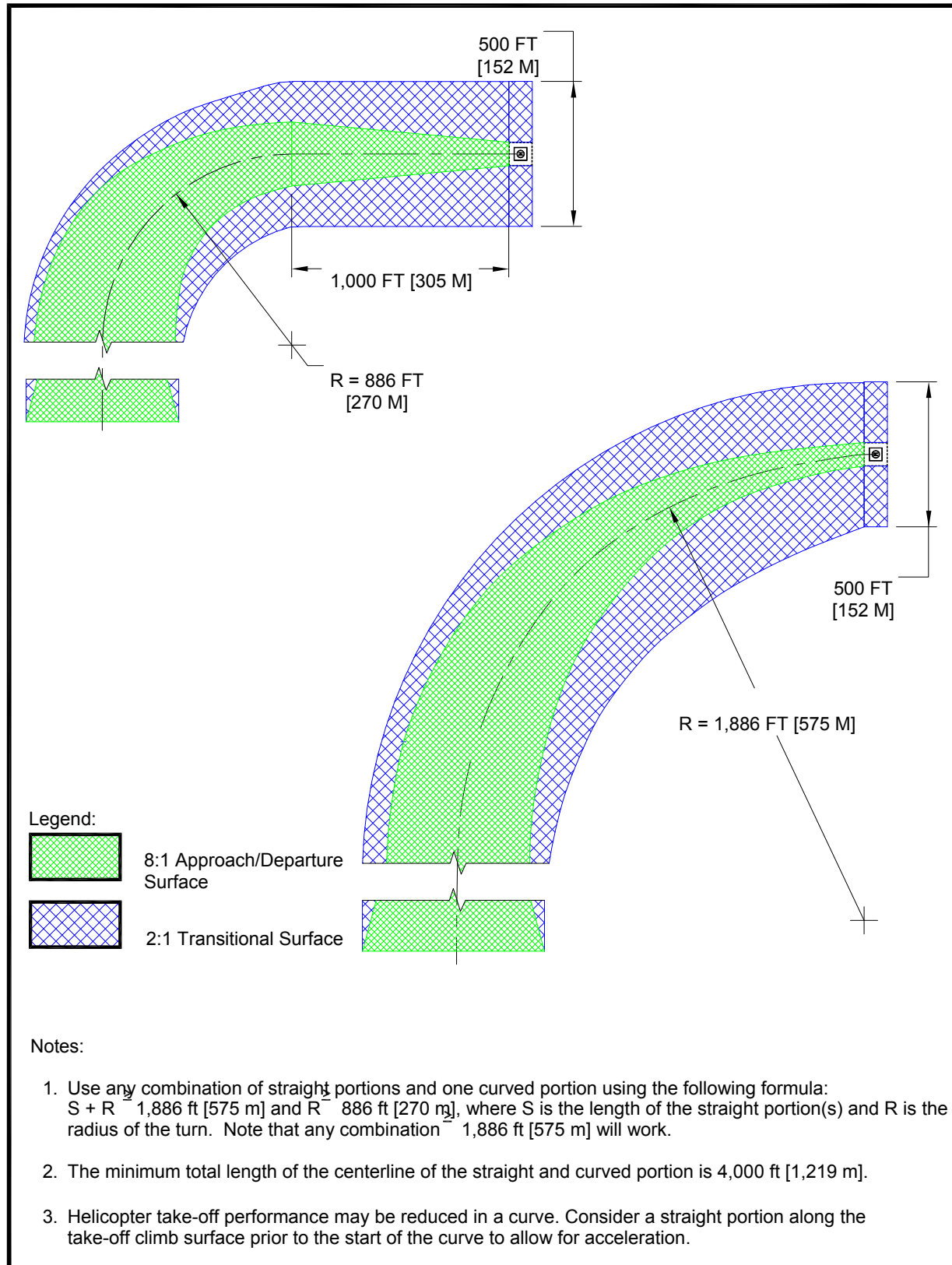
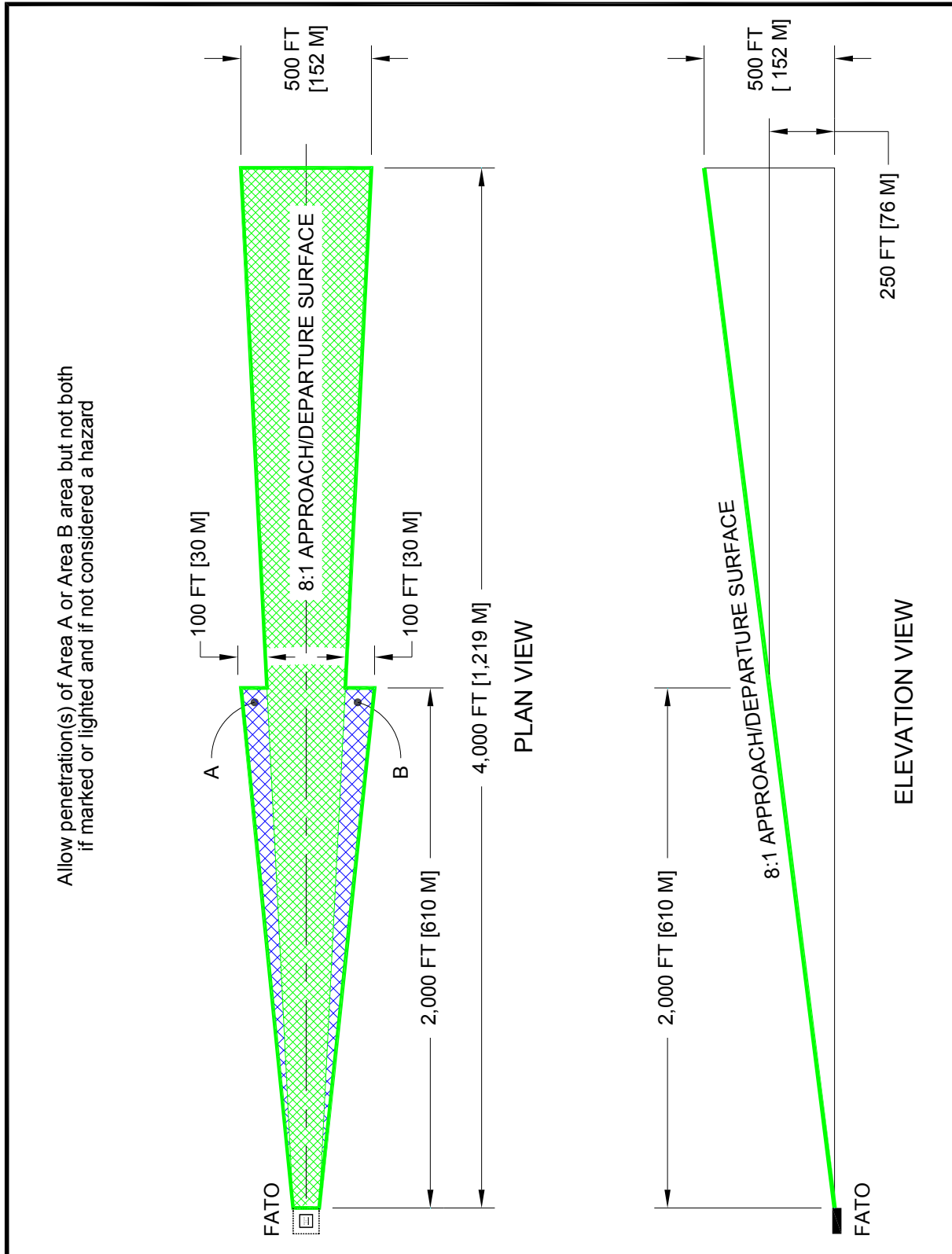


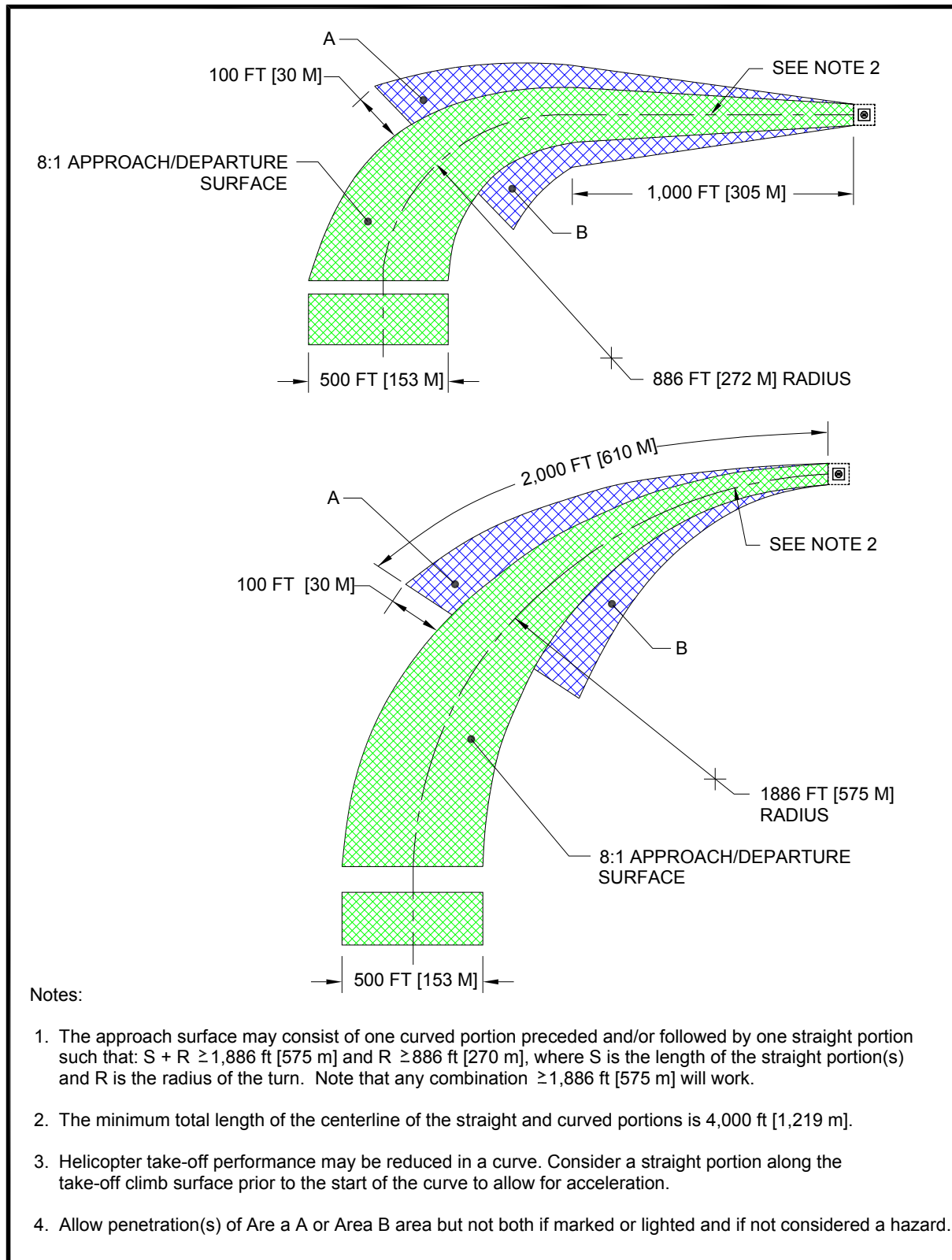
Figure 2-7. VFR Heliport Approach/Departure and Transitional Surfaces: General Aviation



**Figure 2–8. Curved Approach/Departure: General Aviation**



**Figure 2-9. VFR PPR Heliport Lateral Extension of the 8:1 Approach / Departure Surface: General Aviation**



**Figure 2-10. VFR PPR Heliport Lateral Extension of the Curved 8:1 Approach / Departure Surface: General Aviation**

**d. Flight path alignment guidance.** As an option, use flight path alignment markings and/or flight path alignment lights (see paragraphs 215 and 216) where it is desirable and practicable to indicate available approach and/or departure flight path direction(s). See Figure 2–11.

**e. Periodic review of obstructions.** Vigilant heliport operators reexamine obstacles in the vicinity of approach/departure paths on at least an annual basis. This reexamination includes an appraisal of the growth of trees near approach and departure paths. Paragraph 111 provides additional information on hazards to air navigation. Pay particular attention to obstacles that need to be marked or lighted. It may be helpful to maintain a list of the GPS coordinates and the peak elevation of obstacles.

**211. Heliport protection zone (HPZ).** The FAA recommends the establishment of an HPZ for each approach/departure surface. The HPZ is the area under the 8:1 approach/departure surface starting at the FATO perimeter and extending out for a distance of 280 feet (85.3 m), as illustrated in Figure 2–12. The HPZ is intended to enhance the protection of people and property on the ground. This is achieved through heliport owner control over the HPZ. Such control includes clearing HPZ areas (and maintaining them clear) of incompatible objects and activities. The FAA discourages residences and places of public assembly in an HPZ. (Churches, schools, hospitals, office buildings, shopping centers, and other uses with similar concentrations of persons typify places of public assembly.) Do not locate hazardous materials, including fuel, in the HPZ.

**212. Wind cone.**

**a. Specification.** Use a wind cone conforming to AC 150/5345-27, Specification for Wind Cone Assemblies, to show the direction and magnitude of the wind. Use a color that provides the best possible color contrast to its background.

**b. Wind cone location.** Locate the wind cone so it provides the pilot with valid wind direction and speed information in the vicinity of the heliport under all wind conditions.

(1) At many landing sites, there may be no single, ideal location for the wind cone. At other sites, it may not be possible to site a wind cone at the ideal location. In such cases, install more than one wind cone in order to provide the pilot with all the wind information needed for safe operations.

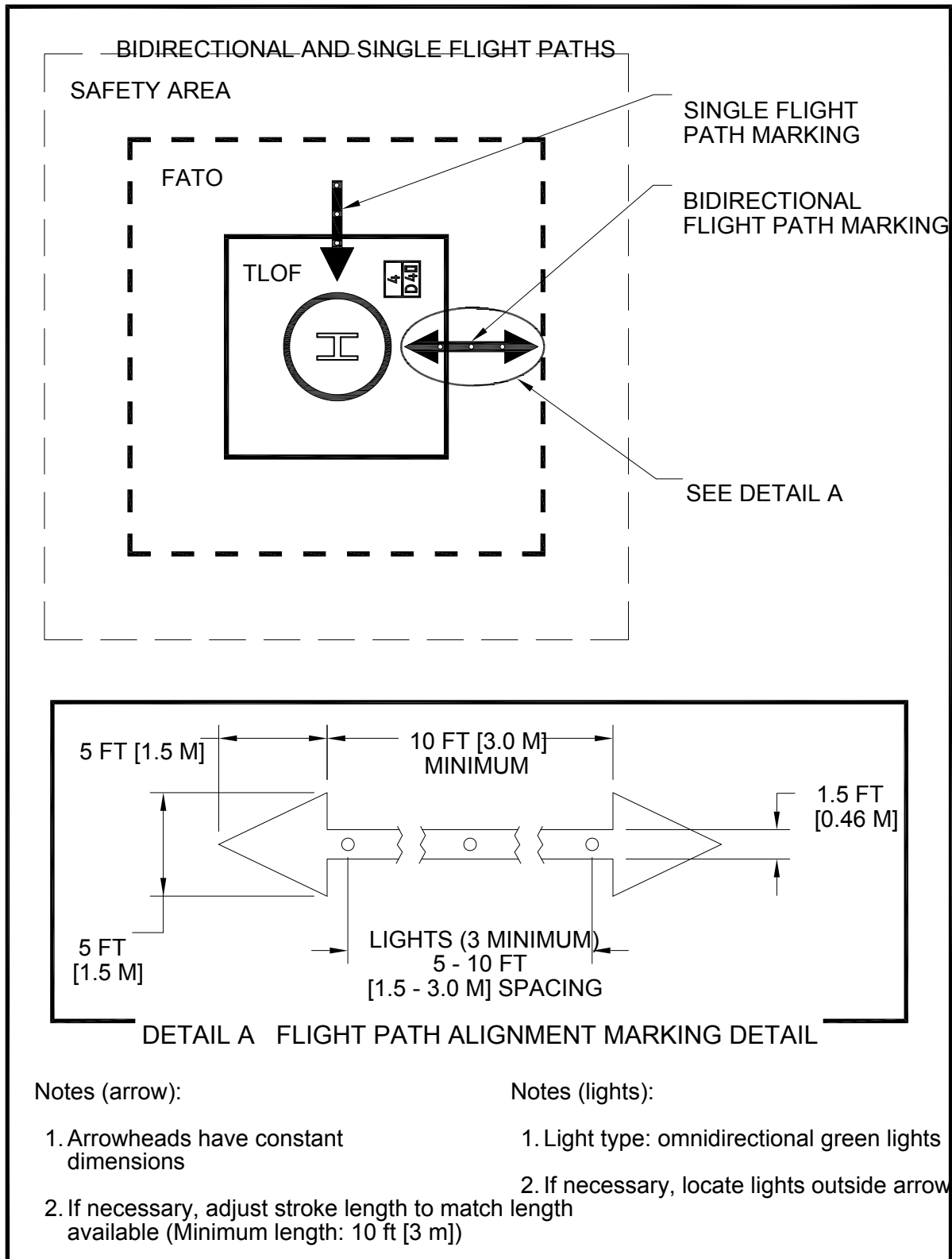
(2) Place the wind cone so a pilot on the approach path can see it clearly when the helicopter is 500 feet (150 m) from the TLOF.

(3) Place the wind cone so pilots can see it from the TLOF.

(4) To avoid presenting an obstruction hazard, locate the wind cone(s) outside the safety area, and so it does not penetrate the approach/departure or transitional surfaces.

**c. Wind cone lighting.** At a heliport intended for night operations, illuminate the wind cone, either internally or externally, to ensure it is clearly visible.

**213. Taxiways and taxi routes.** Taxiways and taxi routes provide for the movement of helicopters from one part of a landing facility to another. They provide a connecting path between the FATO and a parking area. They also provide a maneuvering aisle within the parking area. A taxi route includes the taxiway plus the appropriate clearances needed on both sides. The relationship between a taxiway and a taxi route is illustrated in Figure 2–13, Figure 2–14, and Figure 2–15. At heliports with no parking or refueling area outside the TLOF(s), it is not necessary to provide a taxi route or taxiway.



**Figure 2-11. Flight Path Alignment Marking and Lights: General Aviation**

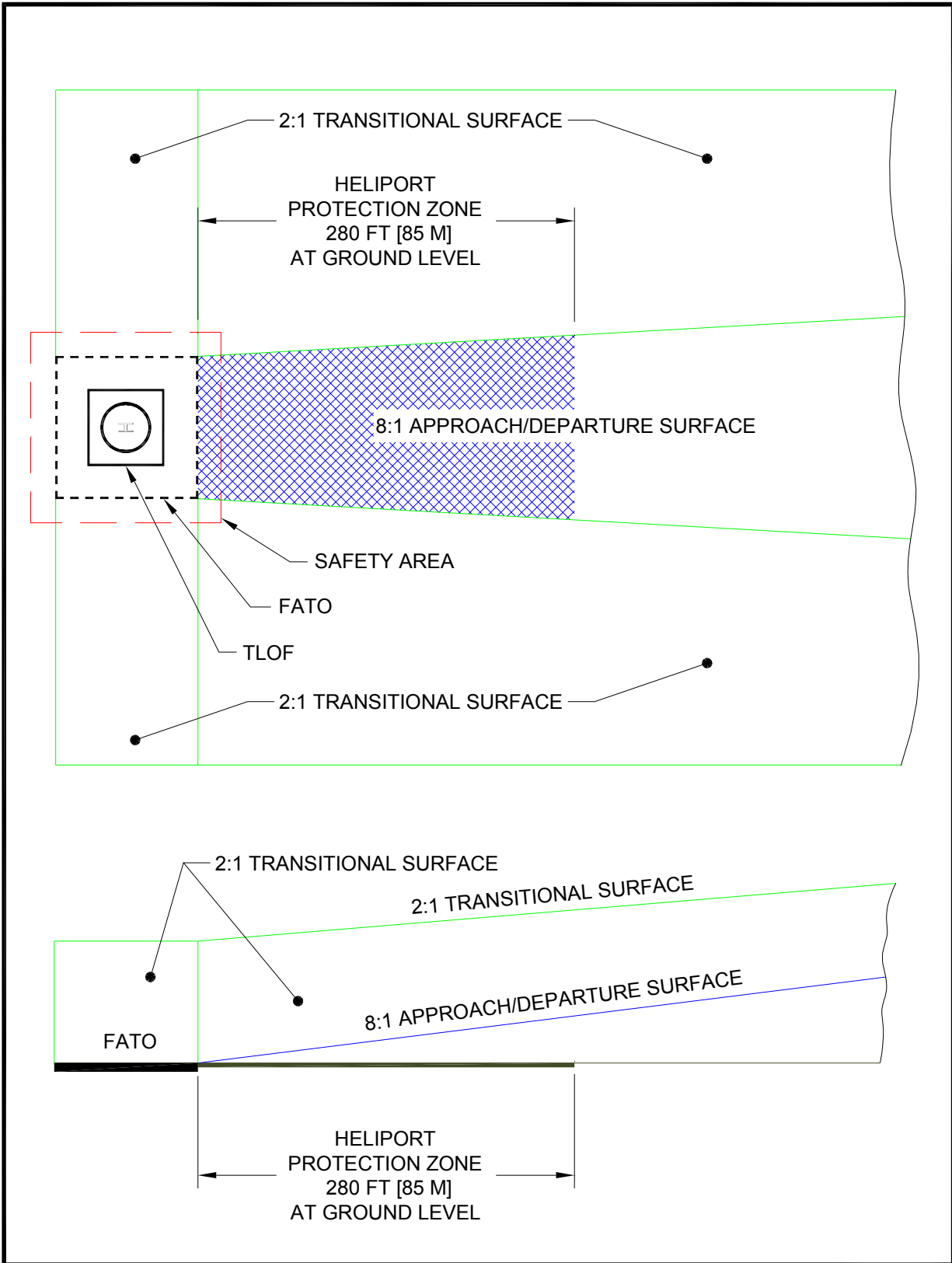


Figure 2-12. Heliport Protection Zone: General Aviation

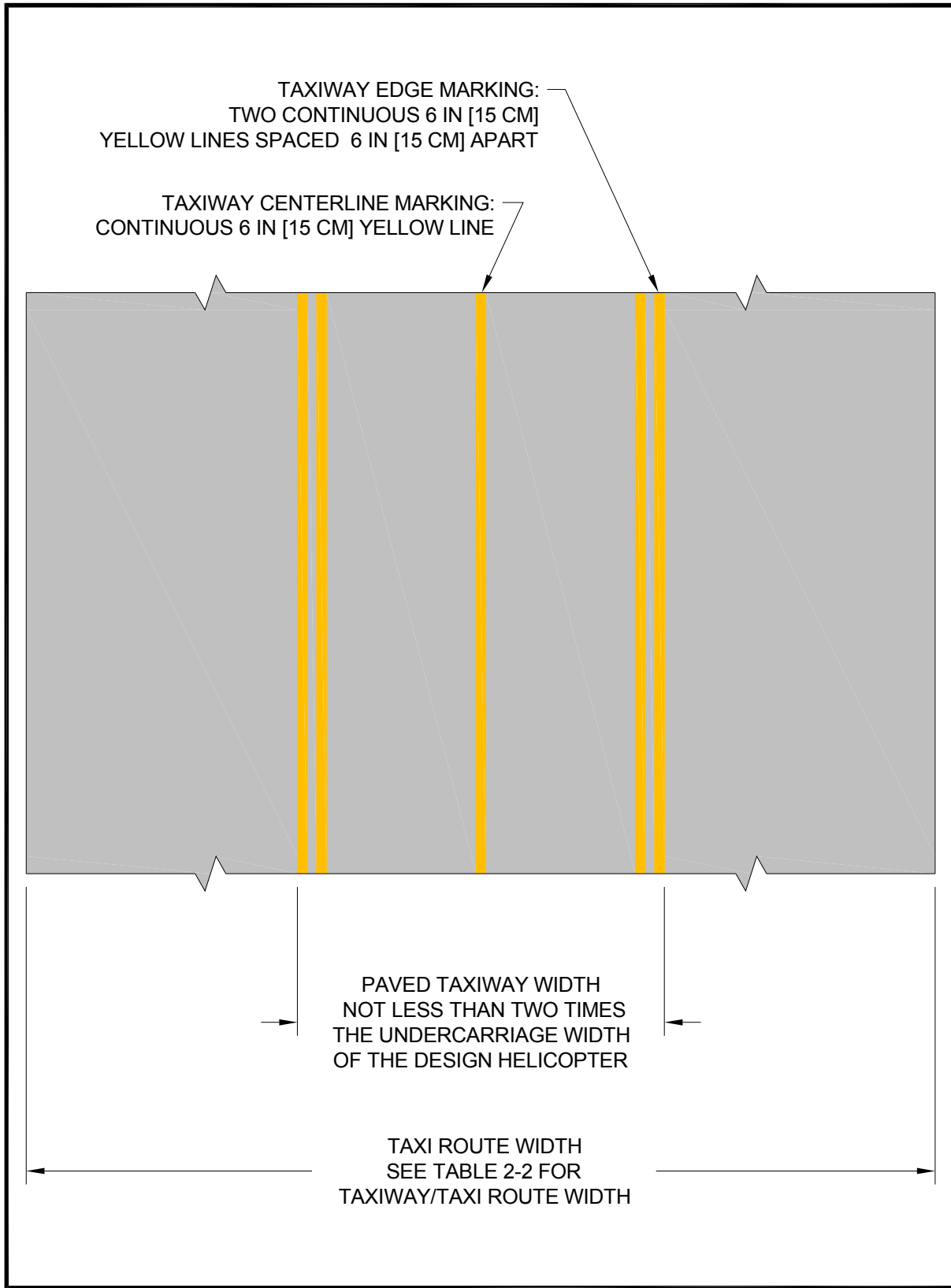
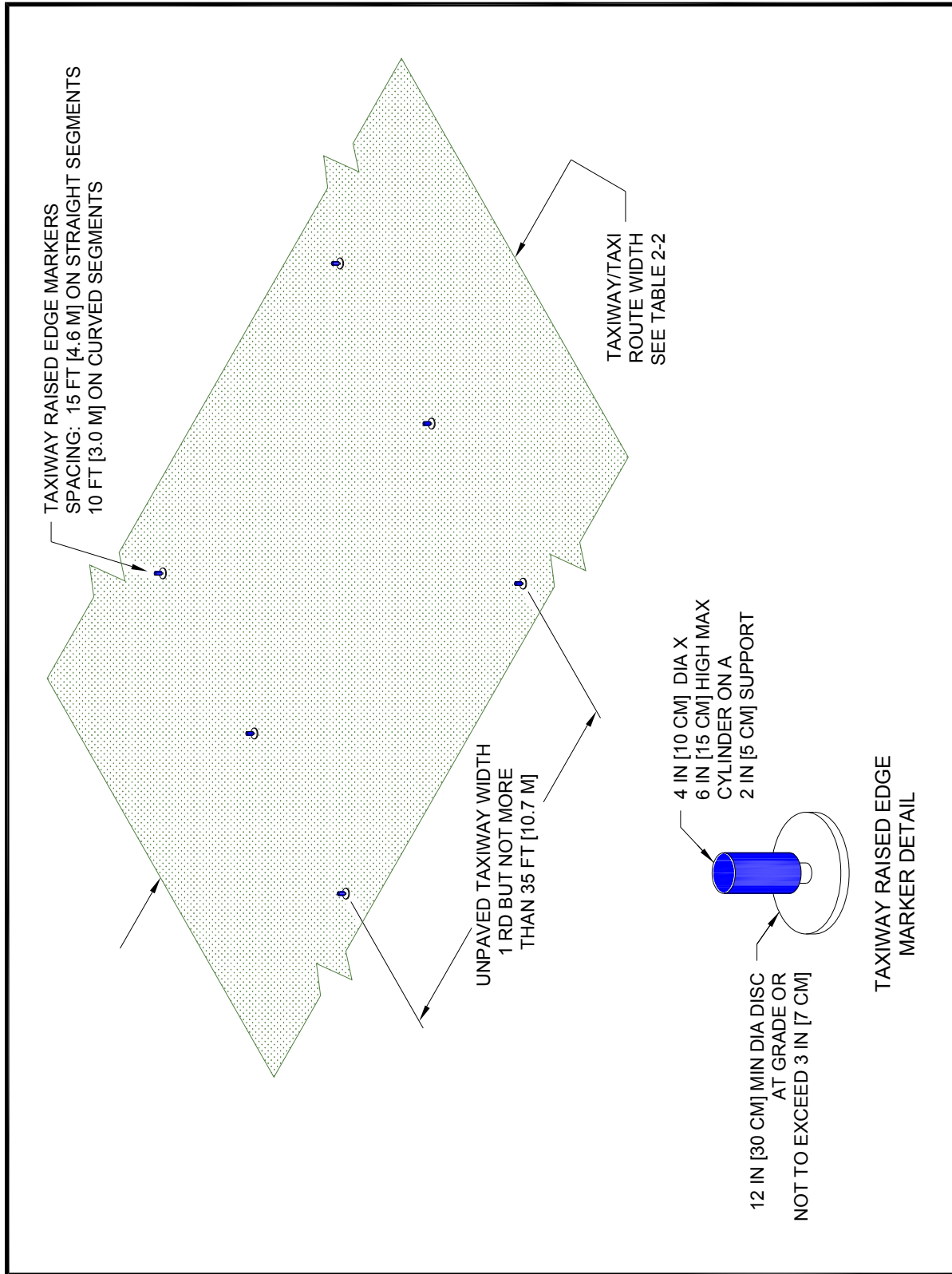
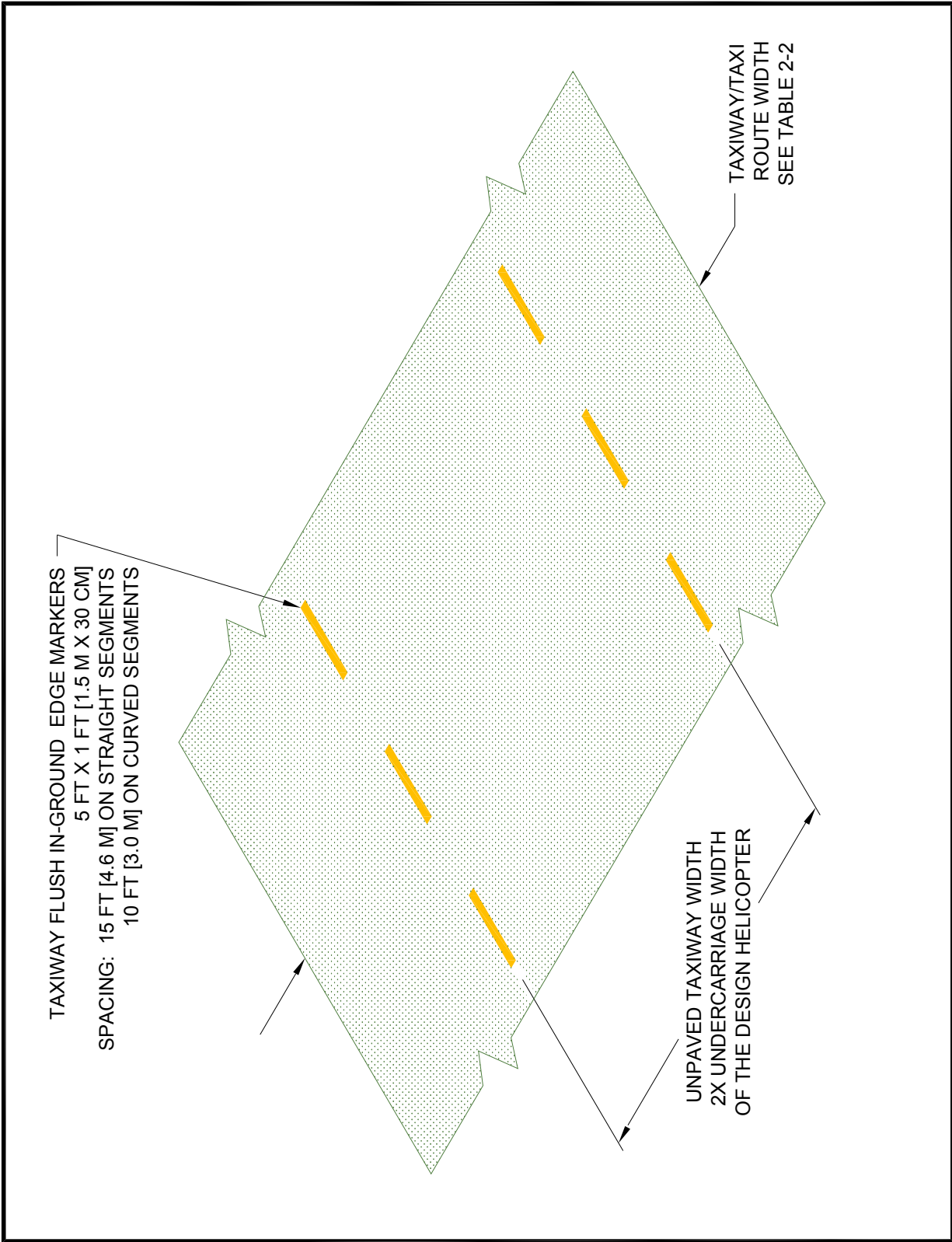


Figure 2-13. Taxiway/Taxi Route Relationship – Paved Taxiway: General Aviation





**Figure 2-14. Taxiway/Taxi Route Relationship – Unpaved Taxiway with Raised Edge Markers: General Aviation**



**Figure 2-15. Taxiway/Taxi Route Relationship –  
Unpaved Taxiway with Flush Edge Markers: General Aviation**

**a. Taxiway/taxi route widths.** The dimensions of taxiways and taxi routes are a function of helicopter size, taxiway/taxi route marking, and type of taxi operations (ground taxi versus hover taxi). These dimensions are defined in Table 2-2. Normally, the requirement for hover taxi dictates the taxiway/taxi route widths. However, when the fleet comprises a combination of large ground taxiing helicopters and smaller air taxiing helicopters, the larger aircraft may dictate the taxiway/taxi route widths. If wheel-equipped helicopters taxi with wheels not touching the surface, design the facility with hover taxiway widths rather than ground taxiway widths. Where the visibility of the centerline marking cannot be guaranteed at all times, such as locations where snow or dust commonly obscure the centerline marking and it is not practical to remove it, determine the minimum taxiway/taxi route dimensions as if there was no centerline marking.

**b. Surfaces.** For ground taxiways, provide a portland cement concrete, asphalt, or stabilized surfaces, such as turf, in accordance with the standards of items P-217 of AC 150/5370-10. For unpaved portions of taxiways and taxi routes, provide a turf cover or treat the surface in some way to prevent dirt and debris from being raised by a taxiing helicopter's rotor wash.

**c. Gradients.** Taxiway and taxi route gradient standards are defined in Chapter 7.

**214. Helicopter parking.** If more than one helicopter at a time is expected at a heliport, design the facility with an area designated for parking helicopters. The size of this area depends on the number and size of specific helicopters to be accommodated. It is not necessary that every parking position accommodate the design helicopter. Construct individual parking positions to accommodate the helicopter size and weights expected to use the parking position at the facility. However, use the design helicopter to determine the separation between parking positions and taxi routes. Use the larger helicopter to determine the separation between parking positions intended for helicopters of different sizes. Build the parking positions to support the static loads of the helicopter intended to use the parking area. Design parking areas as one large, paved, apron or as individual, paved, parking positions. Ground taxi turns of wheeled helicopters are significantly larger than a hover turn. Consider the turn radius of helicopters when designing taxi intersections and parking positions for wheeled helicopters. Design heliport parking areas so helicopters will be parked in an orientation that keeps the "avoid areas" around the tail rotors clear of passenger walkways. See Figure 2-16, Figure 2-17, and Figure 2-19.

**a. Location.** Do not locate aircraft parking areas under an approach/departure surface. However, as an option, allow aircraft parking areas under the transitional surfaces.

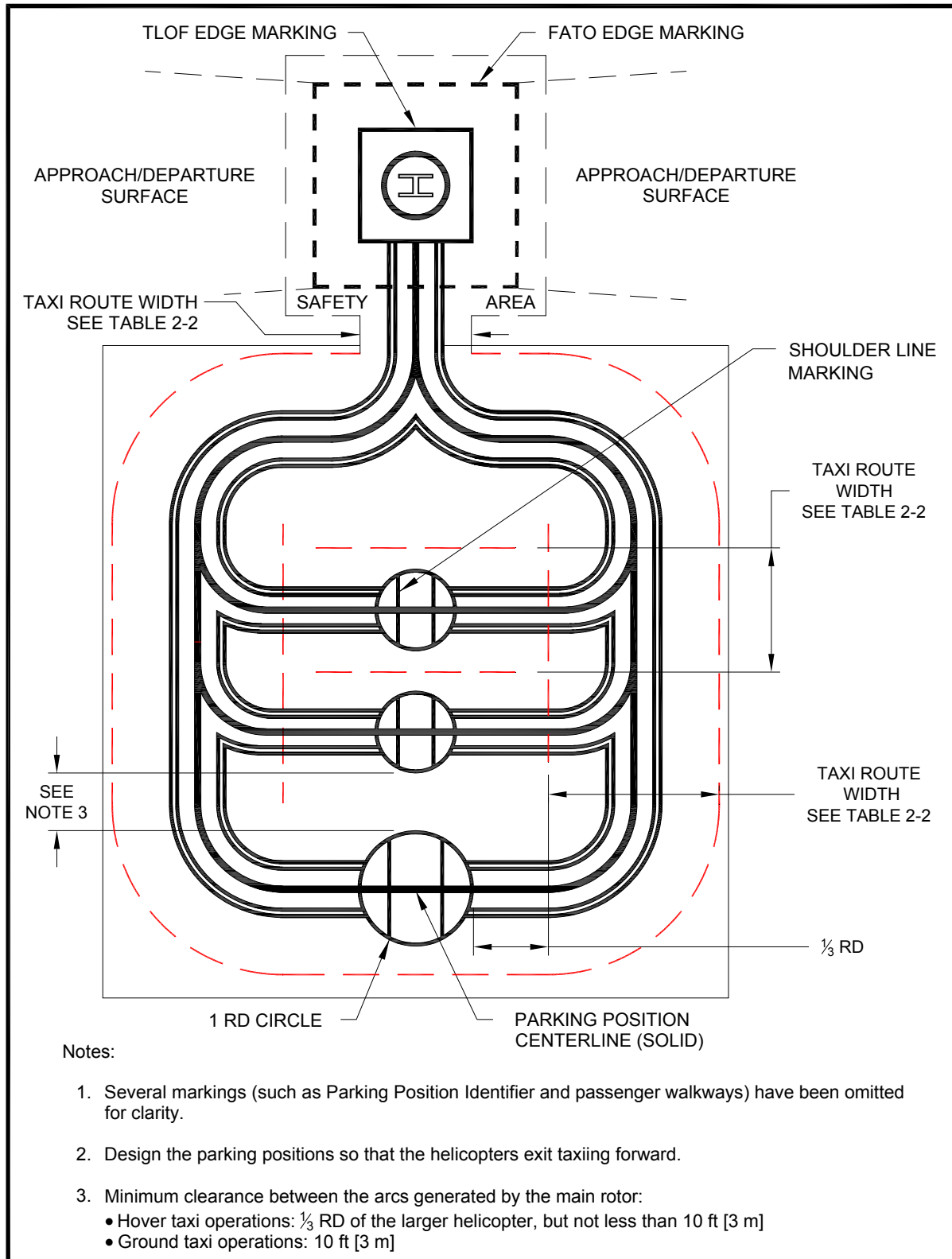
(1) For "turn around" parking positions, locate the parking position to provide a minimum distance between the tail rotor circle and any object, building, safety area, or other parking position. The minimum distance is 10 feet (3 m) for ground taxi operations and the greater of 10 feet (3 m) or  $\frac{1}{3}$  RD for hover taxi operations. See Figure 2-19.

(2) For "taxi-through" and "back-out" parking positions, locate the parking position to provide a minimum distance between the main rotor circle and any object, building, safety area, or other parking position. The minimum distance is 10 feet (3 m) for ground taxi operations and the greater of 10 feet (3 m) or  $\frac{1}{3}$  RD for hover taxi operations. See Figure 2-20.

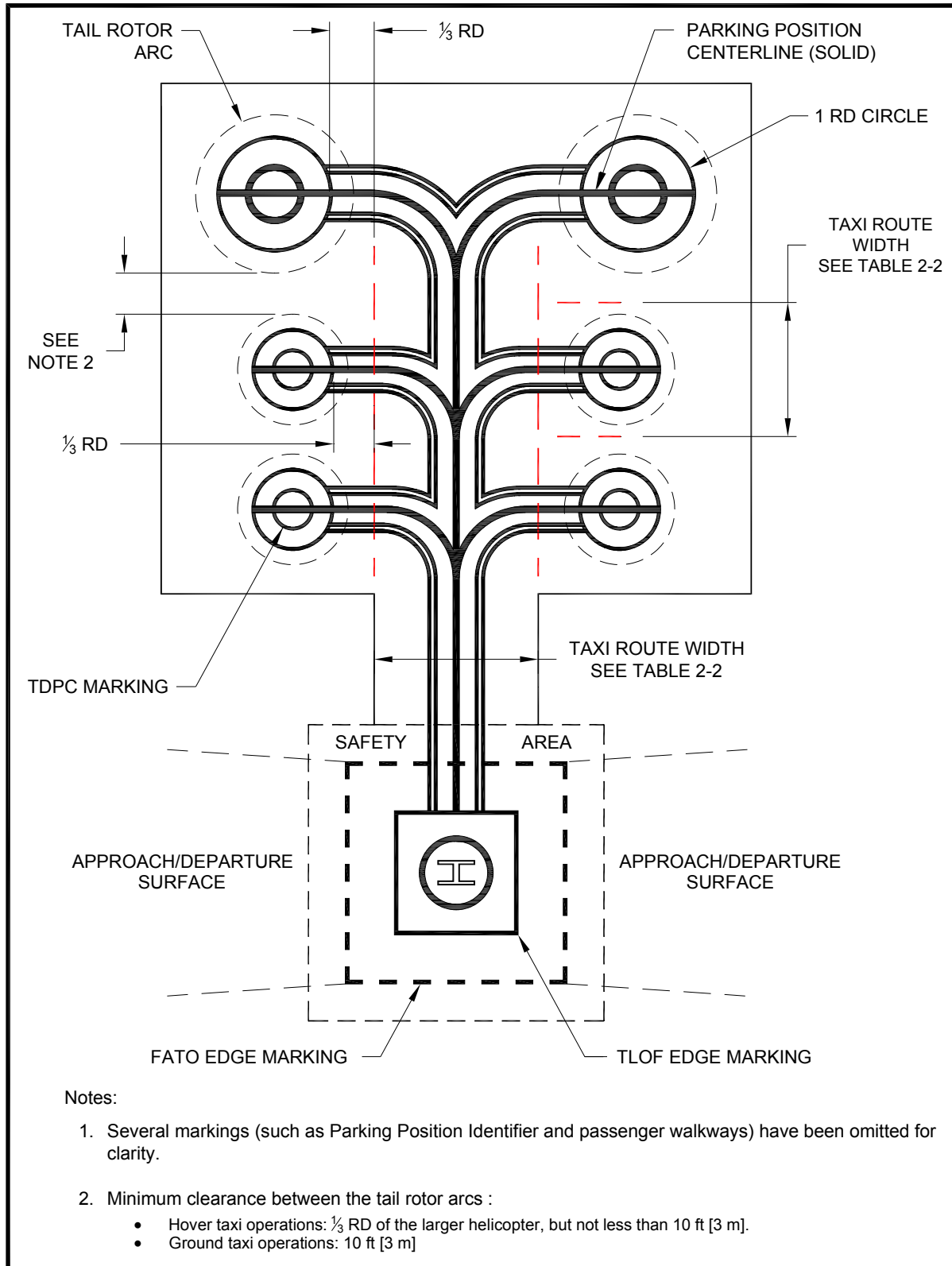
(3) Locate the parking position to provide a minimum distance between the main rotor circle and the edge of any taxi route. Design parking positions such that the helicopter taxis through, turns around, or backs out to depart. The minimum distance is  $\frac{1}{3}$  RD for "turn around" and "taxi through" parking areas, and  $\frac{1}{2}$  RD for "back-out" parking areas. See Figure 2-16, Figure 2-17, and Figure 2-18.

**Table 2-2. Taxiway/Taxi Route Dimensions – General Aviation Heliports**

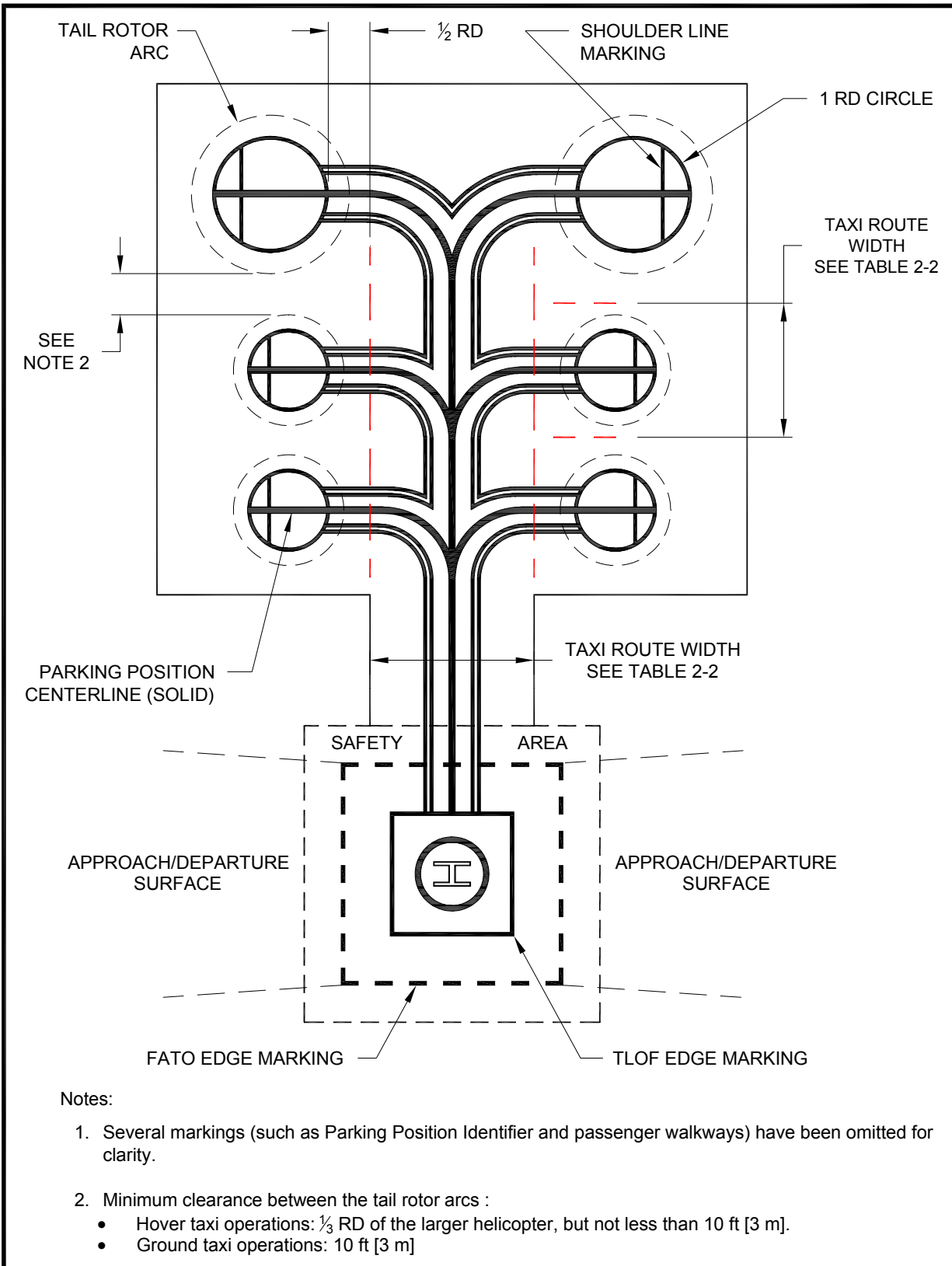
<b>Taxiway (TW) Type</b>	<b>Minimum Width of Paved Area</b>	<b>Centerline Marking Type</b>	<b>TW Edge Marking Type</b>	<b>Lateral Separation Between TW Edge Markings</b>	<b>Total Taxi Route Width</b>
Ground Taxiway	2 x UC	Painted	Painted	2 x UC	1 ½ RD
			Elevated	1 RD but not greater than 35 ft (10.7 m)	
	Unpaved but stabilized for ground taxi	None	Flush	2 x UC	
			Elevated	1 RD but not greater than 35 ft (10.7 m)	
Hover Taxiway	2 x UC	Painted	Painted	2 x UC	2 RD
	Unpaved	None	Elevated or Flush	1 RD but not greater than 35 ft (10.7 m)	
RD: rotor diameter of the design helicopter TW: taxiway UC: undercarriage length or width (whichever is greater) of the design helicopter					



**Figure 2–16. Parking Area Design – “Taxi-through” Parking Positions: General Aviation**



**Figure 2-17. Parking Area Design – “Turn-around” Parking Positions: General Aviation**



**Figure 2-18. Parking Area Design – “Back-out” Parking Positions: General Aviation**

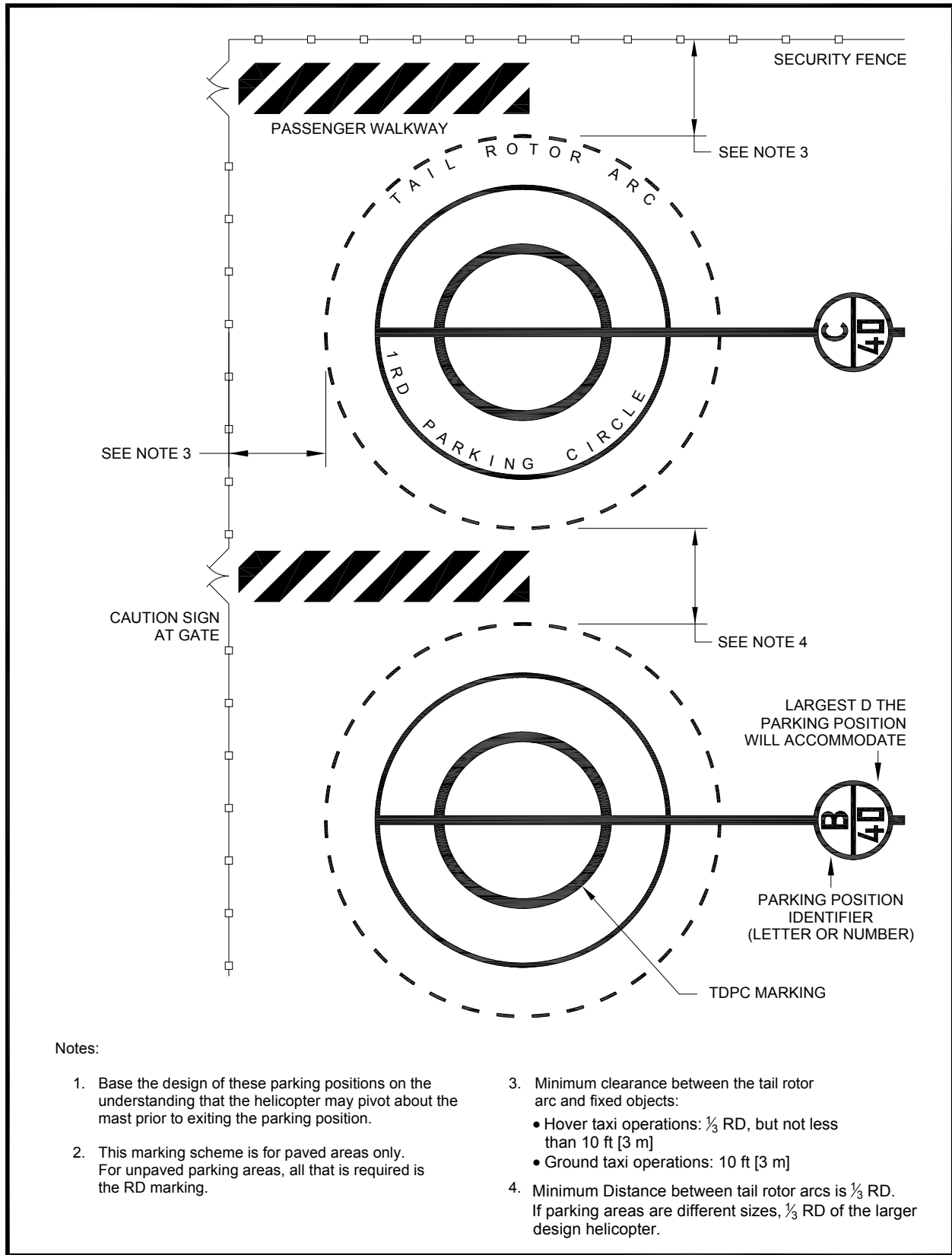
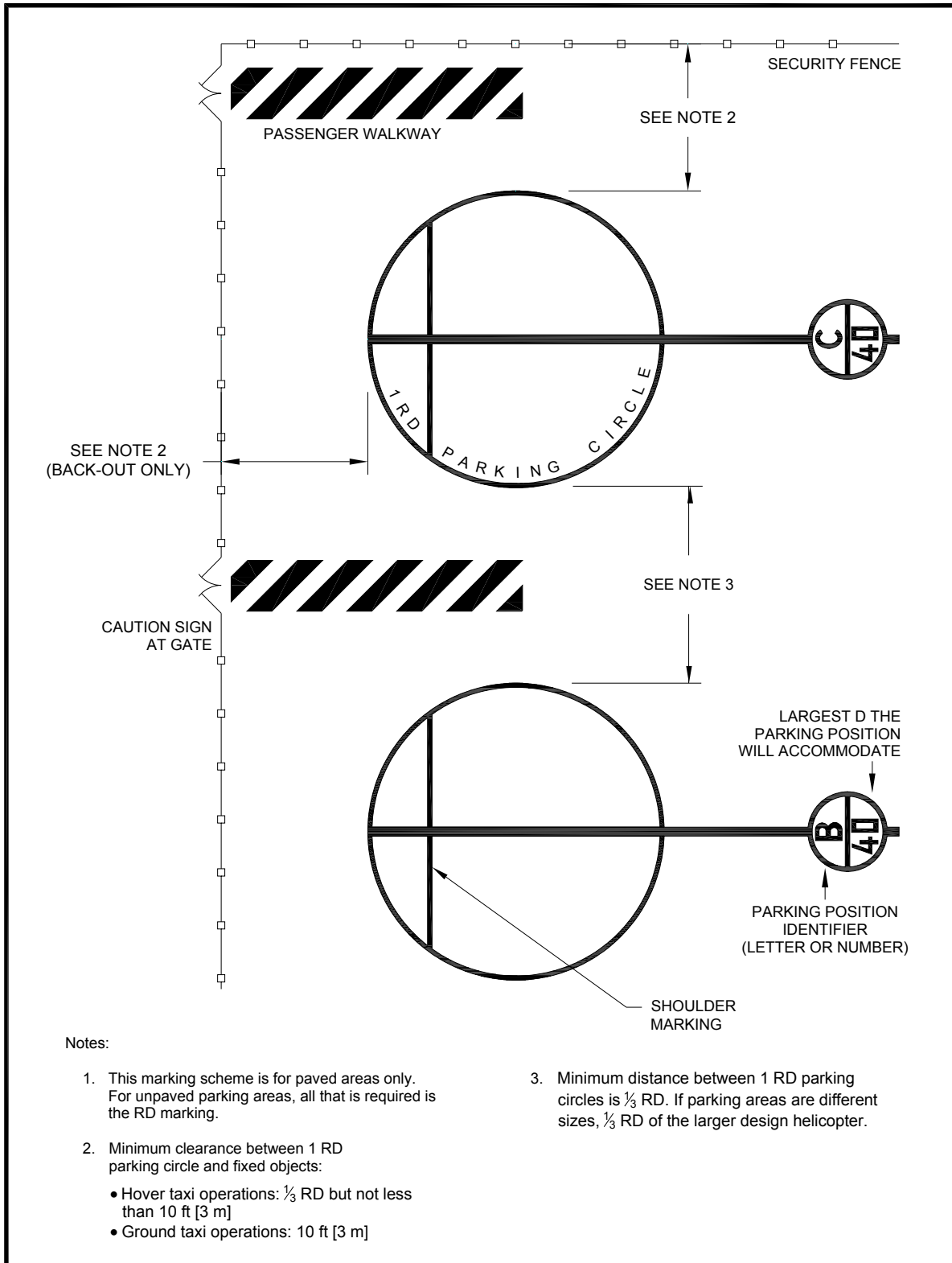


Figure 2-19. "Turn-around" Parking Position Marking: General Aviation





**Figure 2–20. “Taxi-through” and “Back-out” Parking Position Marking: General Aviation**

**b. Size.** Parking position sizes are dependent upon the helicopter size. The clearance between parking positions are dependent upon the type of taxi operations (ground taxi or hover taxi) and the intended paths for maneuvering in and out of the parking position. The more demanding requirement will dictate what is required at a particular site. Usually, the parking area requirements for skid-equipped helicopters will be the most demanding. However, when the largest helicopter is a very large, wheeled aircraft (for example, the S-61), and the skid-equipped helicopters are all much smaller, the parking requirements for wheeled helicopters may be the most demanding. If wheel-equipped helicopters taxi with wheels not touching the surface, design parking areas based on hover taxi operations rather than ground taxi operations.

(1) If all parking positions are the same size, design them to accommodate the largest helicopter that will park at the heliport.

(2) When there is more than one parking position, as an option design the facility with parking positions of various sizes with at least one position that will accommodate the largest helicopter that will park at the heliport. Design other parking positions to be smaller, for the size of the individual or range of individual helicopters parking at that position. Figure 2–21 provides guidance on parking position identification, size, and weight limitations.

(3) “Taxi-through” parking positions are illustrated in Figure 2–16. When using this design for parking positions, the heliport owner and operator take steps to ensure all pilots are informed that “turn-around” or “back-up” departures from the parking position are not permitted.

(4) “Turn-around” parking positions are illustrated in Figure 2–17.

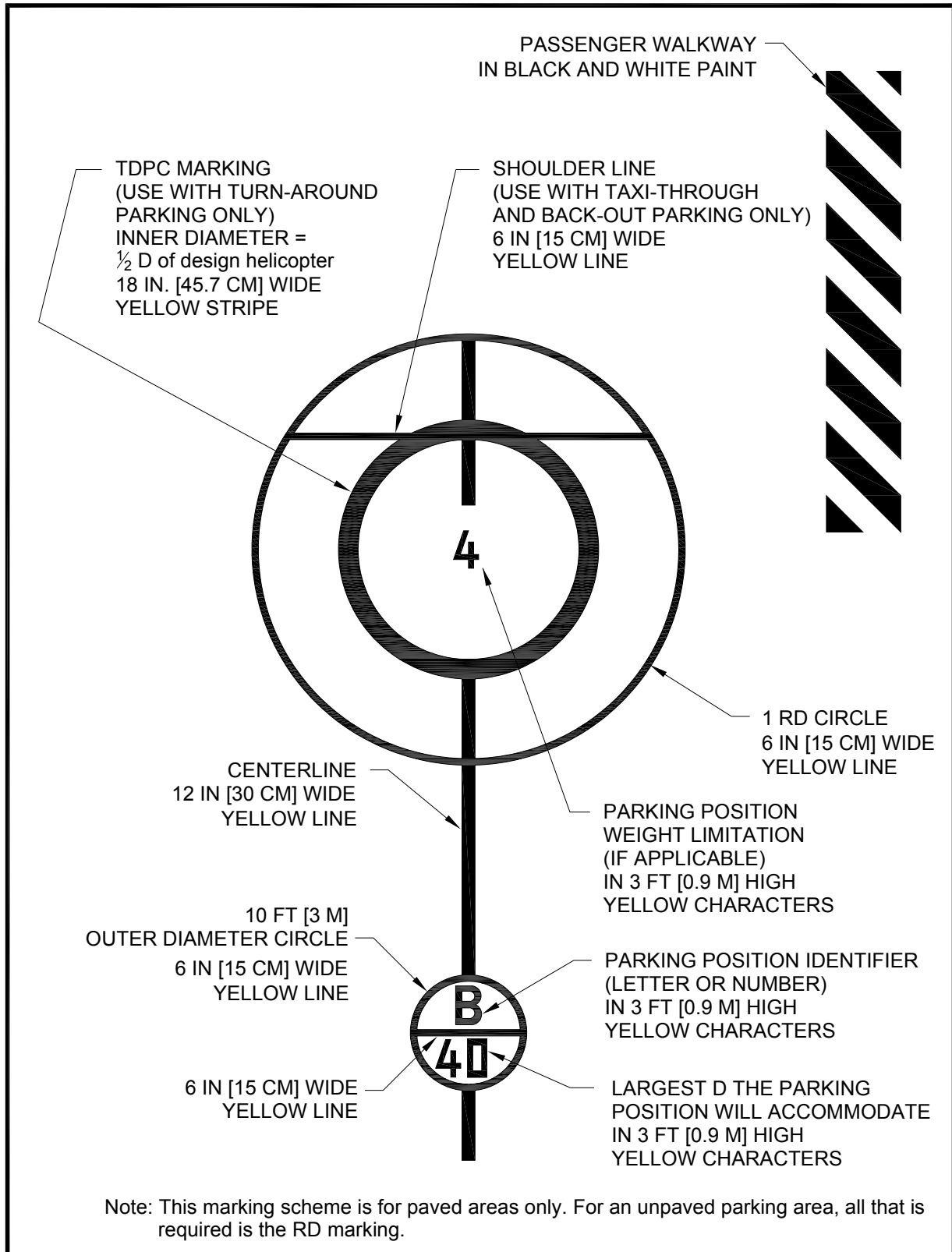
(5) “Back-out” parking positions are illustrated in Figure 2–18. When using this design for parking positions, design the adjacent taxiway to accommodate hover taxi operations so the width of the taxiway will be adequate to support “back-out” operations.

**c. Parking pads.** When partially paving a parking area, design the smallest dimension of the paved parking pad to be a minimum of two times the maximum dimension (length or width, whichever is greater) of the undercarriage or the RD, whichever is less, of the largest helicopter that will use the parking position. Place the parking pad in the center of the parking position circle.

**d. Walkways.** At parking positions, provide marked walkways where practicable. Design the pavement to drain away from walkways.

**e. Fueling.** Design the facility to allow fueling with the use of a fuel truck or a specific fueling area with stationary fuel tanks.

(1) Various federal, state, and local requirements for petroleum handling facilities apply to systems for storing and dispensing fuel. Guidance is found in AC 150/5230-4, Aircraft Fuel Storage, Handling, and Dispensing on Airports. Additional information may be found in various National Fire Protection Association (NFPA) publications. For more reference material, see Appendix D.



**Figure 2–21. Parking Position Identification, Size, and Weight Limitations: General Aviation**

(2) Do not locate fueling equipment in the TLOF, FATO, or safety area. Design and mark separate fueling locations to minimize the potential for helicopters to collide with the dispensing equipment. Design fueling areas so there is no object tall enough to be hit by the main or tail rotor blades within a distance of RD from the center point of the position where the helicopter would be fueled (providing  $\frac{1}{2}$  RD clearance from the rotor tips). If this is not practical at an existing facility, install long fuel hoses.

(3) **Lighting.** Light the fueling area if night fueling operations are contemplated. Ensure any light poles do not constitute an obstruction hazard.

f. **Tiedowns.** Install recessed tiedowns to accommodate extended or overnight parking of based or transient helicopters. Recess any tiedowns so they will not be a hazard to helicopters. Ensure any depression associated with the tiedowns is of a diameter not greater than  $\frac{1}{2}$  the width of the smallest helicopter landing wheel or landing skid anticipated to be operated on the heliport surface. In addition, provide storage for tiedown chocks, chains, cables and ropes off the heliport surface to avoid fouling landing gear. Find guidance on recessed tiedowns in AC 20-35, Tiedown Sense.

**215. Heliport markers and markings.** Markers and/or surface markings identify the facility as a heliport. Use paint or preformed materials for surface markings. (See AC 150/5370-10, Item P-620, for specifications for paint and preformed material.) As options, use reflective paint and reflective markers, though overuse of reflective material can be blinding to a pilot using landing lights. As an option, outline lines/markings with a 6-inch (15 cm) wide line of a contrasting color to enhance conspicuity. Place markings that define the edges of a TLOF, FATO, taxiway or apron within the limits of those areas. Use the following markers and markings.

a. **Heliport identification marking.** The identification marking identifies the location as a heliport, marks the TLOF and provides visual cues to the pilot.

(1) **Standard heliport identification symbol.** Mark the TLOF with a white “H” marking. The “H” has a minimum height of the lesser of 0.3 D or 10 feet (3 m). Locate the “H” in the center of the TLOF and orient it on the axis of the preferred approach/departure path. Place a one-foot wide bar under the “H” when it is necessary to distinguish the preferred approach/departure direction. The proportions and layout of the letter “H” are illustrated in Figure 2–23. For a height of “H” less than 10 feet (3 m), reduce other dimensions proportionately.

(2) **Nonstandard heliport identification marking.** As an option use a distinctive marking, such as a company logo, to identify the facility as a PPR heliport. However, a nonstandard marking does not necessarily provide the pilot with the same degree of visual cueing as the standard heliport identification symbol. To compensate, increase the size of the safety area when the standard heliport identification symbol “H” is not used. See Table 2-1.

b. **TLOF markings.**

(1) **TLOF perimeter marking.** Define the TLOF perimeter with markers and/or lines. If the heliport operator does not mark the TLOF, increase the size of the safety area as described in paragraph 209.a and Table 2-1.

(a) **Paved TLOFs.** Define the perimeter of a paved or hard surfaced TLOF with a continuous, 12-inch-wide (30 cm), white line. See Figure 2–25.

(b) **Unpaved TLOFs.** Define the perimeter of an unpaved TLOF with a series of 12-inch-wide (30 cm), flush, in-ground markers, each approximately 5 feet (1.5 m) in length with end-to-end spacing of not more than 6 inches (15 cm). See Figure 2–25.

(2) **Touchdown/positioning circle (TDPC) marking.** A TDPC marking provides guidance to allow a pilot to touch down in a specific position on paved surfaces. When the pilot’s seat is over the

marking, the undercarriage will be inside the LBA, and all parts of the helicopter will be clear of any obstacle by a safe margin. A TDPC marking is a yellow circle with an inner diameter of  $\frac{1}{2}$  D and a line width of 18 in (46 m). Locate a TDPC marking in the center of a TLOF. (See Figure 2–23). As an option, at PPR heliports where the TLOF width is less than 16 feet (5 m), omit the TDPC marking.

**(3) TLOF size and weight limitations.** Mark the TLOF to indicate the length and weight of the largest helicopter it will accommodate, as shown in Figure 2–23. Place these markings in a box in the lower right-hand corner of a rectangular TLOF, or on the right-hand side of the “H” of a circular TLOF, when viewed from the preferred approach direction. The box is 5 feet (1.5 m) square. The numbers are 18 inches (46 cm) high. (See Figure C–1). If necessary, allow this marking to interrupt the TDPC marking. (See Figure 2–23 and Figure C–1.) The numbers are black with a white background. This marking is optional at a TLOF with a turf surface. This marking is also optional at PPR heliports, since the operator ensures all pilots using the facility are thoroughly knowledgeable with this and any other facility limitations.

**(a) TLOF size limitation.** This number is the length (D) of the largest helicopter the TLOF will accommodate, as shown in Figure 2–23. The marking consists of the letter “D” followed by the dimension in feet. Do not use metric equivalents for this purpose. Center this marking in the lower section of the TLOF size/weight limitation box.

**(b) TLOF weight limitations.** If a TLOF has limited weight-carrying capability, mark it with the maximum takeoff weight of the design helicopter, in units of thousands of pounds, as shown in Figure 2–23. Do not use metric equivalents for this purpose. Center this marking in the upper section of a TLOF size/weight limitation box. If the TLOF does not have a weight limit, add a diagonal line, extending from the lower left hand corner to the upper right hand corner, to the upper section of the TLOF size/weight limitation box. See Figure 2–23.

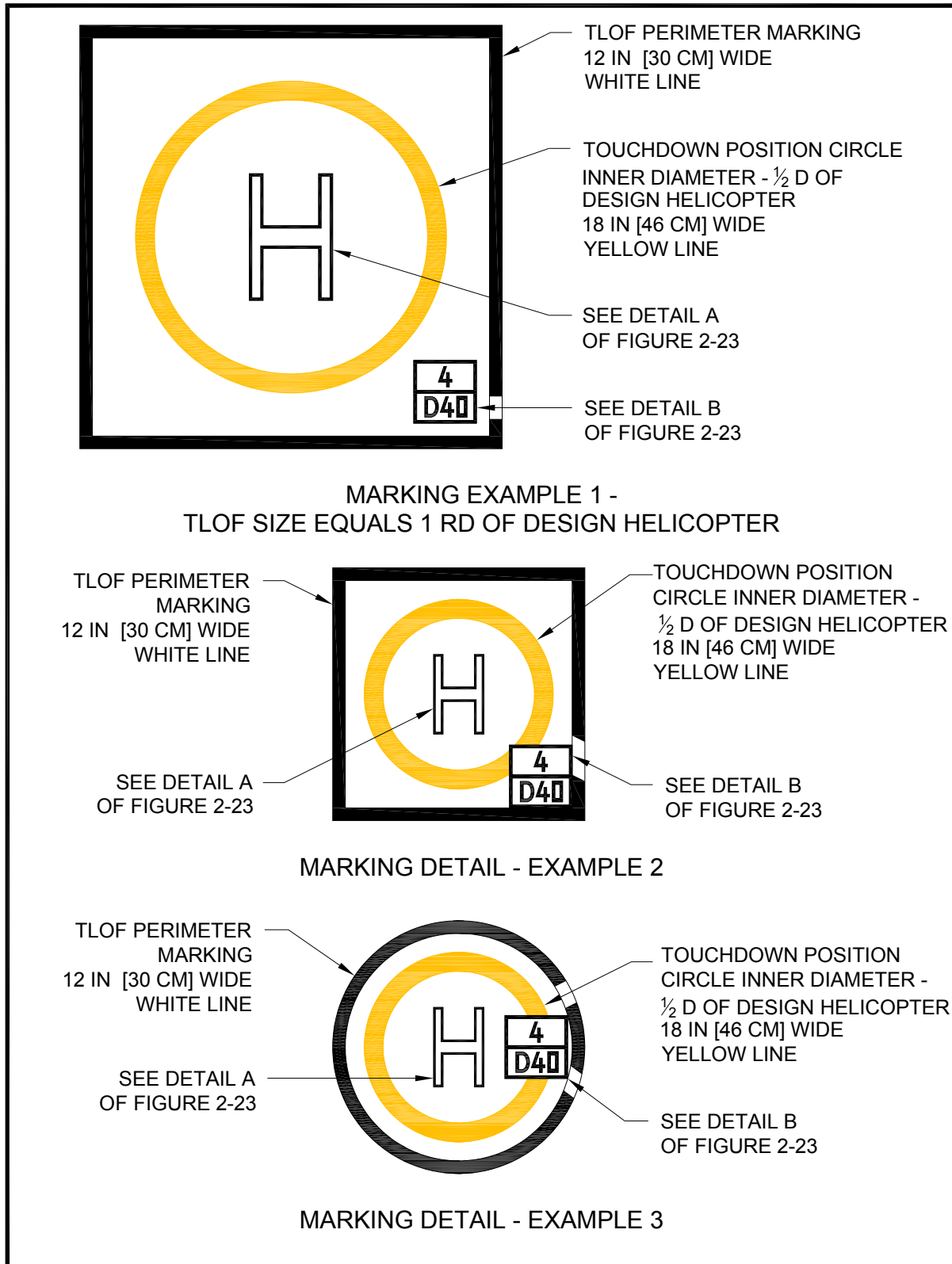
**c. Extended pavement/structure markings.** As an option, increase the pavement or structure without a corresponding increase in the length and width or diameter of the FATO to accommodate pedestrians and/or support operations. Whether or not this increased area is part of the LBA, mark the area outside the TLOF with 12-inch-wide (30 cm) diagonal black and white stripes. See Figure 2–24 for marking details.

**d. FATO markings.**

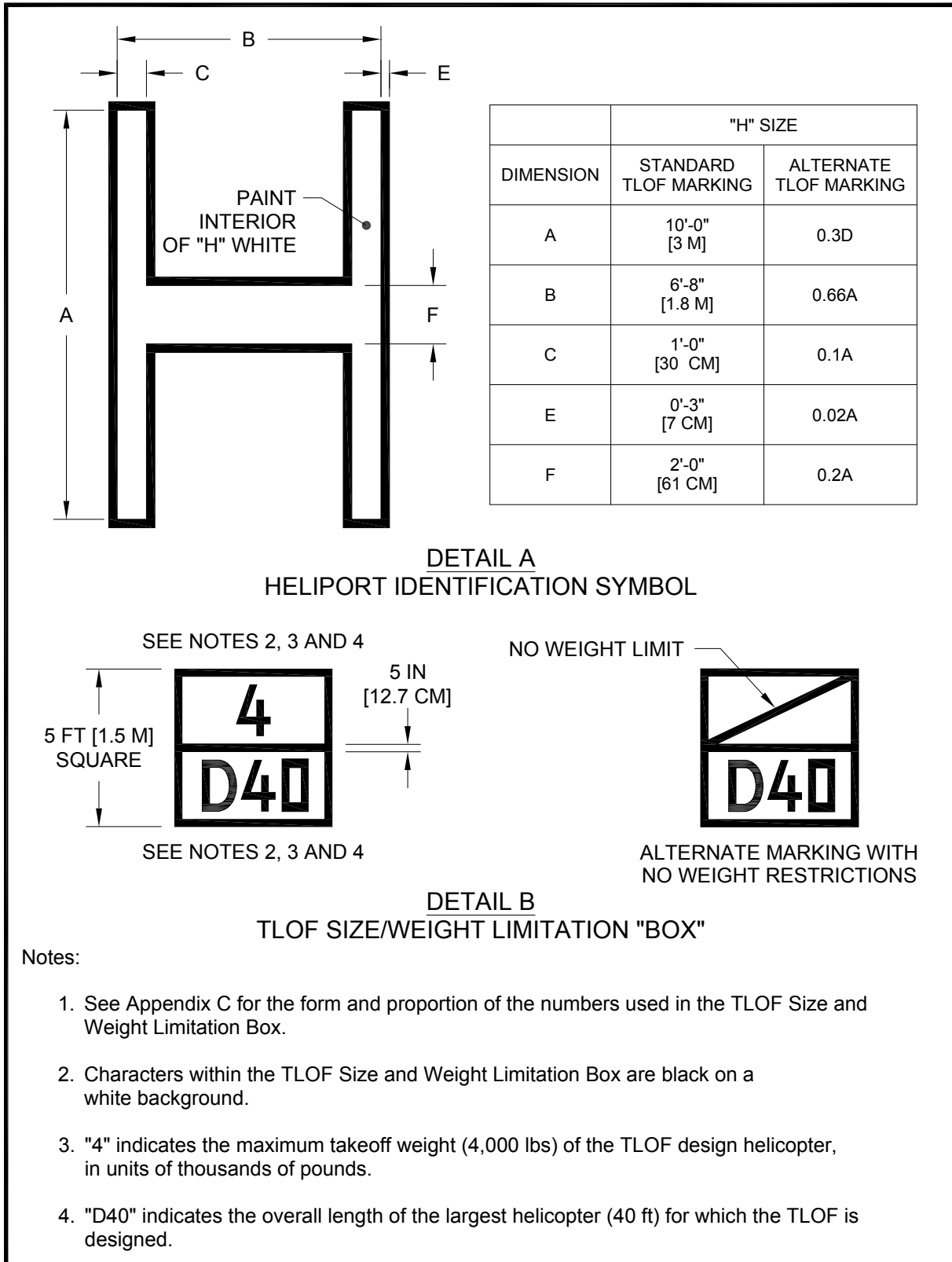
**(1) FATO perimeter marking.** Define the perimeter of a load-bearing FATO with markers and/or lines. Do not mark the FATO perimeter if any portion of the FATO is not a load-bearing surface. In such cases, mark the perimeter of the LBA (see paragraph (b) below).

**(a) Paved FATO.** Define the perimeter of a paved load-bearing FATO with a 12-inch-wide (30 cm) dashed white line. Define the corners of the FATO. The perimeter marking segments are approximately 5 feet (1.5 m) in length, and with end-to-end spacing of approximately 5 feet (1.5 m). See Figure 2–25.

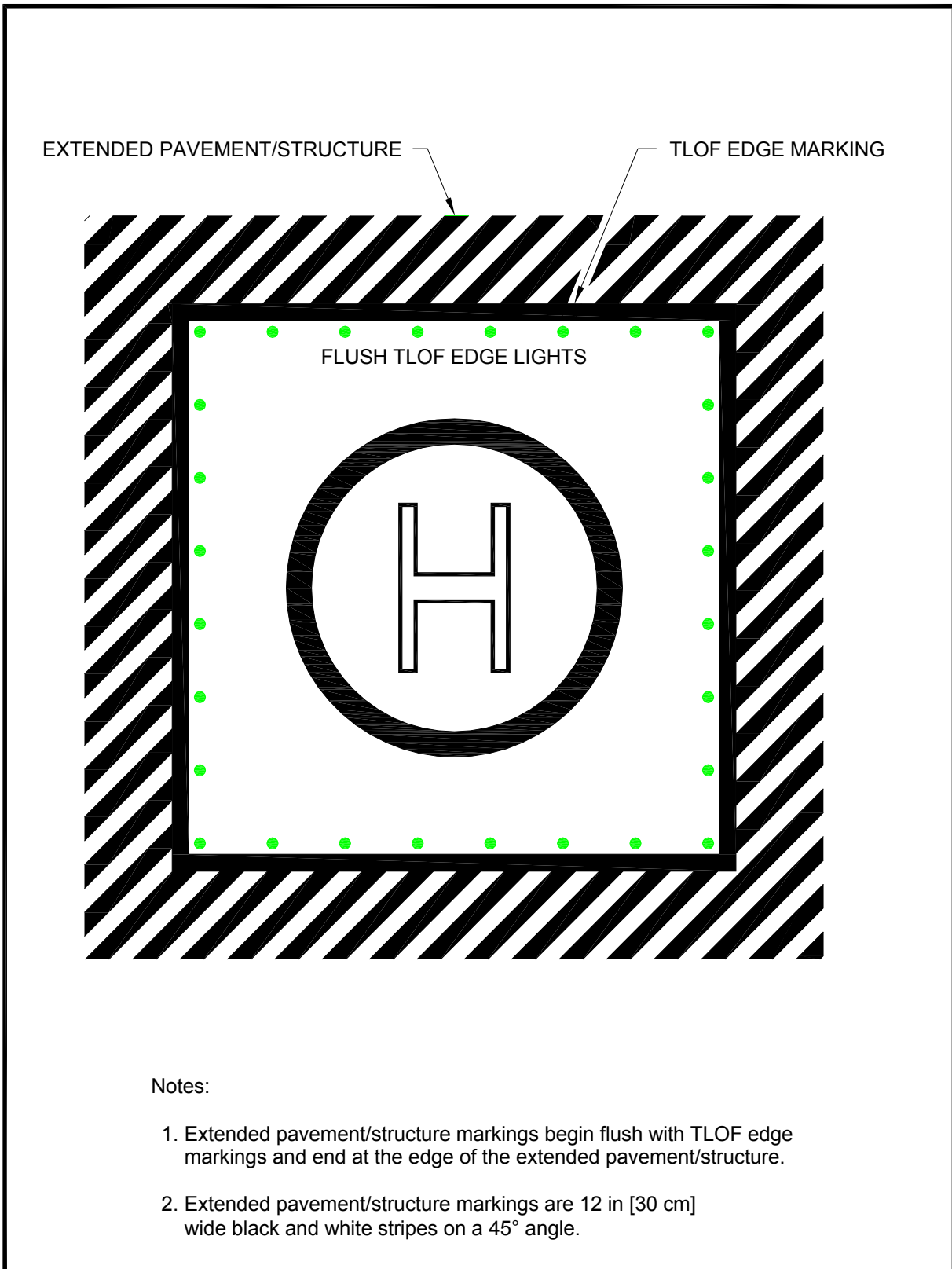
**(b) Unpaved FATO.** Define the perimeter of an unpaved load-bearing FATO with 12-inch-wide (30 cm), flush, in-ground markers. Define the corners of the FATO. The rest of the perimeter markers are approximately 5 feet (1.5 m) in length, and have end-to-end spacing of approximately 5 feet (1.5 m). See Figure 2–26.



**Figure 2-22. Standard and Alternate TLOF Marking:  
General Aviation**

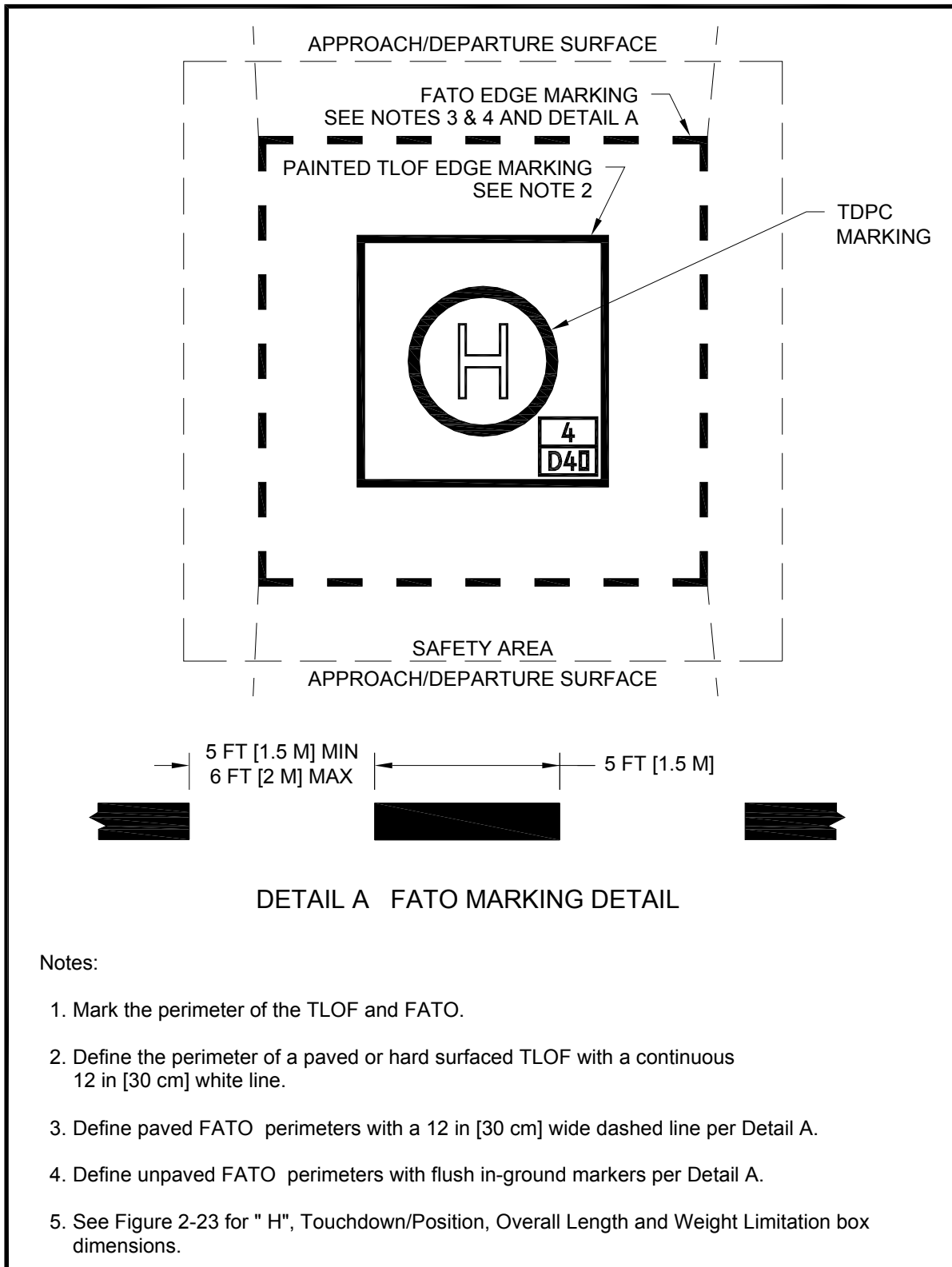


**Figure 2-23. Standard Heliport Identification Symbol, TLOF Size and Weight Limitations: General Aviation**

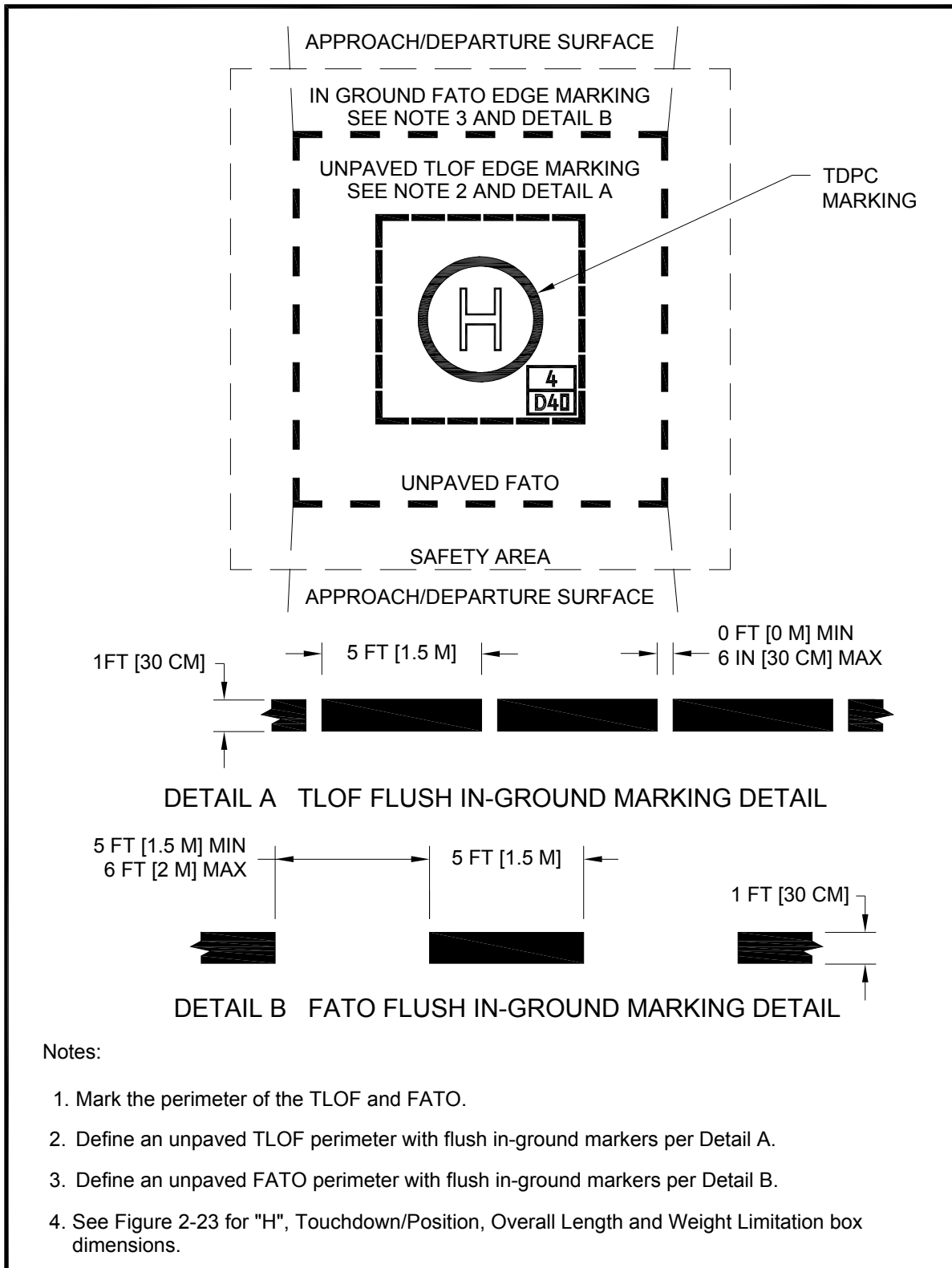


**Figure 2–24. Extended Pavement / Structure Marking: General Aviation**





**Figure 2–25. Paved TLOF/Paved FATO –  
Paved TLOF/ Unpaved FATO – Marking: General Aviation**



**Figure 2-26. Unpaved TLOF/Unpaved FATO – Marking: General Aviation**

**e. Flight path alignment guidance marking.** An optional flight path alignment guidance marking consists of one or more arrows to indicate the preferred approach/departure direction(s). Mark it on the TLOF, FATO and/or safety area surface as shown in Figure 2–11. The shaft of the each arrow is 18 inches (50 cm) in width and at least 10 feet (3 m) in length. Use a color which provides good contrast against the background color of the surface. An arrow pointing toward the center of the TLOF depicts an approach direction. An arrow pointing away from the center of the TLOF depicts a departure direction. In the case of a flight path limited to a single approach direction or a single departure path, the arrow marking is unidirectional. In the case of a heliport with only a bidirectional approach/takeoff flight path available, the arrow marking is bidirectional.

**f. Taxiway and taxi route markings.**

**(1) Paved taxiway markings.** Mark the centerline of a paved taxiway with a continuous 6-inch (15 cm) yellow line. As an option, mark both edges of the paved portion of the taxiway with two continuous 6-inch (15 cm) wide yellow lines spaced 6 inches (15 cm) apart. Figure 2–13 illustrates taxiway centerline and edge markings.

**(2) Unpaved taxiway markings.** Use either raised or in-ground flush edge markers to provide strong visual cues to pilots. Space them longitudinally at approximately 15-foot (5 m) intervals on straight segments and at approximately 10-foot (3 m) intervals on curved segments. Figure 2–14 and Figure 2–15 illustrate taxiway edge markings.

**(a)** Raised-edge markers are blue, 4 inches (10 cm) in diameter, and 8 inches (20 cm) high, as illustrated in Figure 2–14.

**(b)** In-ground, flush edge markers are yellow, 12 inches (30 cm) wide, and approximately 5 feet (1.5 m) long.

**(3) Raised edge markers in grassy areas.** Tall grass sometimes obscures raised edge markers. Address this issue by using 12-inch (30 cm) diameter solid material disks around the poles supporting the raised markers.

**(4) Taxiway to parking position transition requirements.** For paved taxiways and parking areas, taxiway centerline markings continue into parking positions and become the parking position centerlines.

**g. Helicopter parking position markings.** Helicopter parking positions have the following markings:

**(1) Paved parking position identifications.** Mark parking position identifications (numbers or letters) if there is more than one parking position. These markings are yellow characters 36 inches (91 cm) high. See Figure 2–21 and Figure C–1.

**(2) Rotor diameter circle.** Define the circle of the RD of the largest helicopter that will park at that position with a 6-inch (15 cm) wide, solid yellow line with an outside diameter of RD. In paved areas, this is a painted line (see Figure 2–21). In unpaved areas, use a series of flush markers, 6 inches (15 cm) in width, a maximum of 5 feet (1.5 m) in length, and with end-to-end spacing of approximately 5 feet (1.5 m).

**(3) Touchdown/positioning circle (TDPC) marking.** An optional TDPC marking provides guidance to allow a pilot to touch down in a specific position on paved surfaces. When the pilot's seat is over the marking, the undercarriage will be inside the LBA, and all parts of the helicopter will be clear of any obstacle by a safe margin. A TDPC marking is a yellow circle with an inner diameter of  $\frac{1}{2} D$  and a line width of 18 in (46 cm). Locate a TDPC marking in the center of a parking area. See Figure 2–21 and Figure 2–25. The FAA recommends a TDPC marking for "turn-around" parking areas.

**(4) Maximum length marking.** This marking on paved surfaces indicates the D of the largest helicopter that the position is designed to accommodate (for example, 49). This marking consists of yellow characters at least 36 inches (91 cm) high. See Figure 2–21 and Figure C–1.

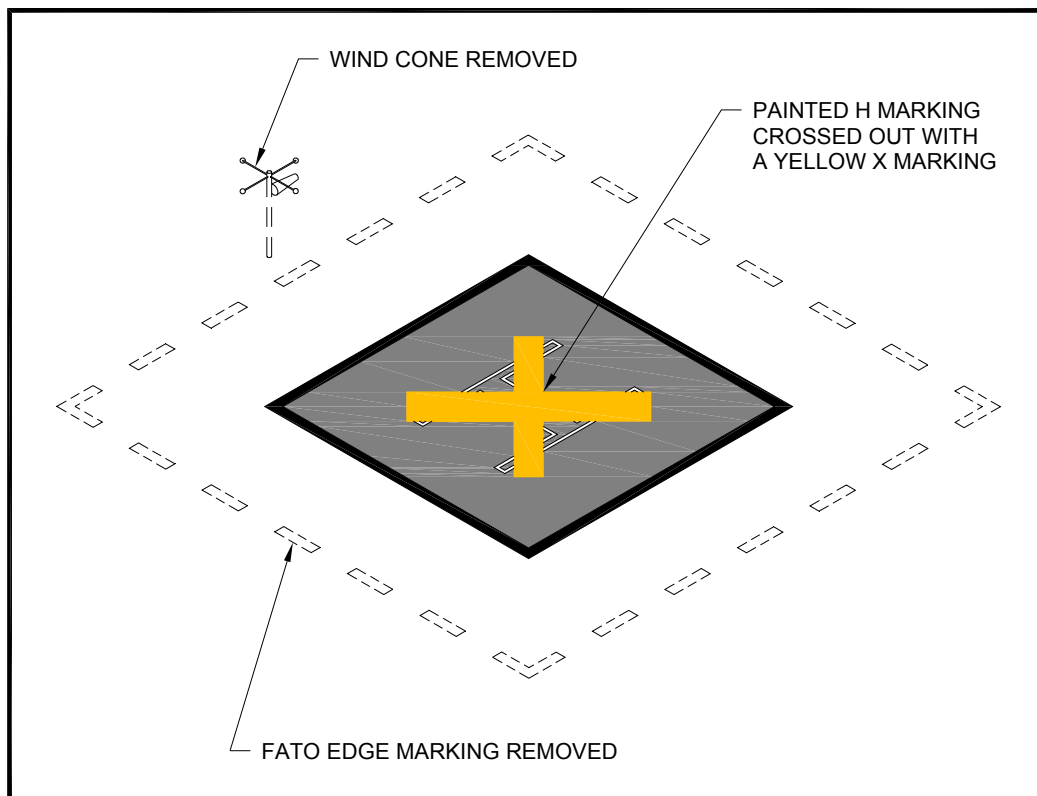
**(5) Parking position weight limit.** If a paved parking position has a weight limitation, mark it in units of 1,000 lbs as illustrated in Figure 2–21. (A 4 indicates a weight-carrying capability of up to 4,000 lbs. Do not use metric equivalents for this purpose.) This marking consists of yellow characters 36 inches (91 cm) high. When necessary to minimize the possibility of being misread, place a bar under the number. See Figure 2–21, Figure 2–25, and Figure C–1.

**(6) Shoulder line markings.** As an option, use shoulder line markings for paved parking areas (Figure 2–21) to ensure safe rotor clearance. Locate a 6-inch (15 cm) wide solid yellow shoulder line, perpendicular to the centerline and extending to the RD marking, so it is under the pilot’s shoulder such that the main rotor of the largest helicopter the position will accommodate will be entirely within the rotor diameter parking circle (see Figure 2–21). Use  $\frac{1}{4}$  D from the center of parking area to define the location of shoulder line. The FAA recommends a shoulder line marking for “taxi-through” and “back-out” parking areas.

**h. Walkways.** Figure 2–21 illustrates one marking scheme.

**i. Closed heliport.** Obliterate all markings of a permanently closed heliport, FATO, or TLOF. If it is impractical to obliterate markings, place a yellow “X” over the “H” as illustrated in Figure 2–27. Make the yellow “X” large enough to ensure early pilot recognition that the heliport is closed. Remove the wind cone(s) and other visual indications of an active heliport.

**j. Marking sizes.** See Appendix C for guidance on the proportions of painted numbers.

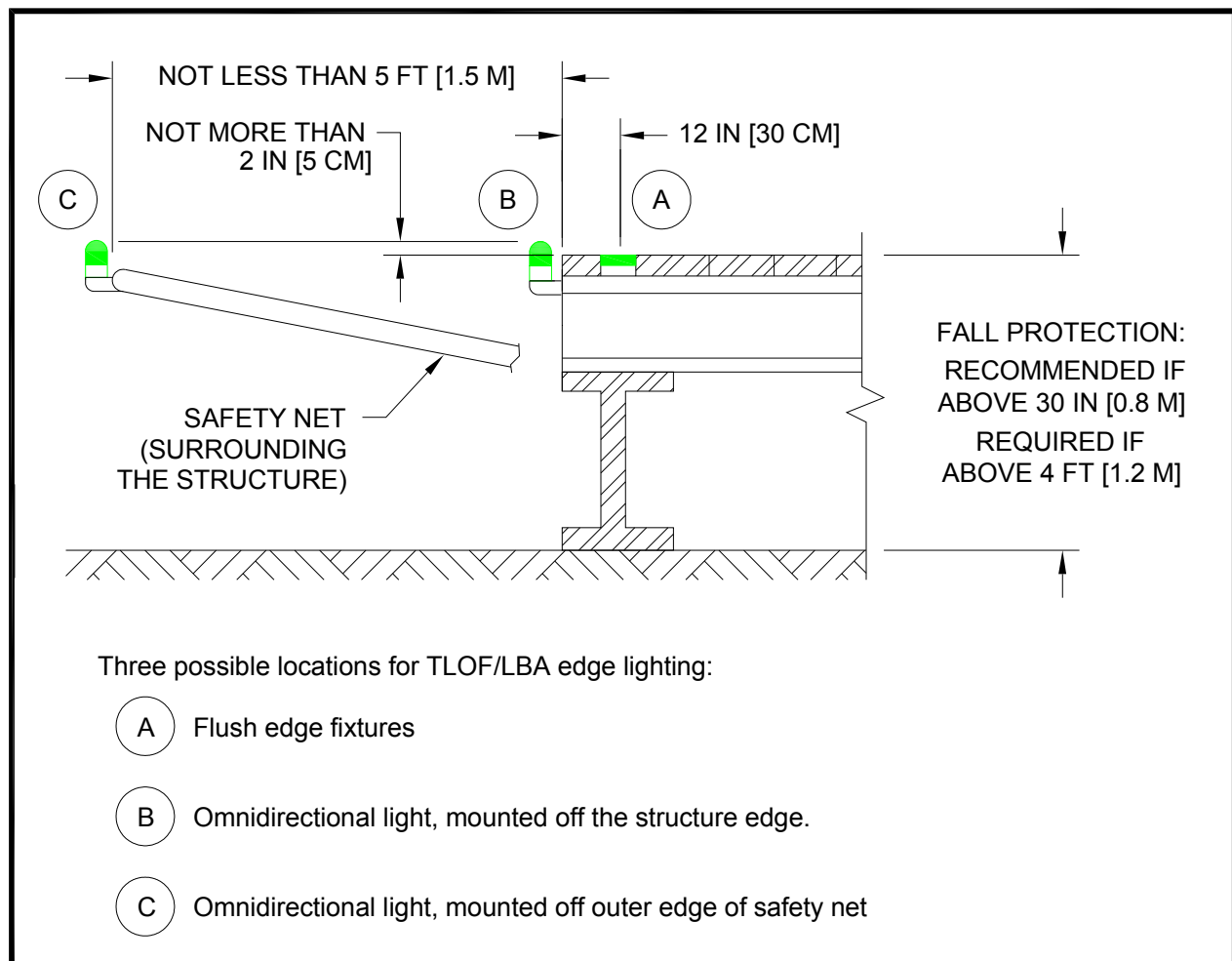


**Figure 2–27. Marking a Closed Heliport: General Aviation**

**216. Heliport lighting.** If the heliport operator intends for the facility to support night operations, light it with FATO and/or TLOF perimeter lights as described below. Design flush light fixtures and installation methods to support point loads of the design helicopter transmitted through a skid or wheel.

**a. TLOF perimeter lights.** Use flush green lights meeting the requirements of FAA Airports Engineering Brief 87, Heliport Perimeter Light for Visual Meteorological Conditions (VMC), to define the TLOF perimeter. Use a minimum of 6. As an option at PPR facilities, use three light fixtures per side of a square or rectangular TLOF. Locate a light at each corner, with additional lights uniformly spaced between the corner lights. Using an odd number of lights on each side will place lights along the centerline of the approach. Define a circular TLOF using an even number of lights, with a minimum of eight, uniformly spaced. Space the lights at a maximum of 25 feet (7.6 m). Locate flush lights within 1 foot (30 cm) inside or outside of the TLOF perimeter.

**(1) Raised TLOF perimeter lights.** As an option, use raised, omnidirectional lights meeting the requirements of EB 87. Locate them on the outside edge of the TLOF or the outer edge of the safety net, as shown in Figure 2–28. Lighting on the outer edge of the safety net provides better visual cues to pilots at a distance from the heliport since it outlines a larger area. Make sure the raised lights do not penetrate a horizontal plane at the FATO elevation by more than 2 inches (5 cm). See Figure 7–3.



**Figure 2–28. Elevated TLOF – Perimeter Lighting: General Aviation**

**(2) PPR facilities.** Use flush lights for PPR heliports. As an option if only the TLOF is load bearing, use raised omnidirectional lights. Locate the raised lights outside and within 10 feet (3 m) of the edge of the TLOF. Make sure the lights do not penetrate a horizontal plane at the TLOF elevation by more than 2 inches (5 cm). As an option when the pavement or structure is larger than the TLOF, mount perimeter lights on the outer edge of the pavement or structure or the inner or outer edge of the safety net.

**b. Load-bearing FATO perimeter lights.** Green lights meeting the requirements of EB 87 define the perimeter of a load bearing FATO. Do not light the FATO perimeter if any portion of the FATO is not a load-bearing surface. Use a minimum of four. As an option at PPR facilities, use a minimum of three flush or raised light fixtures per side of a square or rectangular FATO. Locate a light at each corner, with additional lights uniformly spaced between the corner lights. Using an odd number of lights on each side will place lights along the centerline of the approach. To define a circular FATO, use an even number of lights, with a minimum of eight, uniformly spaced. Space lights at a maximum of 25 feet (7.6 m). Locate flush lights within 1 foot (30 cm) inside or outside of the FATO perimeter (See Figure 2–29). As an option, use a square or rectangular pattern of FATO perimeter lights even if the TLOF is circular. At a distance during nighttime operations, a square or rectangular pattern of FATO perimeter lights provides the pilot with better visual alignment cues than a circular pattern, but a circular pattern may be more effective in an urban environment. In the case of an elevated FATO with a safety net, mount the perimeter lights a similar manner as discussed in paragraph 215.a(1). As an option, locate raised FATO perimeter lights, no more than 8 inches (20 cm) high, 10 feet (3 m) from the FATO perimeter. (See Figure 2–30.) When a heliport on an airport is sited near a taxiway, there may be a concern that a pilot may confuse the green taxiway centerline lights with the FATO perimeter lights. As an option in such cases, use yellow lights as an alternative color for marking the FATO.

**c. Floodlights.** The FAA has not evaluated floodlights for effectiveness in visual acquisition of a heliport. However, if ambient light does not adequately illuminate markings for night operations, use floodlights to illuminate the TLOF, the FATO, and/or the parking area. If possible, mount these floodlights on adjacent buildings to eliminate the need for tall poles. Take care, however, to place floodlights clear of the TLOF, the FATO, the safety area, and the approach/departure surfaces, and transitional surfaces and ensure floodlights and their associated hardware do not constitute an obstruction hazard. Aim floodlights down to provide adequate illumination on the surface. Make sure floodlights that might interfere with pilot vision during takeoff and landings are capable of being turned off by pilot control or at pilot request.

**d. Landing direction lights.** As an option when it is necessary to provide directional guidance, install landing direction lights. Landing direction lights are a configuration of five green, omnidirectional lights meeting the standards of EB 87, on the centerline of the preferred approach/departure path. Space these lights at 15-foot (5 m) intervals beginning at a point not less than 20 feet (6 m) and not more than 60 feet (18 m) from the TLOF perimeter and extending outward in the direction of the preferred approach/departure path, as illustrated in Figure 2–31.

**e. Flight path alignment lights.** As an option, install flight path alignment lights meeting the requirements of EB 87. Place them in a straight line along the direction of approach and/or departure flight paths. If necessary, extend them across the TLOF, FATO, safety area or any suitable surface in the immediate vicinity of the FATO or safety area. Install three or more green lights spaced at 5 feet (1.5 m) to 10 feet (3.0 m). See Figure 2–11.

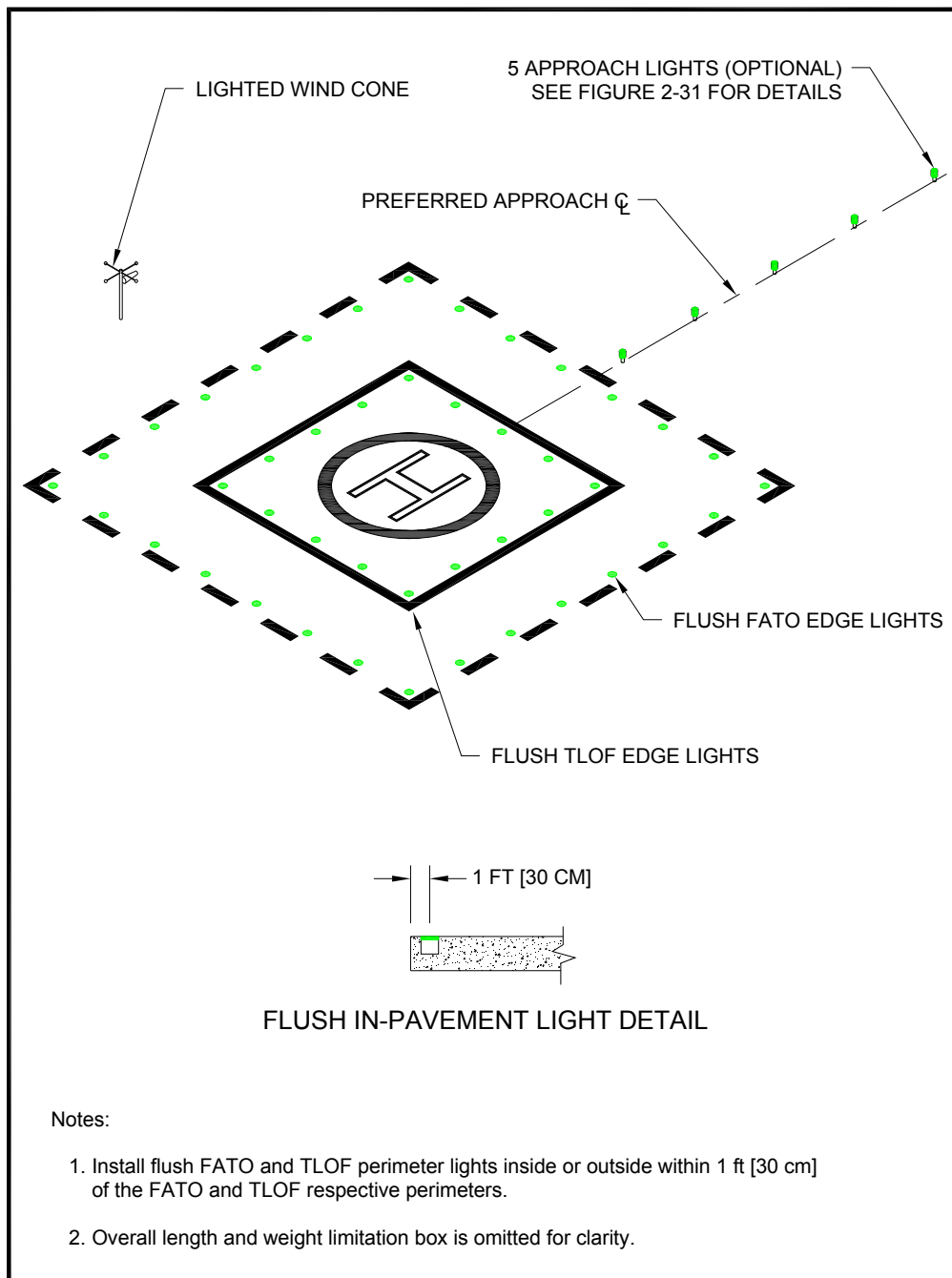
**f. Taxiway and taxi route lighting.**

**(1) Taxiway centerline lights.** Use flush bidirectional green lights meeting the standards of AC 150/5345-46, Specification for Runway and Taxiway Light Fixtures for type L-852A (straight segments) or L-852B (curved segments) to define taxiway centerlines. Space these lights at maximum 50-foot (15 m) longitudinal intervals on straight segments and at maximum 25-foot (7.6 m) intervals on curved segments, using a minimum of four lights to define the curve. Uniformly offset taxiway centerline lights

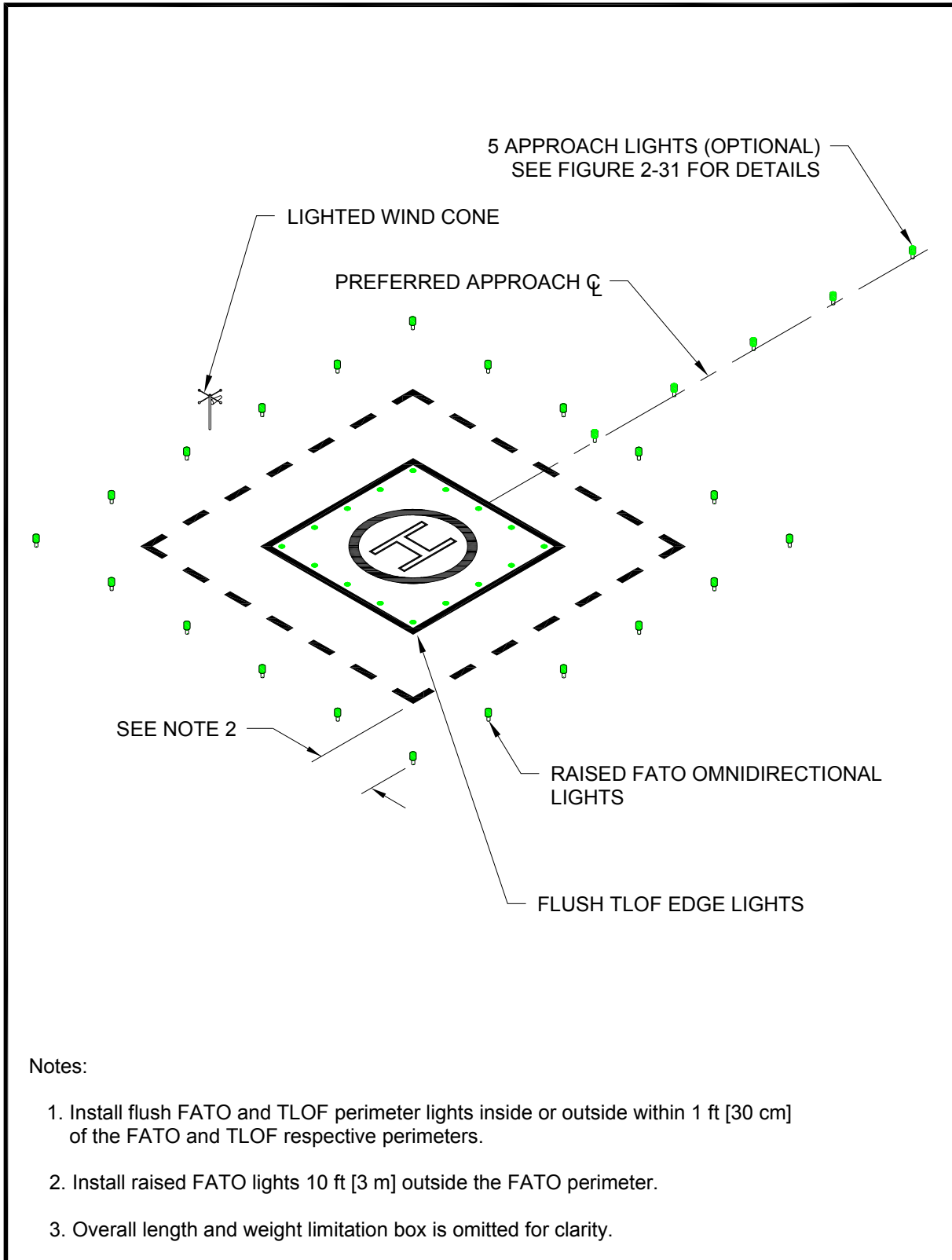
no more than two feet (0.6 m) if necessary to ease painting the taxiway centerline. As an option, use green retroreflective markers meeting requirements for Type I markers in AC 150/5345-39, Specification for L-853, Runway and Taxiway Retroreflective Markers, in lieu of the L-852A or L-852B lighting fixtures.

**(2) Taxiway edge lights.** Use omnidirectional blue lights to light the edges of a taxiway. As an option, use blue retroreflective markers to identify the edges of the taxiway in lieu of lights. Make sure retroreflective markers are no more than 8 inches (20 cm) tall.

**(a) Straight segments.** Space lights at 50-foot (15.2 m) longitudinal intervals on straight segments.



**Figure 2–29. TLOF/FATO Flush Perimeter Lighting: General Aviation**



**Figure 2–30. TLOF Flush and FATO Raised Perimeter Lighting: General Aviation**



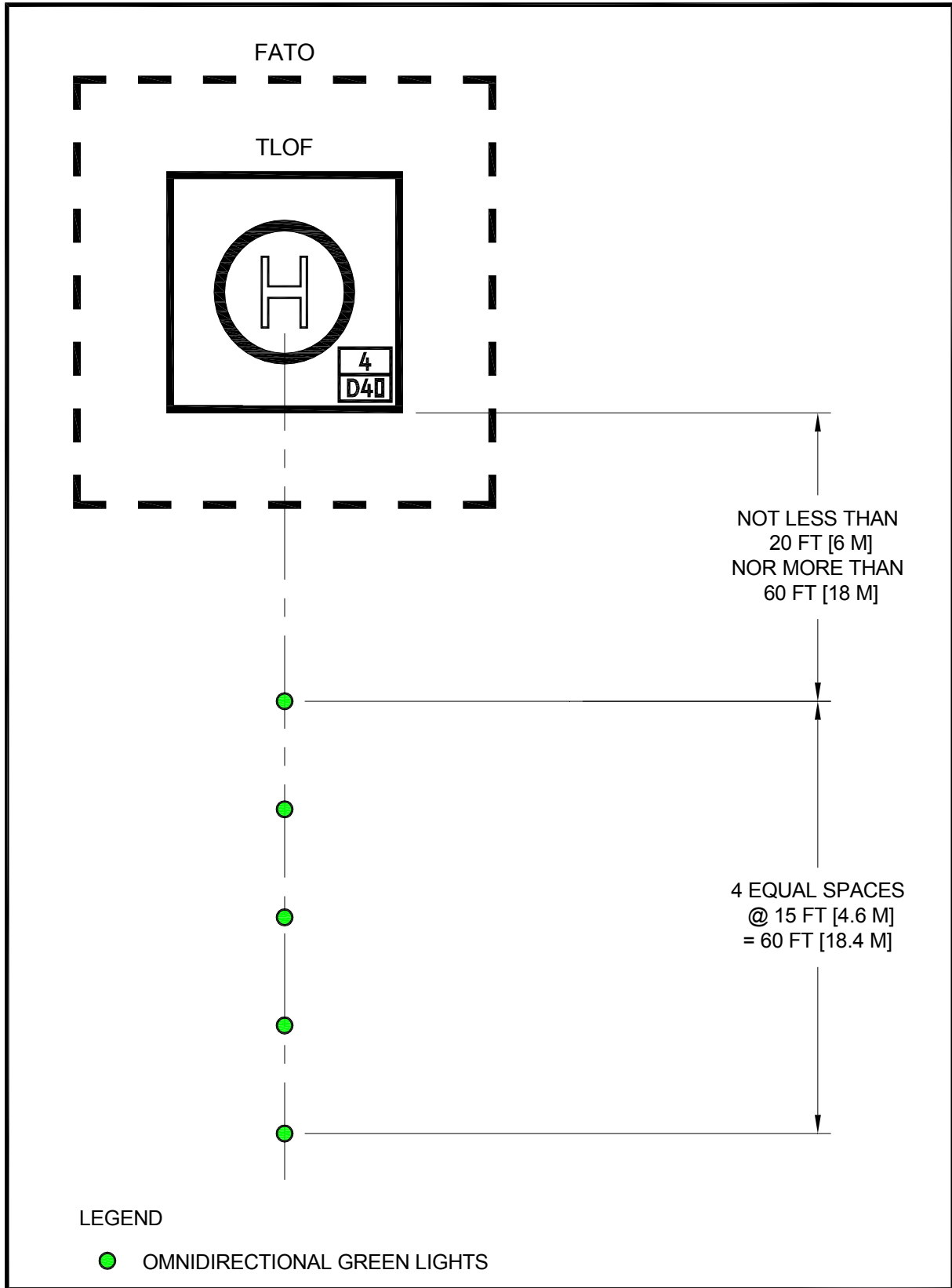


Figure 2–31. Landing Direction Lights: General Aviation

**(b) Curved segments.** Curved taxiway edges require shorter spacing of edge lights. Base the spacing on the radius of the curve. AC 150/5340-30, Design and Installation Detail for Airport Visual Aids, shows the applicable spacing for curves. Space taxiway edge lights uniformly. On curved edges of more than 30 degrees from point of tangency (PT) of the taxiway section to PT of the intersecting surface, install at least three edge lights. For radii not listed in AC 150/5340-30, determine spacing by linear interpolation.

**(c) Paved taxiways.** Use flush lights meeting the standards of AC 150/5345-46 for type L-852T.

**(d) Unpaved taxiways.** Use raised lights meeting the standards of AC 150/5345-46 for type L-861T. The lateral spacing for the lights or reflectors is equal to the RD of the design helicopter, but not more than 35 feet (10.7 m).

**g. Heliport identification beacon.** A heliport identification beacon is optional equipment. It is the most effective means to aid the pilot in visually locating the heliport. Locate the beacon, flashing white/green/yellow at the rate of 30 to 45 flashes per minute, on or close to the heliport. Find guidance on heliport beacons in AC 150/5345-12, Specification for Airport and Heliport Beacon. As an option, allow the beacon to be pilot controllable such that it is “on” only when needed.

**217. Marking and lighting of difficult-to-see objects.** It is difficult for a pilot to see unmarked wires, antennas, poles, cell towers, and similar objects, even in the best daylight weather, in time to take evasive action. While pilots can avoid such objects during en route operations by flying well above them, approaches and departures require operations near the ground where obstacles may be a factor. This paragraph discusses the marking and lighting of objects near, but outside and below the approach/departure surface. Find guidance on marking and lighting objects in AC 70/7460-1, Obstruction Marking and Lighting.

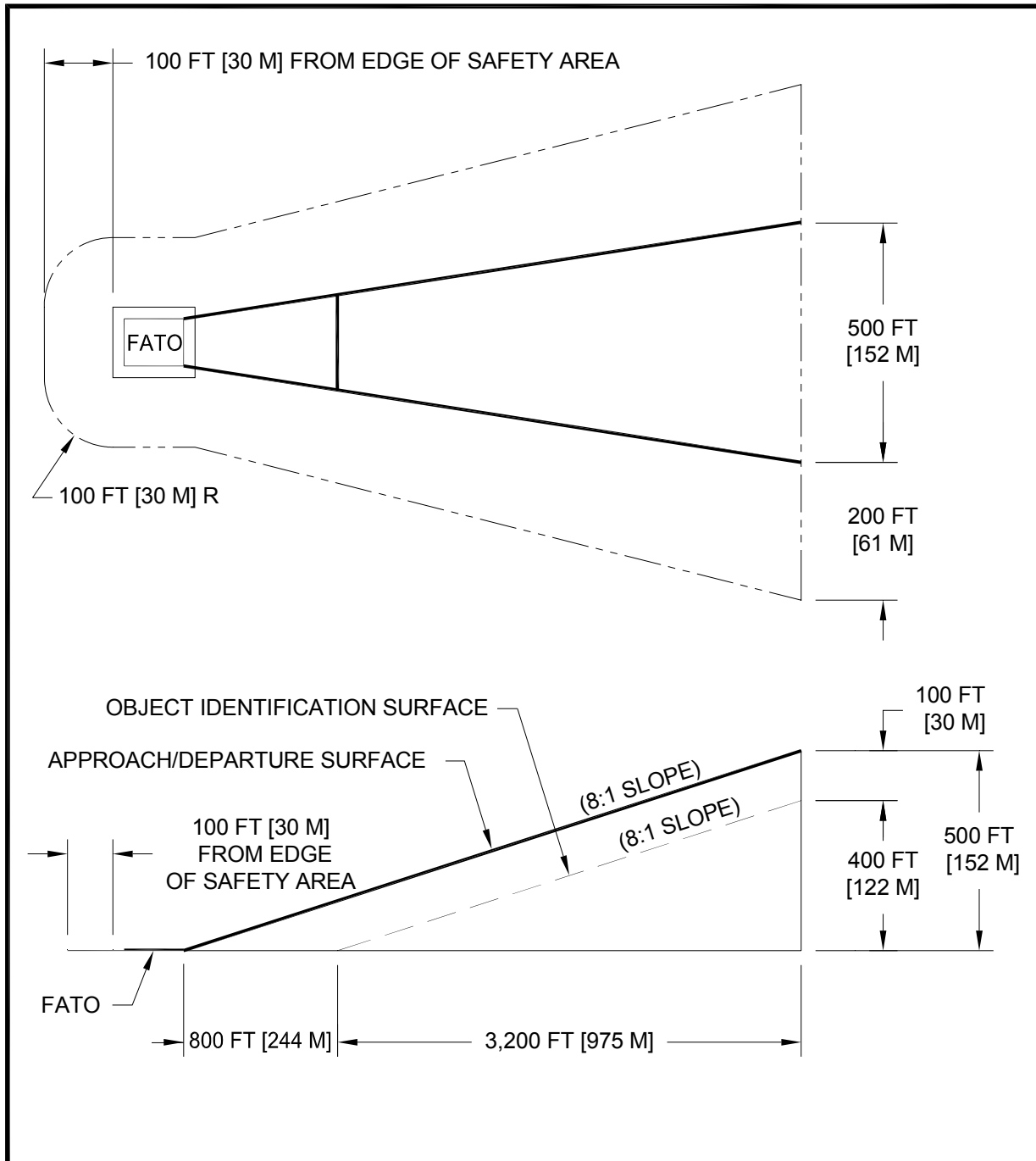
**a. Airspace.** If difficult-to-see objects penetrate the applicable object identification surfaces illustrated in Figure 2–32 and Figure 2–33, mark these objects to make them more conspicuous. If a heliport supports operations between dusk and dawn, light these difficult-to-see objects. The object identification surfaces in Figure 2–32 and Figure 2–33 are described as follows:

**(1)** In all directions from the safety area except under the approach/departure paths, the object identification surface starts at the safety area perimeter and extends out horizontally for a distance of 100 feet (30.5 m).

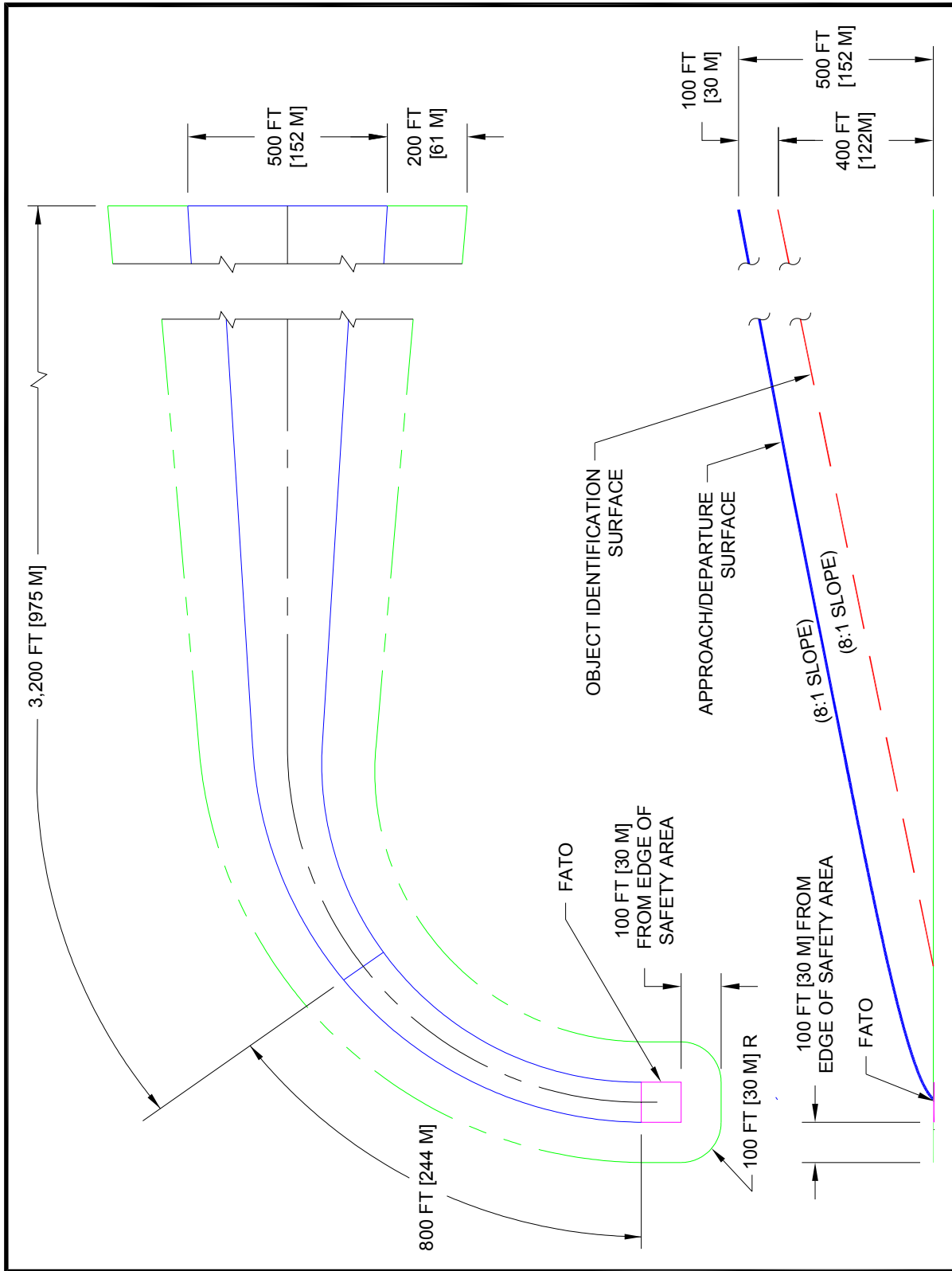
**(2)** Under the approach/departure surface, the object identification surface starts from the outside edge of the FATO and extends horizontally out for a distance of 800 feet (244 m) along the approach path. From this point, the object identification surface extends out for an additional distance of 3,200 feet (975 m) along the approach path while rising on an 8:1 slope (8 units horizontal in 1 unit vertical). From the point 800 feet (244 m) from the FATO perimeter, the object identification surface is 100 feet (30.5 m) beneath the approach/departure surface.

**(3)** The width of this object identification surface under the approach/departure surface increases as a function of distance from the safety area. From the safety area perimeter, the object identification surface extends laterally to a point 100 feet (30.5 m) outside the safety area perimeter. At the upper end of the surface, the object identification surface extends laterally 200 feet (61 m) on either side of the approach/departure path.

**b. Shielding of objects.** Title 14 CFR Part 77.9, Construction or alteration requiring notice, provides that if there are a number of objects close together, it may not be necessary to mark all of them if they are shielded. To meet the shielding guidelines, part 77 requires that an object “be shielded by existing structures of a permanent and substantial nature or by natural terrain or topographic features of equal or greater height, and will be located in the congested area of a city, town, or settlement where the shielded structure will not adversely affect safety in air navigation.”



**Figure 2–32. Airspace Where Marking and Lighting are Recommended:  
Straight Approach: General Aviation**



**Figure 2-33. Airspace Where Marking and Lighting are Recommended:  
Curved Approach: General Aviation**

**c. Equipment/object marking.** Make heliport maintenance and servicing equipment, as well as other objects used in the airside operational areas, conspicuous with paint, reflective paint, reflective tape, or other reflective markings. Reference AC 150/5210-5, Painting, Marking, and Lighting of Vehicles Used on an Airport.

**218. Safety considerations.** Consider the following safety enhancements in the design of a heliport. Address other areas, such as the effects of rotor downwash, based on site conditions and the design helicopter.

**a. Security.** Provide a heliport with appropriate means of keeping the operational areas clear of people, animals, and vehicles. Use a method to control access depending upon the helicopter location and types of potential intruders.

**(1) Safety barrier.** At ground-level general aviation heliports, erect a safety barrier around the helicopter operational areas in the form of a fence or a wall. Construct the barrier no closer to the operation areas than the outer perimeter of the safety area. Make sure the barrier does not penetrate any approach/departure (primary or transitional) surface. If necessary in the vicinity of the approach/departure paths, install the barrier well outside the outer perimeter of the safety area.

**(2)** Make sure any barrier is high enough to present a positive deterrent to persons inadvertently entering an operational area and yet low enough to be non-hazardous to helicopter operations.

**(3)** Control access to airside areas in a manner commensurate with the barrier (for example, build fences with locked gates). Display a cautionary sign similar to that illustrated in Figure 2–34 at access points.

**b. Rescue and fire-fighting services.** Heliports are subject to state and local rescue and fire-fighting regulations. Provide a fire hose cabinet or extinguisher at each access gate/door and each fueling location. Locate fire hose cabinets, fire extinguishers, and other fire-fighting equipment near, but below the level of, the TLOF. Find additional information in various NFPA publications. For more reference material, see Appendix D.

**c. Communications.** Use a Common Traffic Advisory Frequency (CTAF) radio to provide arriving helicopters with heliport and traffic advisory information but do not use this radio to control air traffic. Contact the Federal Communications Commission (FCC) for information on CTAF licensing.

**d. Weather information.** An automated weather observing system (AWOS) measures and automatically broadcasts current weather conditions at the heliport site. When installing an AWOS, locate it at least 100 feet (30 m) and not more than 700 feet (213 m) from the TLOF and such that its instruments will not be affected by rotor wash from helicopter operations. Find guidance on AWOS systems in AC 150/5220-16, Automated Weather Observing Systems (AWOS) for Non-Federal Applications, and FAA Order 6560.20, Siting Criteria for Automated Weather Observing Systems (AWOS). Other weather observing systems will have different siting criteria.

**e. Winter operations.** Swirling snow raised by a helicopter's rotor wash can cause the pilot to lose sight of the intended landing point and/or hide objects that need to be avoided. Design the heliport to accommodate the methods and equipment used for snow removal. Design the heliport to allow the snow to be removed sufficiently so it will not present an obstruction hazard to the tail rotor, main rotor, or undercarriage. Find guidance on winter operations in AC 150/5200-30, Airport Winter Safety and Operations.

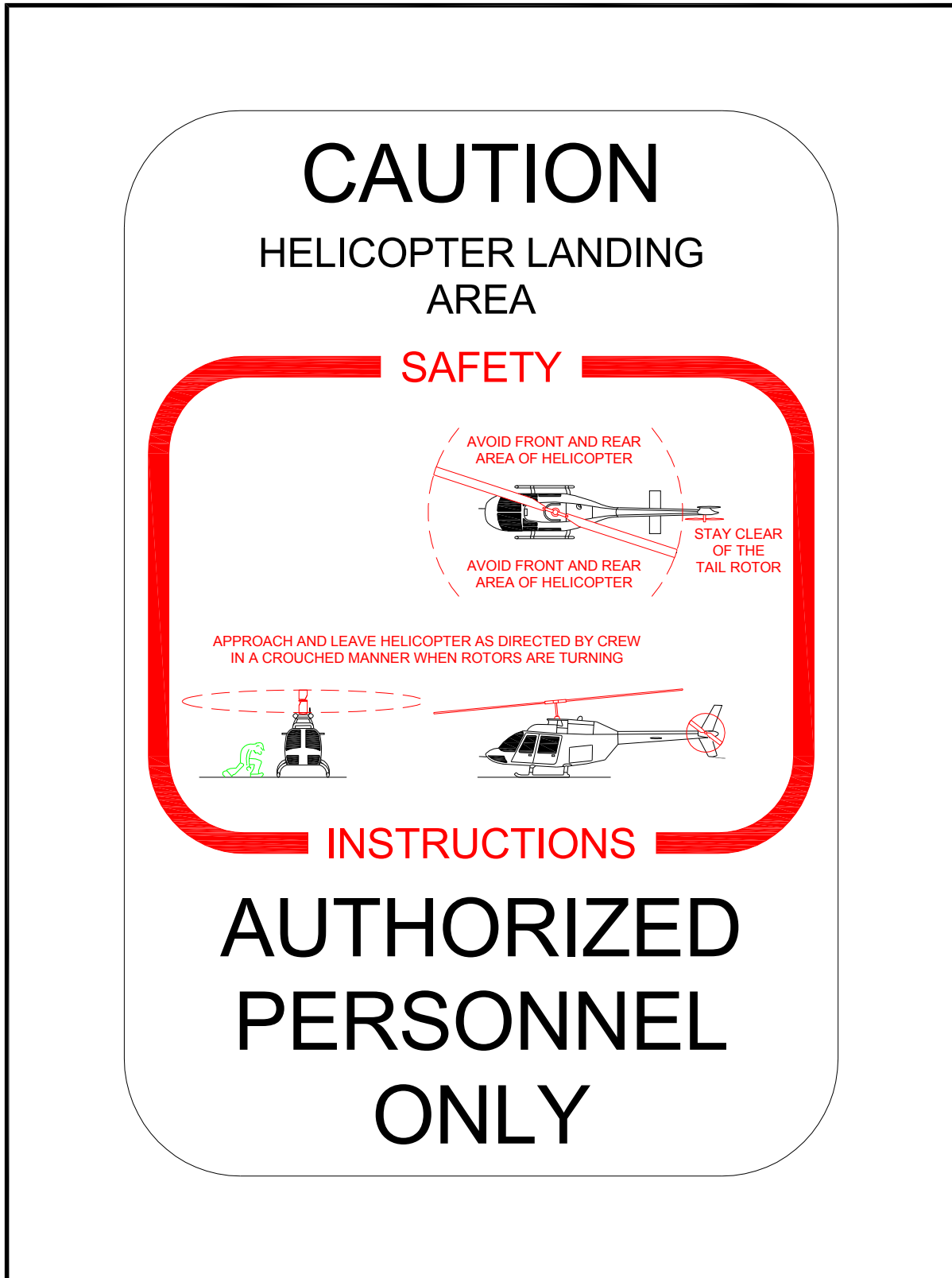


Figure 2–34. Caution Sign: General Aviation

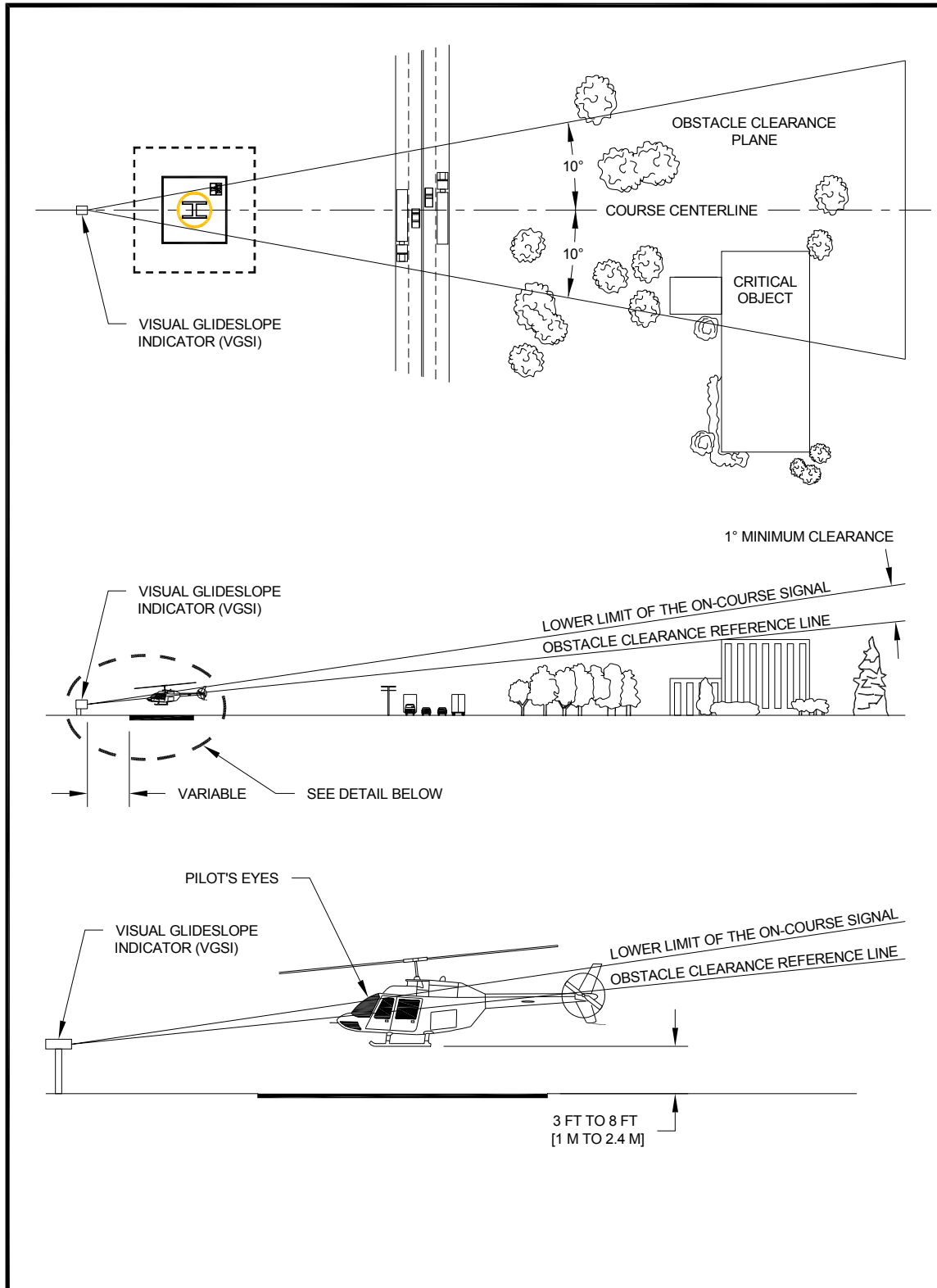


Figure 2-35. Visual Glideslope Indicator Siting and Clearance Criteria: General Aviation

**219. Visual glideslope indicators (VGSI).** A visual glideslope indicator (VGSI) provides pilots with visual vertical course and descent cues. Install the VGSI such that the lowest on-course visual signal provides a minimum of 1 degree of clearance over any object that lies within 10 degrees of the approach course centerline.

**a. Siting.** The optimum location of a VGSI is on the extended centerline of the approach path at a distance that brings the helicopter to a hover with the undercarriage between 3 and 8 feet (0.9 to 2.5 m) above the TLOF. Figure 2–35 illustrates VGSI clearance criteria. To properly locate the VGSI, estimate the vertical distance from the undercarriage to the pilot’s eye.

**b. Control of the VGSI.** As an option, allow the VGSI to be pilot controllable such that it is “on” only when needed.

**c. VGSI needed.** A VGSI is an optional feature. However, provide a VGSI if one or more of the following conditions exist, especially at night:

(1) Obstacle clearance, noise abatement, or traffic control procedures require a particular slope to be flown.

(2) The environment of the heliport provides few visual surface cues.

**d. Additional guidance.** Find additional guidance in AC 150/5345-52, Generic Visual Glideslope Indicators (GVGI), and AC 150/5345-28, Precision Approach Path Indicator (PAPI) Systems.

**220. Terminal facilities.** A heliport terminal provides curbside access for passengers using private autos, taxicabs, and public transit vehicles. Public waiting areas need the usual amenities, and a counter for rental car services may be desirable. Design passenger auto parking areas to accommodate current requirements, with the ability to expand them to meet future requirements. Readily available public transportation may reduce the requirement for employee and service personnel auto parking spaces. Build attractive and functional heliport terminal buildings or sheltered waiting areas. Find guidance on designing terminal facilities in AC 150/5360-9, Planning and Design of Airport Terminal Building Facilities at Non-Hub Locations. At PPR heliports, the number of people using the facility may be so small that there is no need for a terminal building, and minimal needs for other facilities and amenities.

**221. Zoning and compatible land use.** The FAA encourages general aviation heliport operators to promote the adoption of the following zoning measures where state and local statutes permit to ensure the heliport will continue to be available and to protect the investment in the facility.

**a. Zoning to limit building/object heights.** Find general guidance on drafting an ordinance that would limit building and object heights in AC 150/5190-4, A Model Zoning Ordinance to Limit Height of Objects Around Airports. Substitute the heliport surfaces for the airport surfaces in the model ordinance.

**b. Zoning for compatible land use.** The FAA encourages public agencies to enact zoning ordinances to control the use of property within the HPZ and the approach/departure path environment, restricting activities to those that are compatible with helicopter operations. See paragraph 211.

**c. Air rights and property easements.** Use air rights and property easements as options to prevent the encroachment of obstacles in the vicinity of a heliport.



### Chapter 3. Transport Heliports

**301. General.** A transport heliport is intended to accommodate air carrier operators providing scheduled service, or unscheduled service with large helicopters.

**302. Applicability.** The standards in this chapter apply to projects funded under the Airport Improvement Program (AIP) or Passenger Facility Charge (PFC) program. For other projects/heliports, these standards are the FAA's recommendations for designing all transport heliports. The design standards in this chapter assume there will never be more than one helicopter within the final approach and takeoff area (FATO) and the associated safety area. If there is a need for more than one touchdown and lift-off area (TLOF) at a heliport, locate each TLOF within its own FATO and within its own safety area. Figure 3-1 illustrates a typical transport heliport.

**303. Access by individuals with disabilities.** Various laws require heliports operated by public entities and those receiving federal financial assistance to meet accessibility requirements. See paragraph 114.

**304. Heliport site selection.**

**a. Long term planning.** Public agencies and others planning to develop a transport heliport consider the possible future need for instrument operations and future expansion.

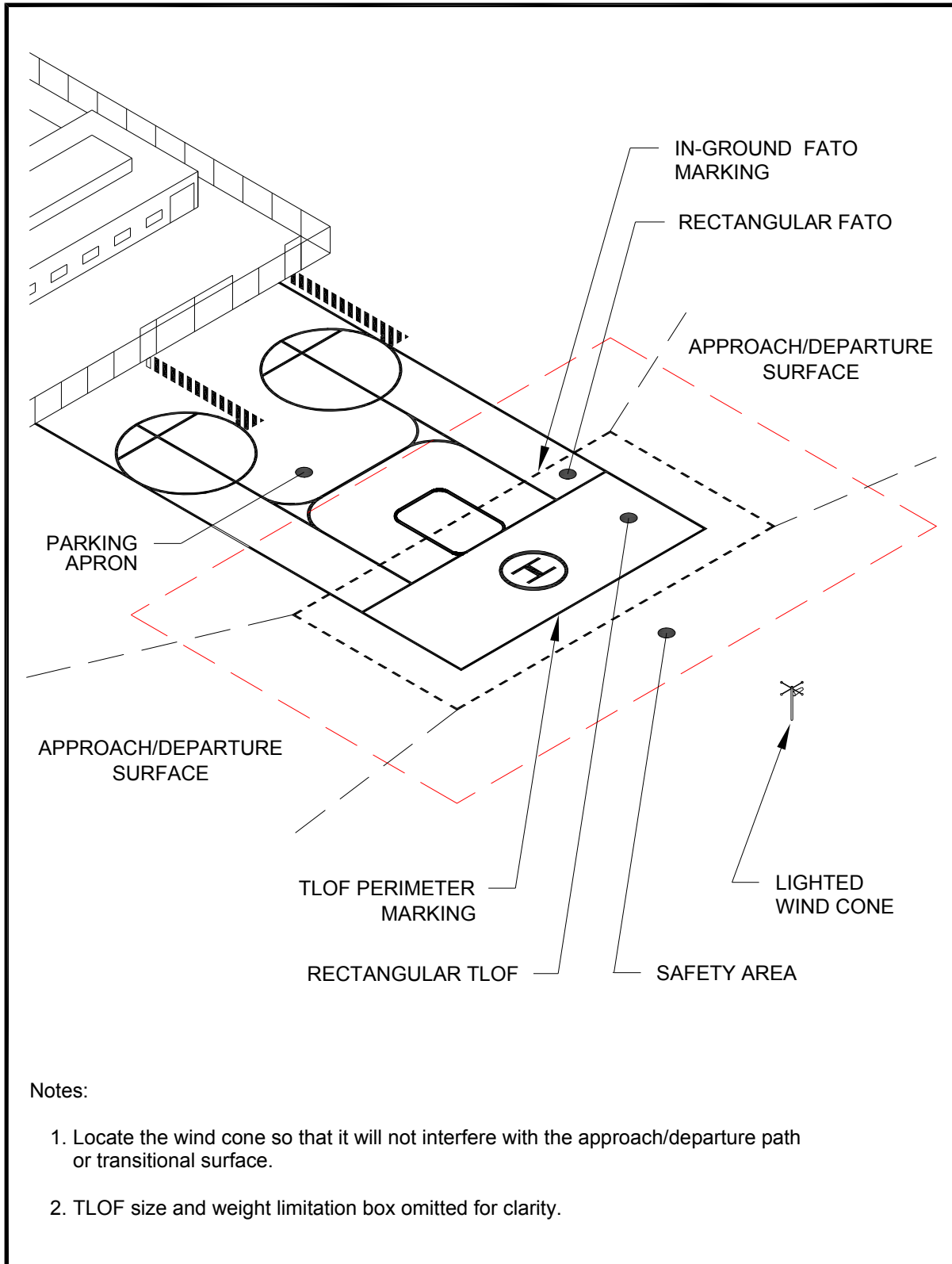
**b. Property requirements.** The property needed for a transport heliport depends upon the volume and types of users and the scope of amenities provided. Property requirements for helicopter operators and for passenger amenities frequently exceed that required for "airside" purposes.

**c. Turbulence.** Air flowing around and over buildings, stands of trees, terrain irregularities, etc. can create turbulence on ground-level and roof-top heliports that may affect helicopter operations. Where the FATO is located near the edge and top of a building or structure, or within the influence of turbulent wakes from other buildings or structures, assess the turbulence and airflow characteristics in the vicinity of, and across the surface of the FATO to determine if an air-gap between the roof, roof parapet or supporting structure, and/or some other turbulence mitigating design measure is necessary. FAA Technical Report FAA/RD-84/25, Evaluating Wind Flow around Buildings on Heliport Placement addresses the wind's effect on helicopter operations. Take the following actions in selecting a site to minimize the effects of turbulence.

**(1) Ground-level heliports.** Features such buildings, trees, and other large objects can cause air turbulence and affect helicopter operations from sites immediately adjacent to them. Therefore, locate the landing and takeoff area away from such objects in order to minimize air turbulence in the vicinity of the FATO and the approach/departure paths.

**(2) Elevated heliports.** Establishing a 6 foot (1.8 m) or more air gap on all sides above the level of the roof will generally minimize the turbulent effect of air flowing over the roof edge. If an air gap is included in the design, keep it free at all times of objects that would obstruct the airflow. If it is not practical to include an air gap or some other turbulence mitigating design measure where there is turbulence, operational limitations may need to be considered under certain wind conditions (see paragraph 101).

**d. Electromagnetic effects.** Nearby electromagnetic devices, such as a large ventilator motor, elevator motor or other large electrical consumer may cause temporary aberrations in the helicopter magnetic compass and interfere with other onboard navigational equipment.



**Figure 3-1. Typical Transport Heliport: Transport**

**305. Basic layout.** The heliport consists of a TLOF contained within a FATO. A safety area surrounds the FATO. The relationship of the TLOF to the FATO and the safety area is shown in Figure 3–2. A FATO contains only one TLOF. Provide appropriate approach/departure airspace to allow safe approaches to and departures from landing sites. To the extent feasible, align the preferred approach/departure path with the predominant winds (see paragraph 309). Where helicopter flight manuals specify the minimum size required for operations, take the size into account in the design of the facility.

**306. Touchdown and liftoff area (TLOF).**

**a. TLOF location.** The TLOF of a transport heliport is normally at ground level but may be developed with the TLOF located on a pier or, when carefully planned, on the roof of a building. The TLOF is centered in the load-bearing area (LBA), and on the major axis of the FATO.

**b. TLOF size.** The TLOF is a square or rectangular surface whose minimum length and width is the rotor diameter (RD) of the design helicopter but not less than 50 feet (15.2 m). Increasing the LBA centered on the TLOF may provide some safety and operational advantages.

**c. Elongated TLOF:** An elongated TLOF can provide an increased safety margin and greater operational flexibility. As an option, design an elongated TLOF with a landing position in the center and two takeoff positions, one at either end, as illustrated in Figure 3–3. Design the landing position to have a minimum length of the RD of the design helicopter, but not less than 50 feet (15.2 m). If the TLOF is elongated, also provide an elongated FATO.

**d. Ground-level TLOF surface characteristics.**

**(1) Design loads.** Design the TLOF and any supporting TLOF structure to be capable of supporting the dynamic loads of the design helicopter.

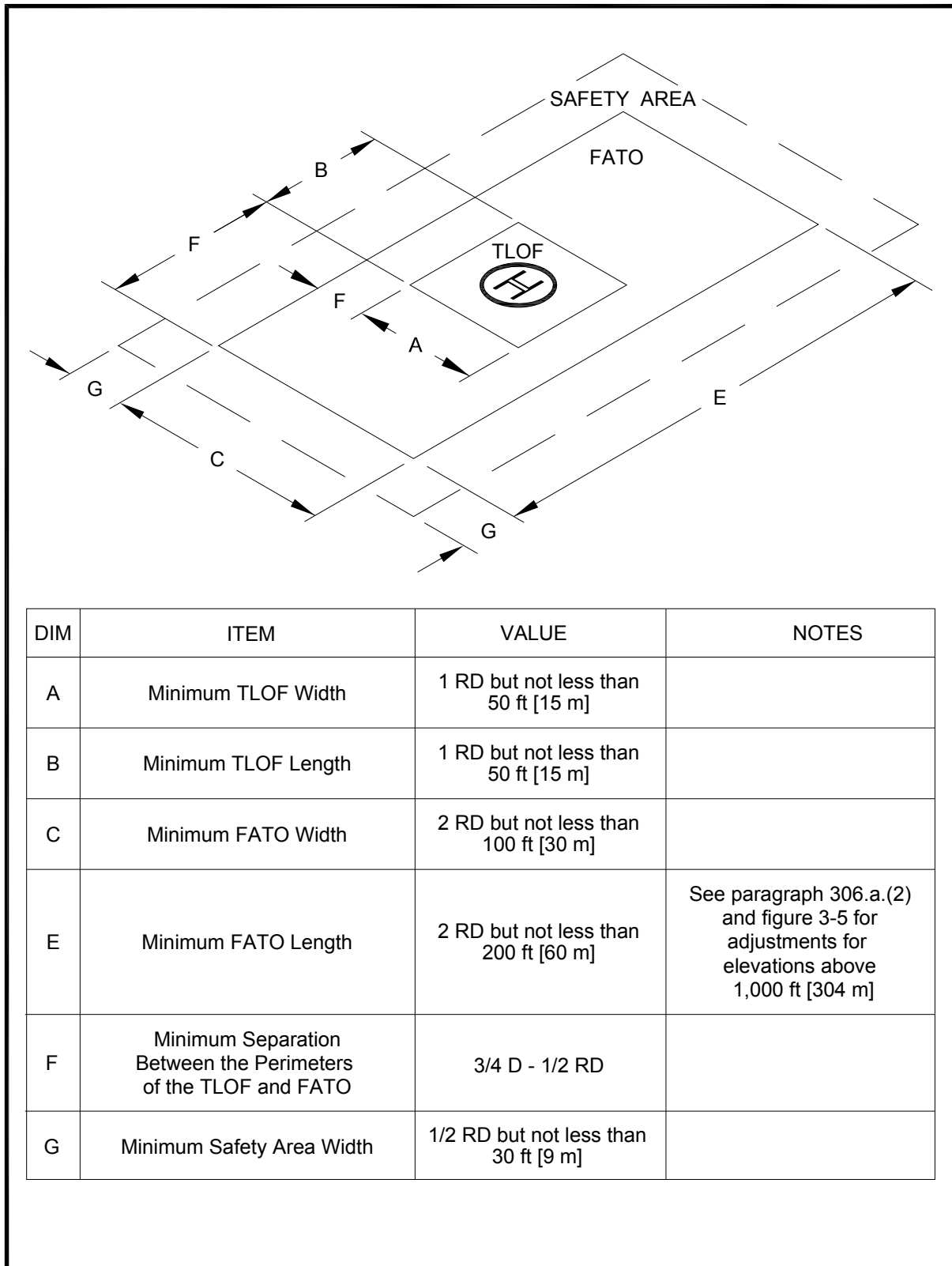
**(2) Paving.** Construct the TLOF of portland cement concrete (PCC) (see AC 150/5370-10, Standards for Specifying Construction of Airports items P-501) where feasible. Use a broomed or roughened pavement finish to provide a skid-resistant surface for helicopters and non-slippery footing for people.

**e. Rooftop and other elevated TLOFs.**

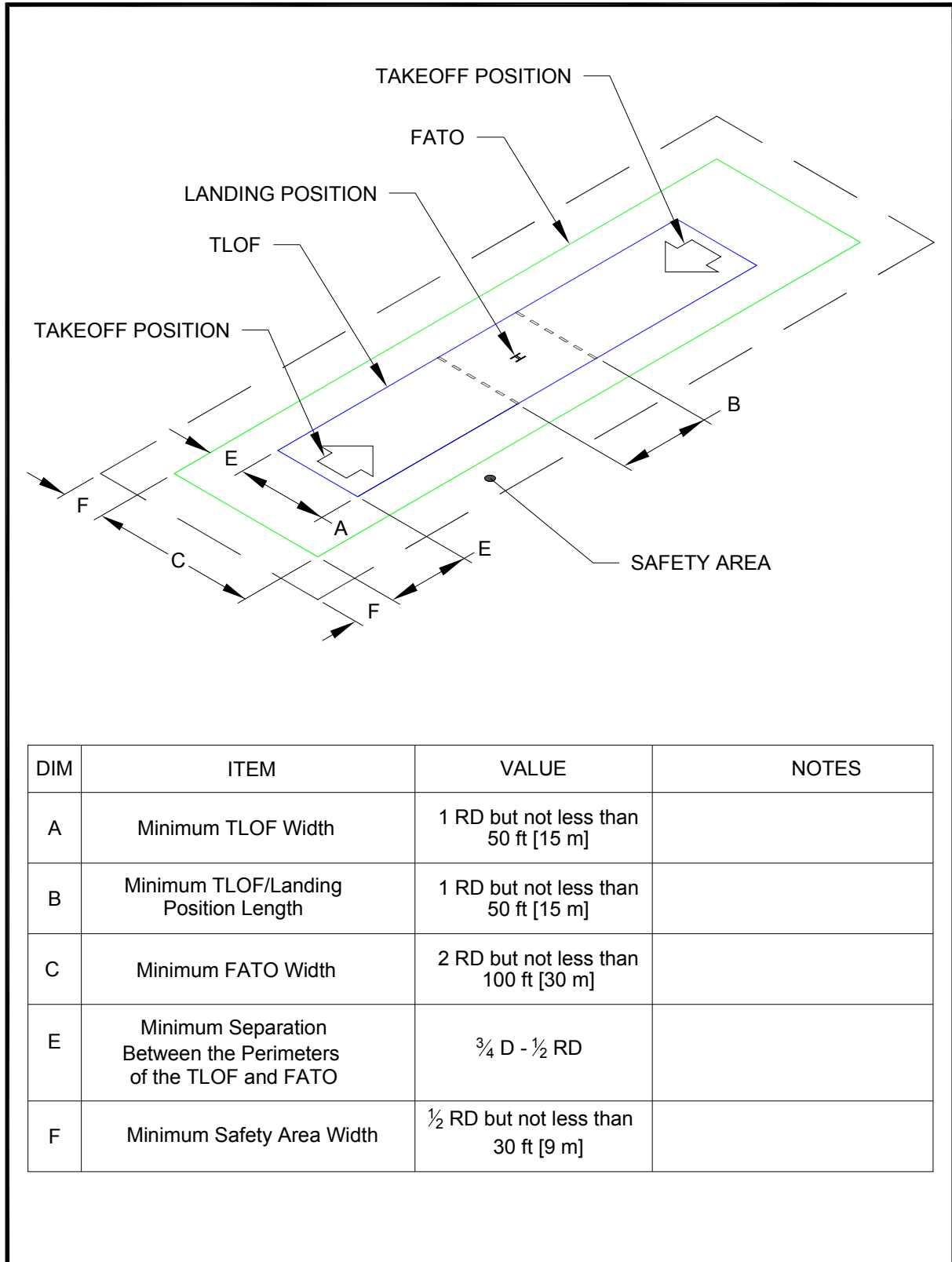
**(1) Design loads.** Design elevated TLOFs and any TLOF supporting structure to be capable of supporting the dynamic loads of the design helicopter. An elevated heliport is illustrated in Figure 3–4.

**(2) TLOF surface characteristics.** Construct rooftop and other elevated heliport TLOFs of metal, concrete, or other materials subject to local building codes. Provide TLOF surfaces with a skid-resistant surface finish for helicopters and non-slippery footing for people.

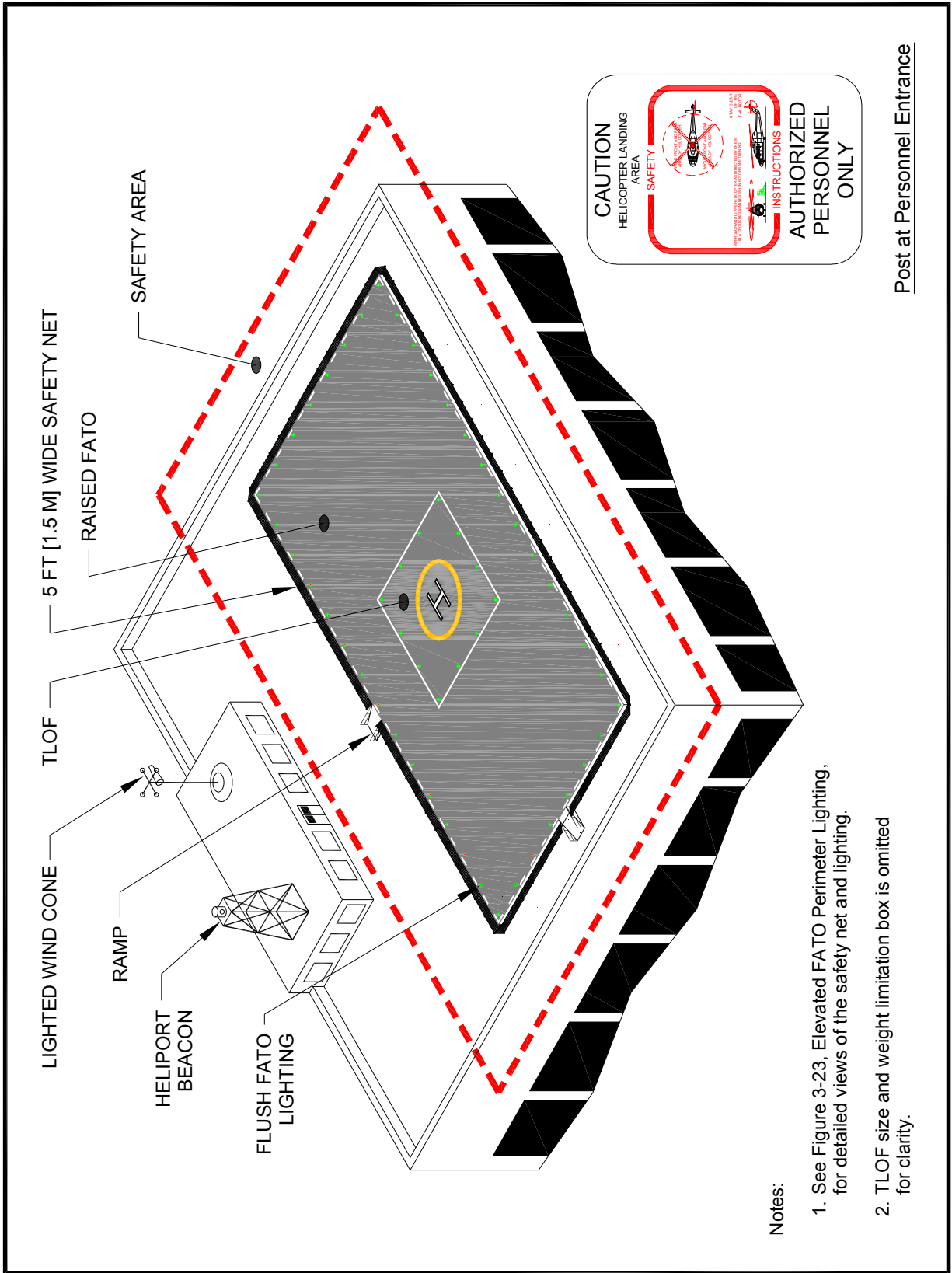
**f. TLOF gradients.** Recommended TLOF gradients are defined in Chapter 7.



**Figure 3–2. TLOF/FATO Safety Area Relationships and Minimum Dimensions: Transport**



**Figure 3–3. Elongated FATO with Two Takeoff Positions: Transport**



Notes:

1. See Figure 3-23, Elevated FATO Perimeter Lighting, for detailed views of the safety net and lighting.
2. TLOF size and weight limitation box is omitted for clarity.

Post at Personnel Entrance

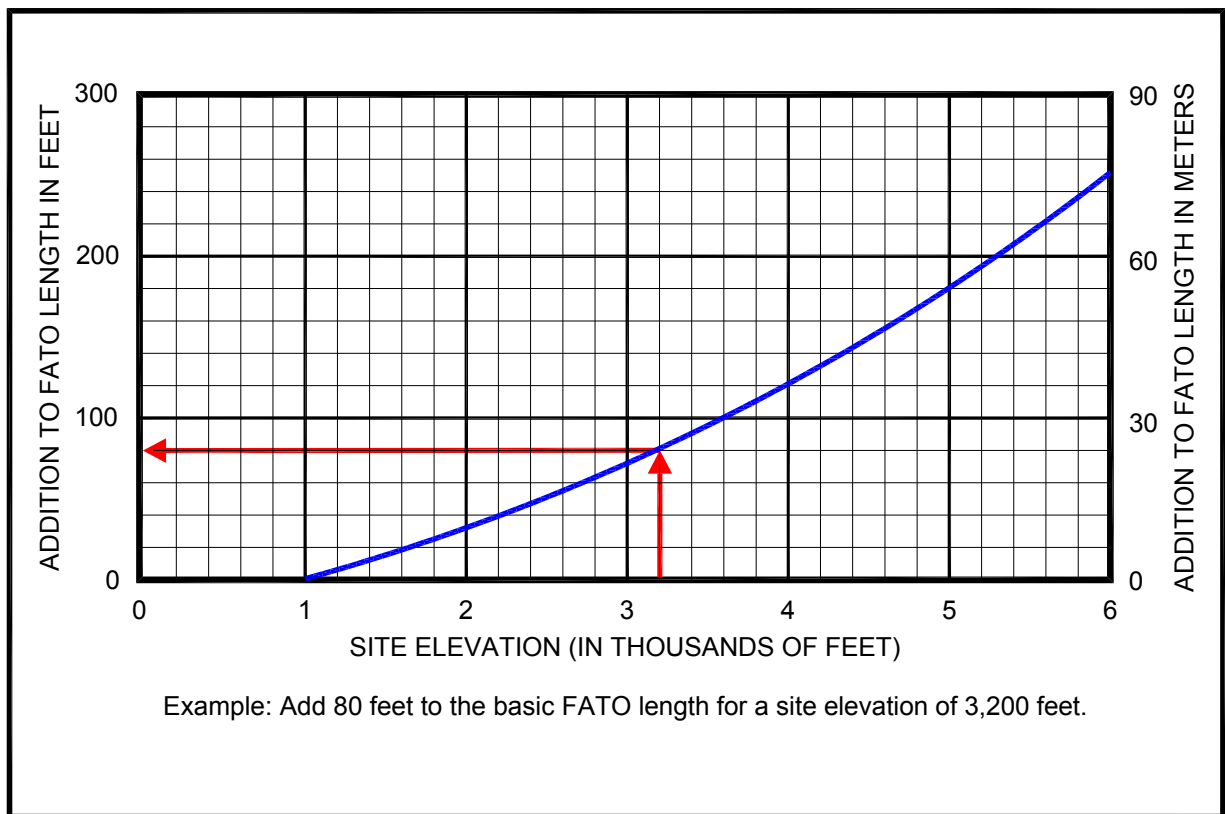
Figure 3-4. Elevated Heliport: Transport

**307. Final approach and takeoff area (FATO).** A transport heliport has at least one FATO. The FATO contains a TLOF within its borders at which arriving helicopters terminate their approach, and from which departing helicopters take off.

**a. FATO size.** The FATO is a rectangular surface with the long axis aligned with the preferred flight path. See Figure 3-2.

**(1) FATO width.** The minimum width of a FATO is at least 2.0 times the RD of the design helicopter but not less than 100 feet (30.5 m).

**(2) FATO length.** The minimum length of the FATO is 2.0 times the RD of the design helicopter but not less than 200 feet (61 m). At elevations above 1000 feet MSL, a longer FATO is required to provide an increased safety margin and greater operational flexibility. Use the additional FATO length depicted in Figure 3-5.



**Figure 3-5. Additional FATO Length for Heliports at Higher Elevations: Transport**

**(3)** Design the minimum distance between the TLOF perimeter and the FATO perimeter to be not less than  $\frac{3}{4} D - \frac{1}{2} RD$ , where D and RD are of the design helicopter.

**b. FATO surface characteristics.**

**(1)** Design the entire FATO to support the dynamic loads of the design helicopter.

**(2)** If the FATO surface is unpaved, treat it to prevent loose stones and any other flying debris caused by rotor wash.

**(3)** Design the portion of the FATO abutting the TLOF to be contiguous with the TLOF, with the adjoining edges at the same elevation.

**c. Rooftop and other elevated FATOs.**

**(1) Design loads.** Design elevated FATOs and any FATO supporting structure to be capable of supporting the dynamic loads of the design helicopter

**(2) Elevation.** Elevate the FATO above the level of any object in the safety area that cannot be removed.

**(3) Obstructions.** Elevator penthouses, cooling towers, exhaust vents, fresh air vents, and other raised features can affect heliport operations. Establish control mechanisms to ensure obstruction hazards are not installed after the heliport is operational.

**(4) Air quality.** Helicopter exhaust can affect building air quality if the heliport is too close to fresh air vents. When designing a building intended to support a helipad, locate fresh air vents accordingly. When adding a helipad to an existing building, relocate fresh air vents if necessary or, if relocation is not practical, installing charcoal filters or a fresh air intake bypass louver system for HVAC systems may be adequate.

**(5) FATO surface characteristics.** Construct rooftop and other elevated heliport FATOs of metal, concrete, or other materials subject to local building codes. Provide the FATO surface with non-slippery footing for people.

**(6) Safety net.** If the platform is elevated 4 feet (1.2 m) or more above its surroundings, Title 29 CFR Part 1910.23, Guarding Floor and Wall Openings and Holes, requires the provision of fall protection. The FAA recommends such protection for all platforms elevated 30 inches (76 cm) or more. However, do not use permanent railings or fences since they would be safety hazards during helicopter operations. As an option, install a safety net, meeting state and local regulations but not less than 5 feet (1.5 m) wide. Design the safety net to have a load-carrying capability of 50 lb/sq ft (244 kg/sq m). Do not allow the net, as illustrated in Figure 3–23, to project above the level of the FATO. Fasten both the inside and outside edges of the safety net to a solid structure. Construct nets of materials that are resistant to environmental effects.

**(7) Access to elevated FATOs.** Title 29 CFR Part 1926.34, Means of Egress, requires two separate access points for an elevated structure such as one supporting an elevated FATO. Design stairs in compliance with Title 29 CFR Part 1910.24, Fixed Industrial Stairs. Design handrails required by this standard to fold down or be removable to below the level of the FATO so they will not be hazards during helicopter operations.

**d. Mobile objects within the FATO.** The FATO design standards in this AC assume the TLOF and FATO are closed to other aircraft if a helicopter or other mobile object is within the FATO or the safety area.

**e. Fixed objects within the FATO.** Remove all fixed objects projecting above the FATO elevation except for lighting fixtures, which may project a maximum of 2 inches (5 cm). See Figure 7–3. For ground level heliports, remove all above-ground objects to the extent practicable.

**f. FATO/FATO separation.** If a heliport has more than one FATO, separate the perimeters of two FATOs so the respective safety areas do not overlap. This separation assumes simultaneous approach/departure operations will not take place. If the heliport operator intends for the facility to support simultaneous operations, provide a minimum 200 foot (61 m) separation.

**g. FATO gradients.** Recommended FATO gradients are defined in Chapter 7.

**308. Safety area.** The safety area surrounds the FATO.

**a. Safety area width.** The safety area extends outward on all sides of the FATO for a distance of at least  $\frac{1}{2}$  RD but not less than 30 feet (9 m).



**b. Mobile objects within the safety area.** The safety area design standards of this AC assume the TLOF and FATO are closed to other aircraft if a helicopter or other mobile object is within the FATO or the safety area.

**c. Fixed objects within a safety area.** Remove all fixed objects within a safety area projecting above the FATO elevation except for lighting fixtures, which may project a maximum of 2 inches (5 cm). See Figure 7–3. For ground level heliports, remove all above-ground objects to the extent practicable.

**d. Safety area surface.** The safety area need not be load bearing. Figure 3–6 depicts a safety area extending over water. If possible, make the portion of the safety area abutting the FATO contiguous with the FATO with the adjoining edges at the same elevation. This is needed to avoid the risk of catching a helicopter skid or wheel. Clear the safety area of flammable materials and treat the area to prevent loose stones and any other flying debris caused by rotor wash.

**e. Safety area gradients.** Safety area gradients are detailed in Chapter 7.

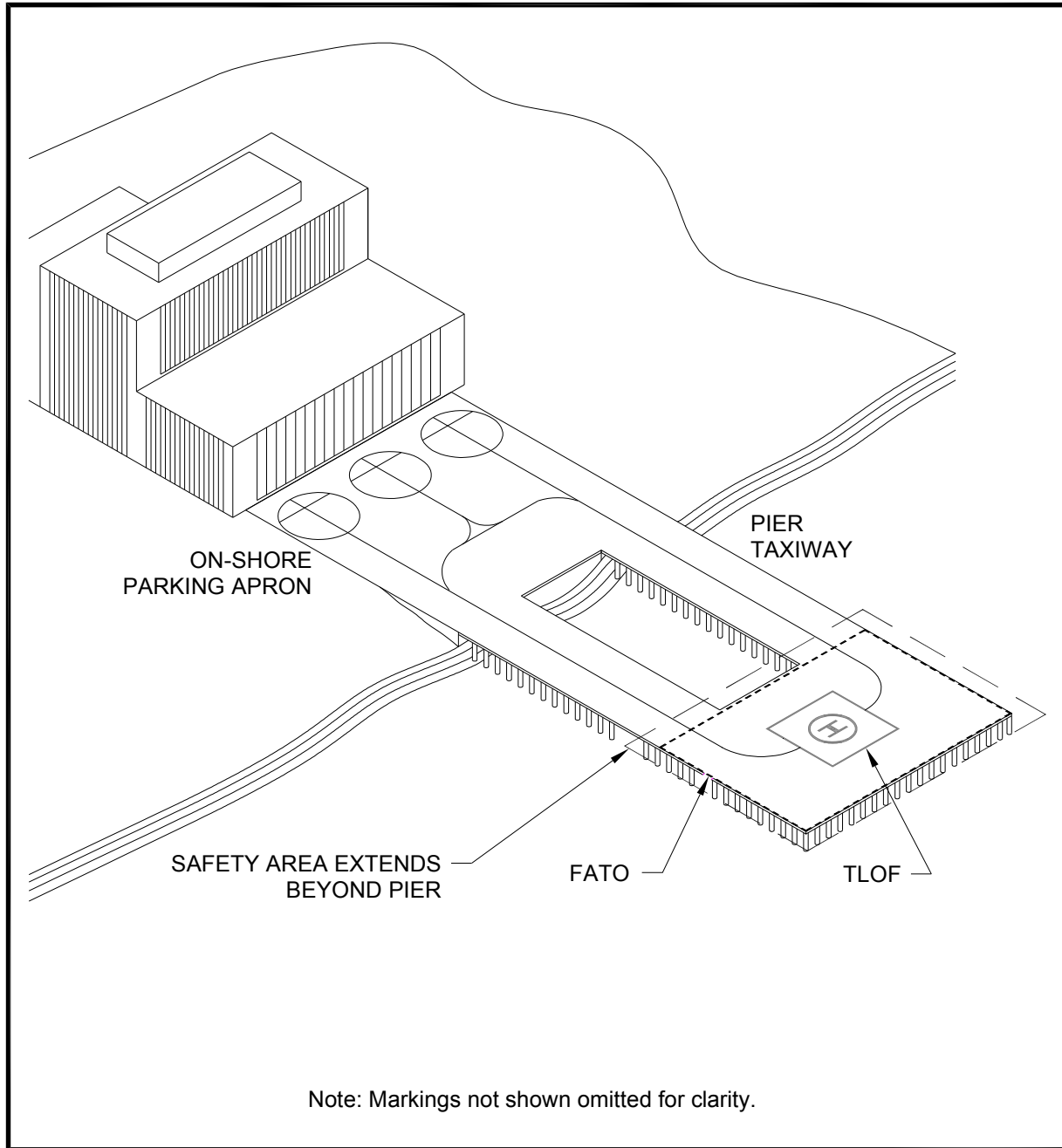
**309. VFR approach/departure paths.** The purpose of approach/departure airspace, shown in Figure 3–7 and Figure 3–8, is to provide sufficient airspace clear of hazards to allow safe approaches to and departures from the TLOF.

**a. Number of approach/departure paths.** Align preferred approach/departure paths with the predominant wind direction so downwind operations are avoided and crosswind operations are kept to a minimum. To accomplish this, design a transport heliport to have more than one approach/departure path. Base other approach/departure paths on the assessment of the prevailing winds or, when this information is not available, separate such flight paths and the preferred flight path by at least 135 degrees. See Figure 3–7.

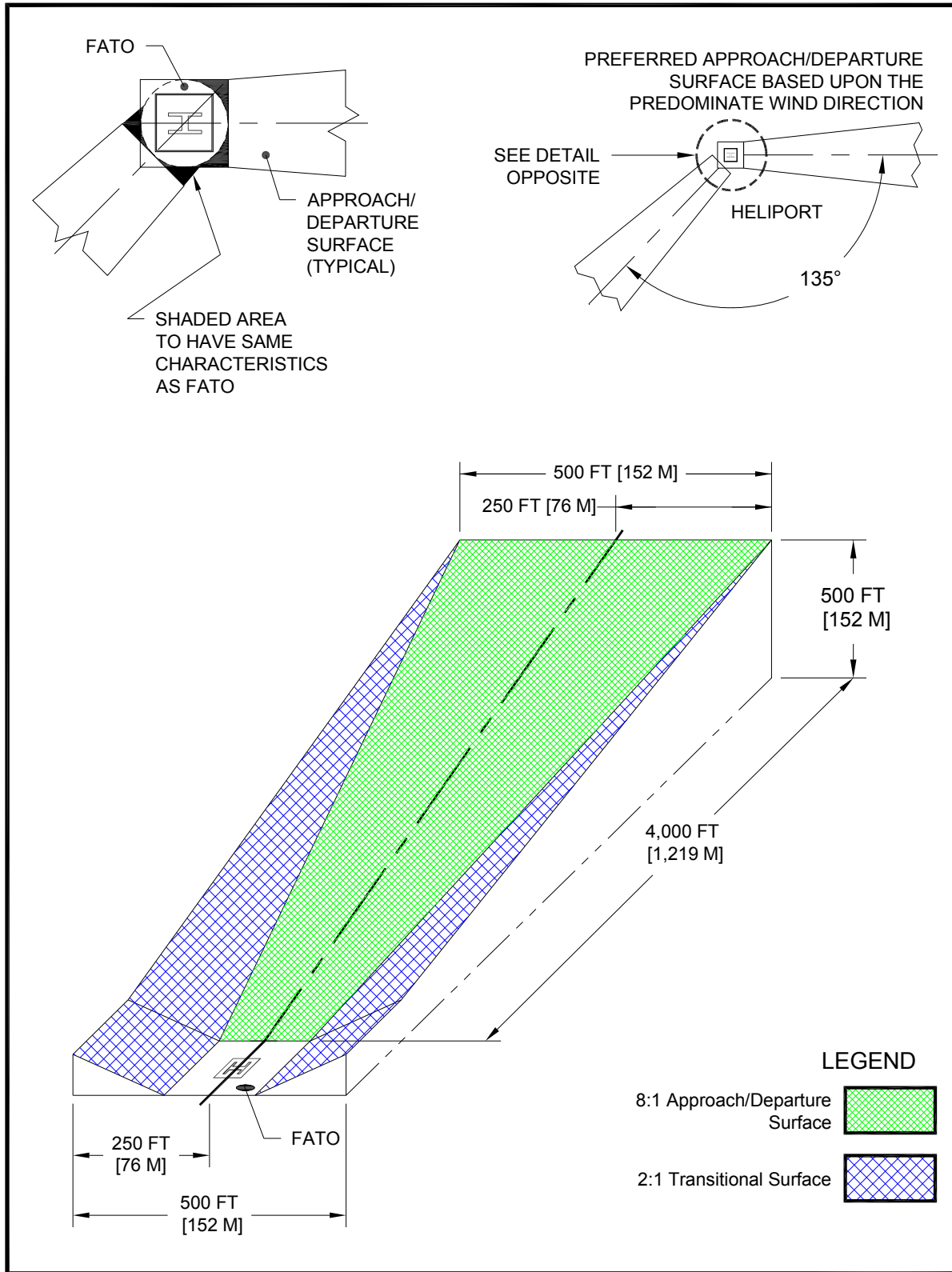
**b. VFR Approach/Departure and Transitional Surfaces.** Figure 3–7 and Figure 3–8 illustrate the approach/departure and transitional surfaces.

(1) An approach/departure surface is centered on each approach/departure path. The approach /departure path starts at the edge of the FATO and slopes upward at 8:1 (8 units horizontal in 1 unit vertical) for a distance of 4,000 feet (1,219 m) where the width is 500 feet (152 m) at a height of 500 feet (152 m) above the heliport elevation.

(2) The transitional surfaces start from the edges of the FATO parallel to the flight path center line, and from the outer edges of approach/departure surface, and extend outwards at a slope of 2:1 (2 units horizontal in 1 units vertical) for a distance of 250 feet (76 m) from the centerline. The transitional surfaces start at the edge of the FATO parallel to the approach/departure surfaces and extend to the end of the approach/departure surface. The transitional surface does not apply on the FATO edge opposite the approach/departure surface.



**Figure 3-6. Non-load-bearing Safety Area: Transport**



**Figure 3-7. VFR Heliport Approach/Departure and Transitional Surfaces: Transport**

(3) Make sure the approach/departure and transitional surfaces are free of penetrations unless an FAA aeronautical study determines such penetrations not to be hazards. The FAA conducts such aeronautical studies only at public heliports and private airports with FAA-approved approach procedures. Paragraph 111 provides additional information on hazards to air navigation.

**c. Curved VFR approach/departure paths.** As an option, include one curve in VFR approach/departure paths. As an option, design these paths to use the airspace above public lands, such as freeways or rivers. When including a curved portion in the approach/departure path, make sure the sum of the radius of arc defining the center line and the length of the straight portion originating at the FATO is not less than 1,886 feet (575 m). Design the approach/departure path so the minimum radius of the curve is 886 feet (270 m) and that the curve follows a 1,000 feet (305 m) straight section. Design the approach/departure path so the combined length of the center line of the curved portion and the straight portion is 4,000 feet (1,219 m). See Figure 3–8.

**d. Flight path alignment guidance.** As an option, use flight path alignment markings and/or flight path alignment lights (see paragraphs 301.d and 301.g) where it is desirable and practicable to indicate available approach and/or departure flight path direction(s). See Figure 3–9.

**e. Periodic review of obstructions.** Vigilant heliport operators reexamine obstacles in the vicinity of approach/departure paths on at least an annual basis. This reexamination includes an appraisal of the growth of trees near approach and departure paths. Paragraph 111 provides additional information on hazards to air navigation. Pay particular attention to obstacles that need to be marked or lighted. It may be helpful to maintain a list of the GPS coordinates and the peak elevation of obstacles.

**310. Heliport protection zone (HPZ).** The FAA recommends the establishment of an HPZ for each approach/departure surface. The HPZ is the area under the approach/departure surface starting at the FATO perimeter and extending out for a distance of 400 feet (122 m), as illustrated in Figure 3–10. The HPZ is intended to enhance the protection of people and property on the ground. This is achieved through heliport owner control over the HPZ. Such control includes clearing HPZ areas (and maintaining them clear) of incompatible objects and activities. The FAA discourages residences and places of public assembly in an HPZ. (Churches, schools, hospitals, office buildings, shopping centers, and other uses with similar concentrations of persons typify places of public assembly.) Do not locate hazardous materials, including fuel, in the HPZ.

**311. Wind cone.**

**a. Specification.** Use a wind cone conforming to AC 150/5345-27, Specification for Wind Cone Assemblies, to show the direction and magnitude of the wind. Use a color that provides the best possible color contrast to its background.

**b. Wind cone location.** Locate the wind cone so it provides the pilot with valid wind direction and speed information in the vicinity of the heliport under all wind conditions.

(1) At many landing sites, there may be no single, ideal location for the wind cone. At other sites, it may not be possible to site a wind cone at the ideal location. In such cases, install more than one wind cone in order to provide the pilot with all the wind information needed for safe operations.

(2) Place the wind cone so a pilot on the approach path can see it clearly when the helicopter is 500 feet (150 m) from the TLOF.

(3) Place the wind cone so pilots can see it from the TLOF.

(4) To avoid presenting an obstruction hazard, locate the wind cone(s) outside the safety area, and so it does not penetrate the approach/departure or transitional surfaces.

**c. Wind cone lighting.** For night operations, illuminate the wind cone, either internally or externally, to ensure it is clearly visible.

**312. Taxiways and taxi routes.** Taxiways and taxi routes provide for the movement of helicopters from one part of a landing facility to another. They provide a connecting path between the FATO and a parking area. They also provide a maneuvering aisle within the parking area. A taxi route includes the taxiway plus the appropriate clearances needed on both sides. The relationship between a taxiway and a taxi route is illustrated in Figure 3–11.

**a. Taxiway/taxi route widths.** The dimensions of taxiways and taxi routes are a function of helicopter size and type of taxi operations (ground taxi or hover taxi). Find these dimensions in Table 3-1. Normally, the requirement for hover taxi dictates the taxiway/taxi route widths. However, when the fleet comprises a combination of large ground taxiing helicopters and smaller air taxiing helicopters, the larger aircraft may dictate the taxiway/taxi route widths. If wheel-equipped helicopters taxi with wheels not touching the surface, design the facility with hover taxiway widths rather than ground taxiway widths. Where the visibility of the centerline marking cannot be guaranteed at all times, such as locations where snow or dust commonly obscure the centerline marking and it is not practical to remove it, determine the minimum taxiway/taxi route dimensions as if there was no centerline marking.

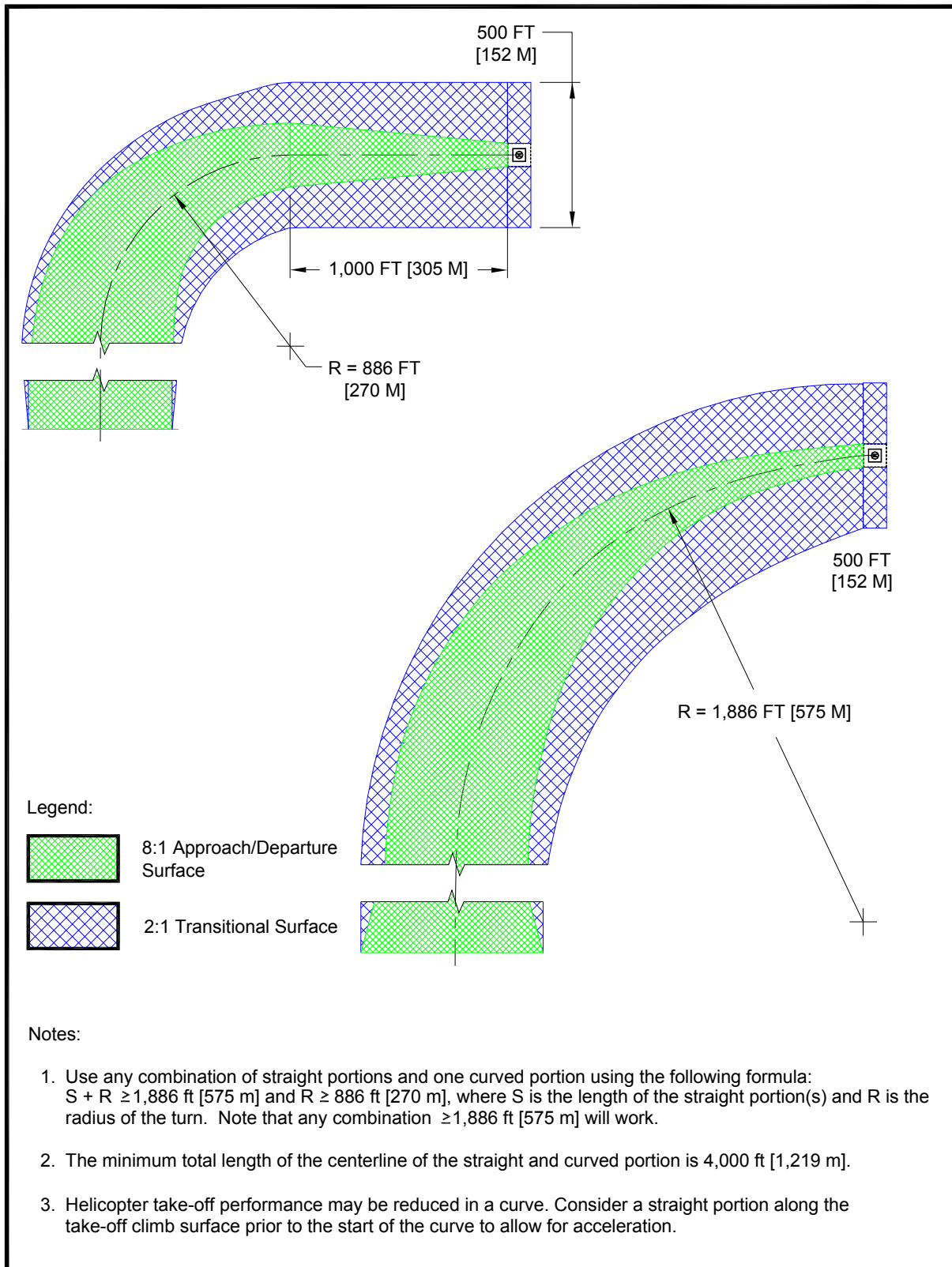
**b. Surfaces.** For ground taxiways, provide a portland cement concrete or asphalt surface. For unpaved portions of taxi routes, provide a turf cover or treat the ground in some way to prevent dirt and debris from being raised by a taxiing helicopter’s rotor wash.

**c. Gradients.** See Chapter 7 for taxiway and taxi route gradient standards.

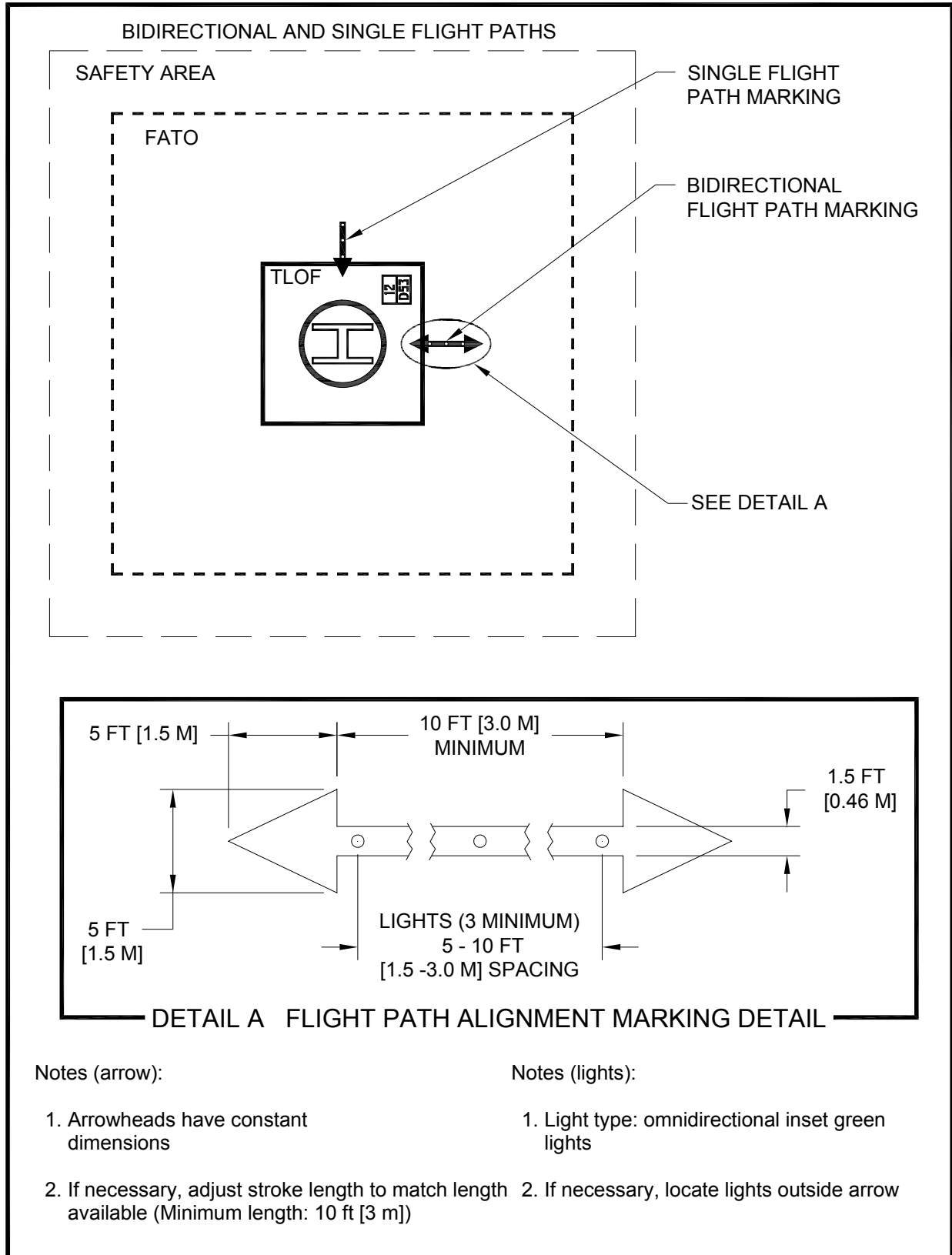
**313. Helicopter parking.** A transport heliport has a paved apron for parking helicopters. The size of the apron depends on the number and size of specific helicopters to be accommodated. It is not necessary that every parking position accommodate the design helicopter. Design individual parking positions to accommodate the helicopter size and weight expected to use the parking position at the facility. However, use the design helicopter to determine the separation between parking positions and taxi routes. Use the larger helicopter to determine the separation between parking positions intended for helicopters of different sizes. Design parking positions to support the static loads of the helicopter intended to use the parking area. Ground taxi turns of wheeled helicopters are significantly larger than a hover turn. Consider the turn radius of helicopters when designing taxi intersections and parking positions for wheeled helicopters. Design heliport parking areas so helicopters will be parked in an orientation that keeps the “avoid areas” around the tail rotors (see Figure 3–12) clear of passenger walkways. Establish separate aprons for specific functions such as passenger boarding, maintenance, and parking of based and transient helicopters.

**Table 3-1. Taxiway and Taxi Route Dimensions – Transport Heliports**

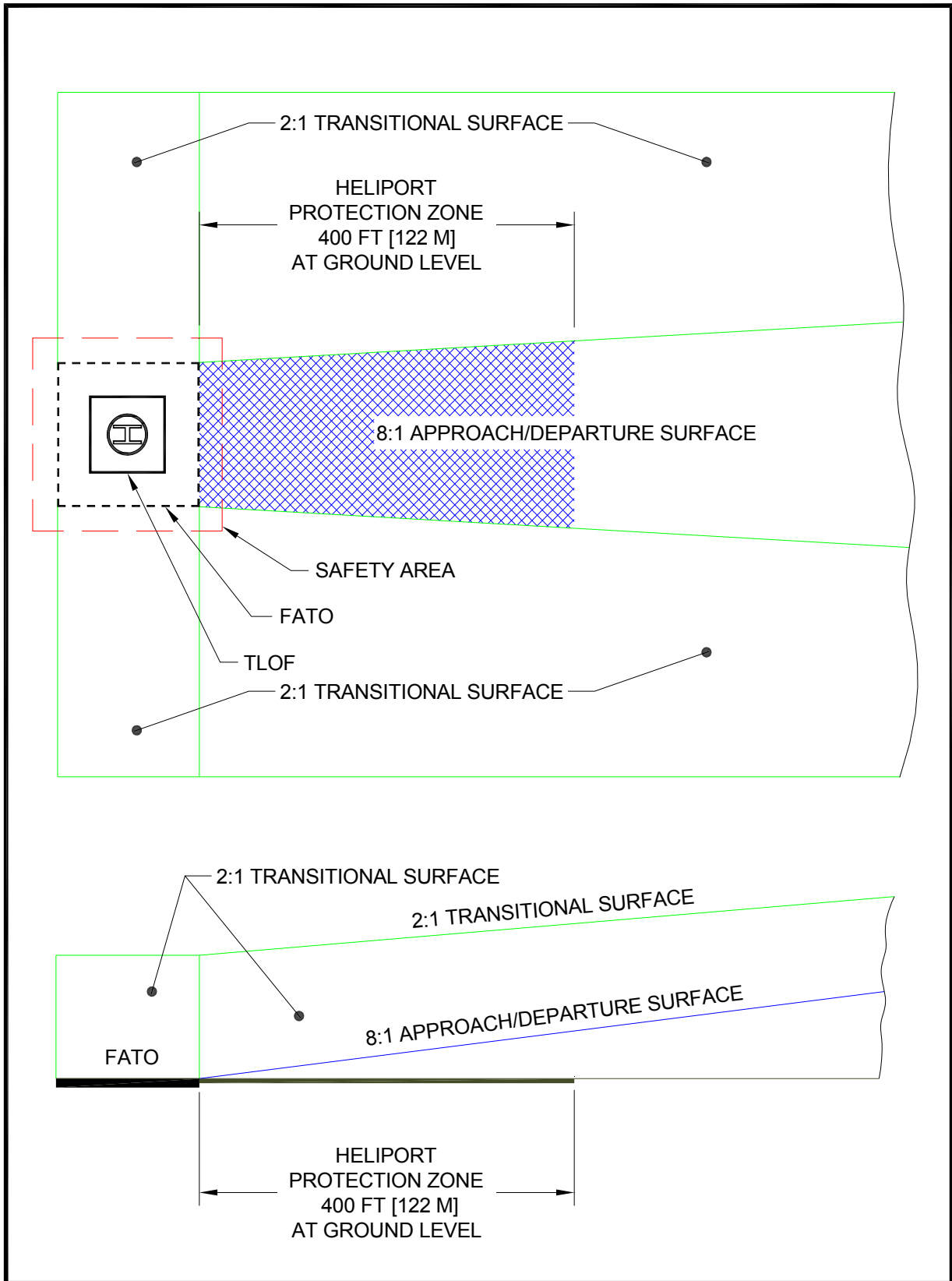
Taxiway (TW)	Centerline Marking Type	TW Edge Marking Type	Minimum Width of Paved Area	Lateral Separation Between TW Edge Markings	Total Taxi Route Width
Ground Taxiway	Painted	Painted	2 x UC	2 x UC	1½ RD
Hover Taxi	Painted	Painted	2 x UC	2 x UC	2 RD
RD: rotor diameter of the design helicopter TW: taxiway UC: undercarriage length or width (whichever is larger) of the design helicopter					



**Figure 3–8. Curved Approach/Departure: Transport**

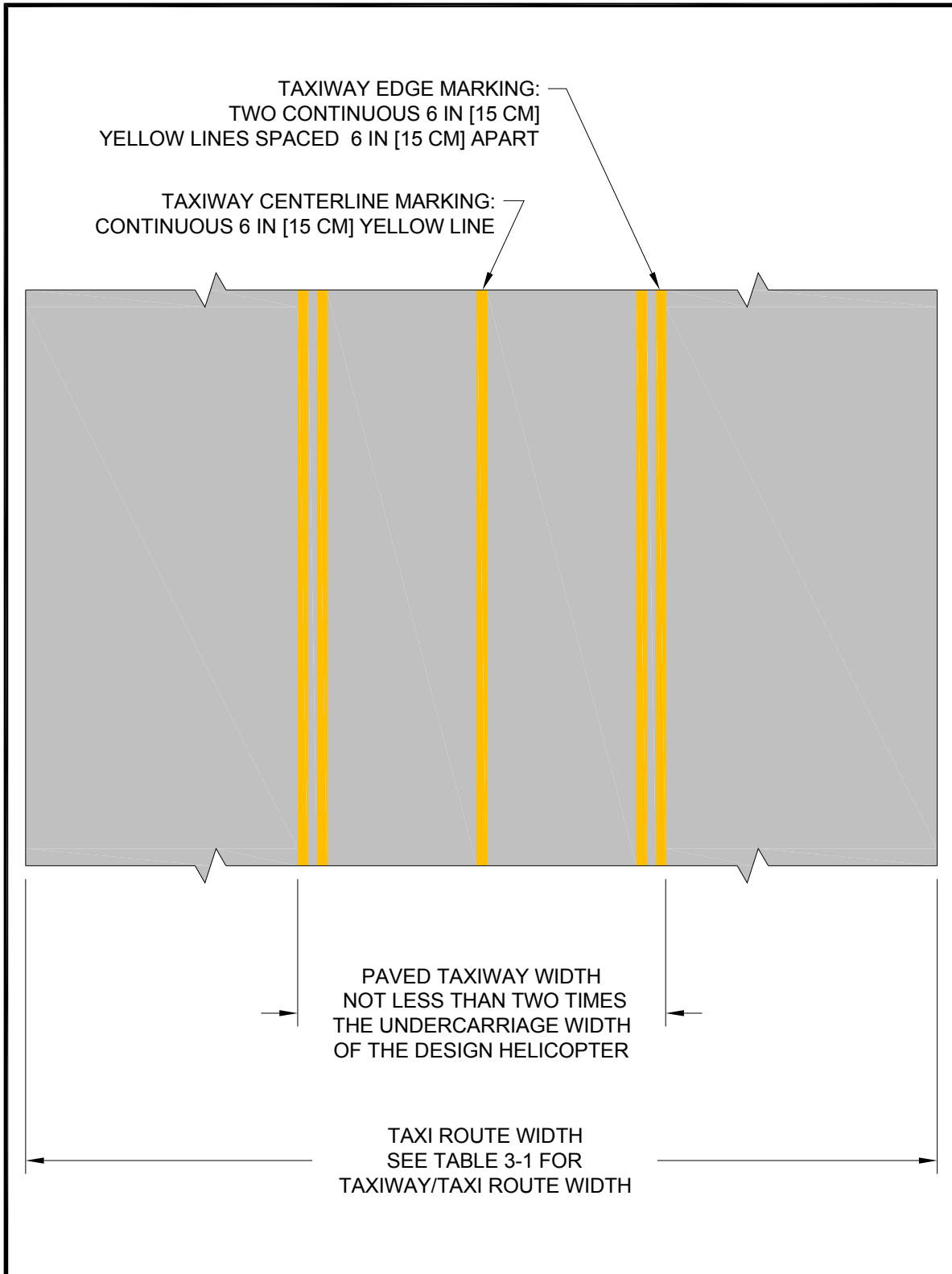


**Figure 3-9. Flight Path Alignment Marking and Lights: Transport**

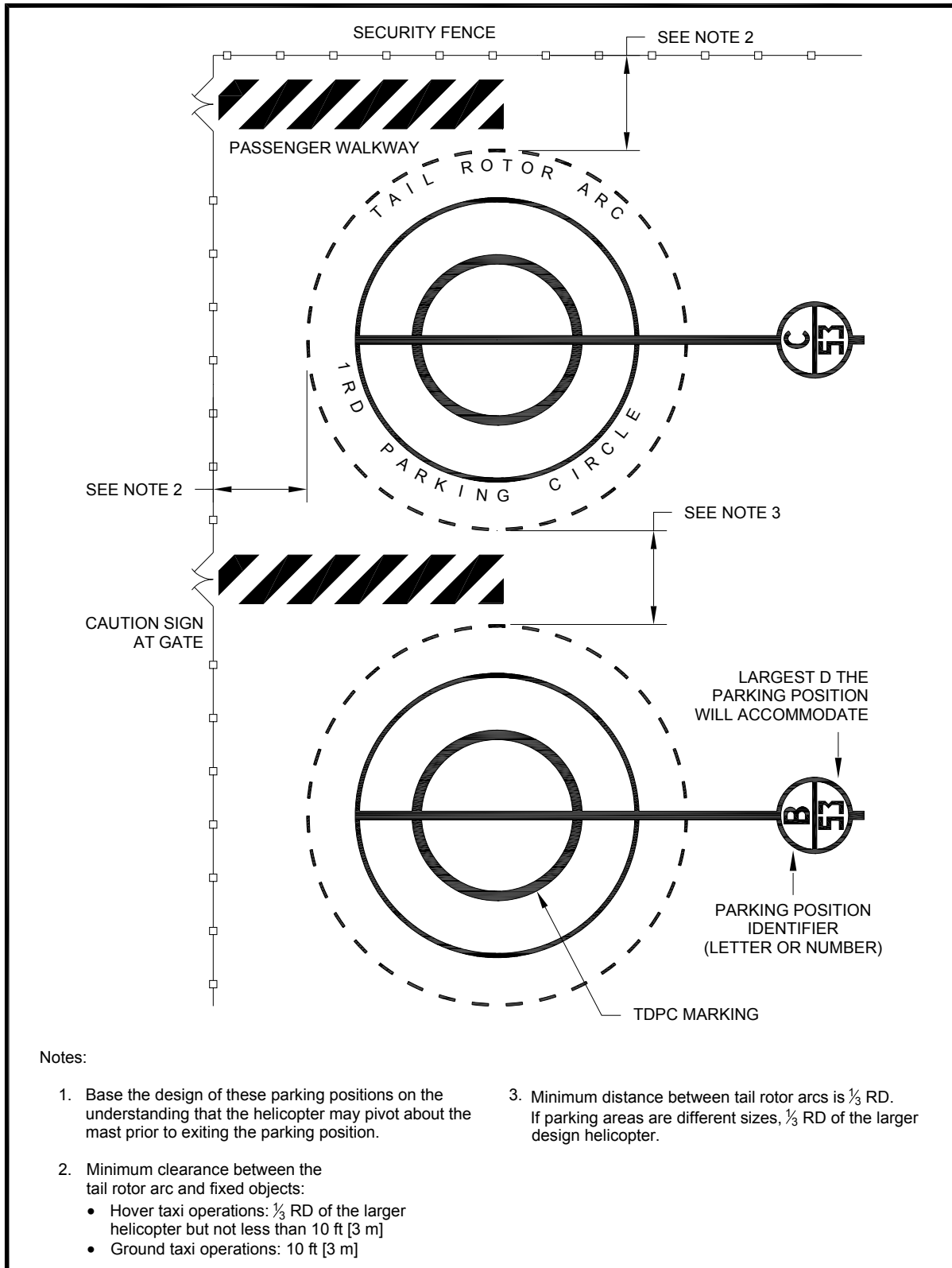


**Figure 3-10. Heliport Protection Zone: Transport**





**Figure 3–11. Taxiway/Taxi Route Relationship, Centerline and Edge Marking: Transport**



**Figure 3–12. “Turn-around” Helicopter Parking Position Marking: Transport**

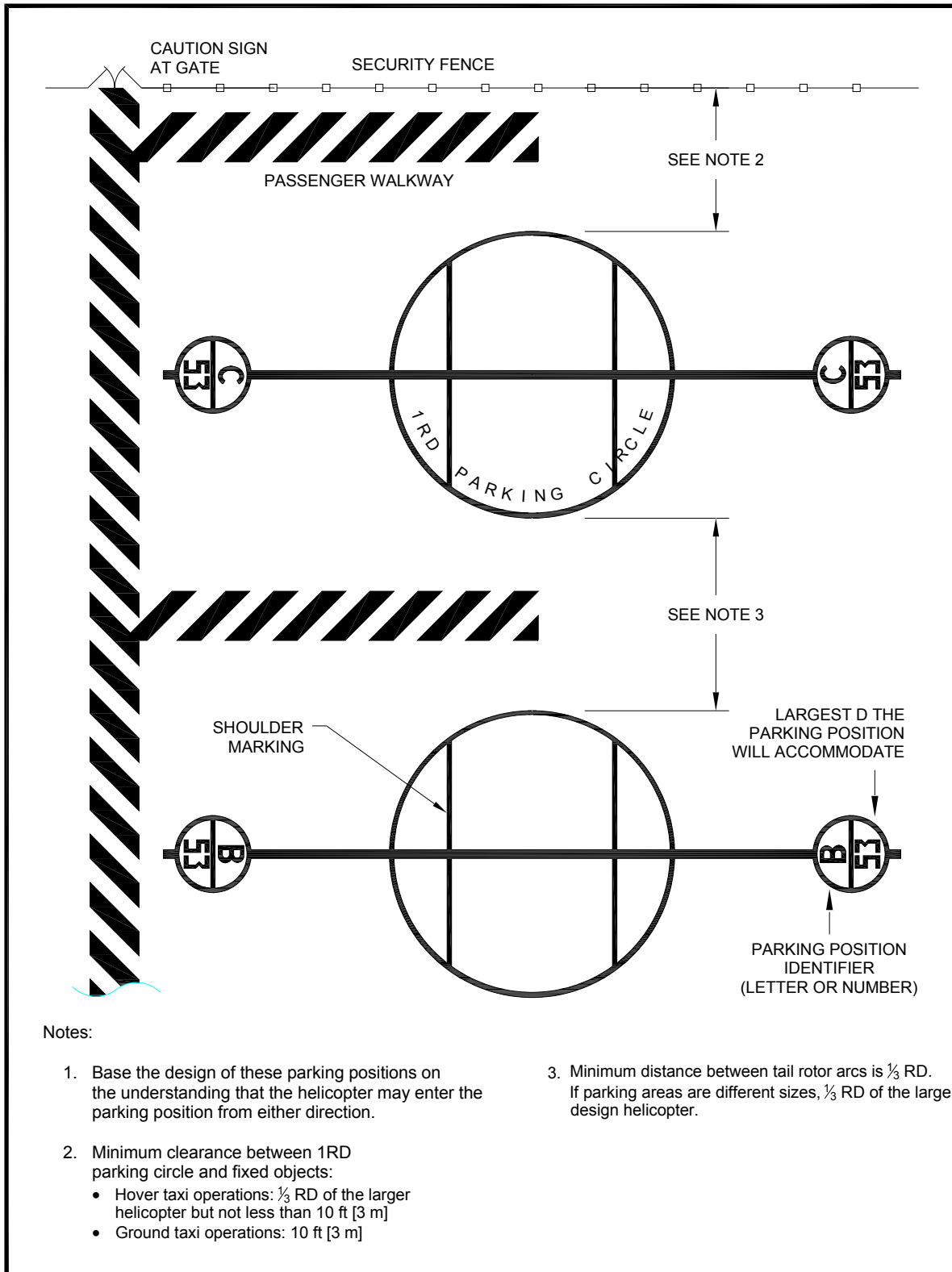


Figure 3-13. “Taxi-through” Helicopter Parking Position Marking: Transport

**a. Location.** Do not locate aircraft parking areas under an approach/departure surface. As an option, allow aircraft parking areas under the transitional surfaces.

(1) For “turn around” parking positions, locate the parking position to provide a minimum distance between the tail rotor arc and any object, building, or safety area. The standard for this distance is 10 feet (3 m) for ground taxi operations and the greater of 10 feet (3 m) or  $\frac{1}{3}$  RD for hover taxi operations. See Figure 3–12 and Figure 3–14.

(2) For “taxi-through” parking positions, locate the parking position to provide a minimum distance between the main rotor circle and any object, building, or safety area. The standard for this distance is 10 feet (3 m) for ground taxi operations and the greater of 10 feet (3 m) or  $\frac{1}{3}$  RD for hover taxi operations. See Figure 3–13 and Figure 3–15.

(3) Locate the parking position to provide a minimum distance between the tail rotor arc and the edge of any taxi route. The standard for this distance is  $\frac{1}{2}$  RD but not less than 30 feet (9.1 m).

**b. Size.** Parking position sizes are dependent upon the helicopter size. The clearances between parking positions are dependent upon the type of taxi operations (ground-taxi or hover/ taxi) and the intended paths for maneuvering in and out of the parking position. The more demanding operation will dictate what is needed at a particular site. Usually, the parking area needs for skid-equipped helicopters will be the most demanding. However, when the largest helicopter is a very large, wheeled aircraft (for example, the S-61), and the skid-equipped helicopters are all much smaller, the parking size needs for wheeled helicopters may be the most demanding. If wheel-equipped helicopters taxi with wheels not touching the surface, design parking areas based on hover taxi operations rather than ground taxi operations.

(1) If all parking positions are the same size, design them to be large enough to accommodate the largest helicopter that will operate at the heliport.

(2) As an option when there is more than one parking position, design the facility with parking positions of various sizes with at least one position that will accommodate the largest helicopter that will park at the heliport. Design other parking positions to be smaller, for the size of the individual or range of individual helicopters parking at that position.

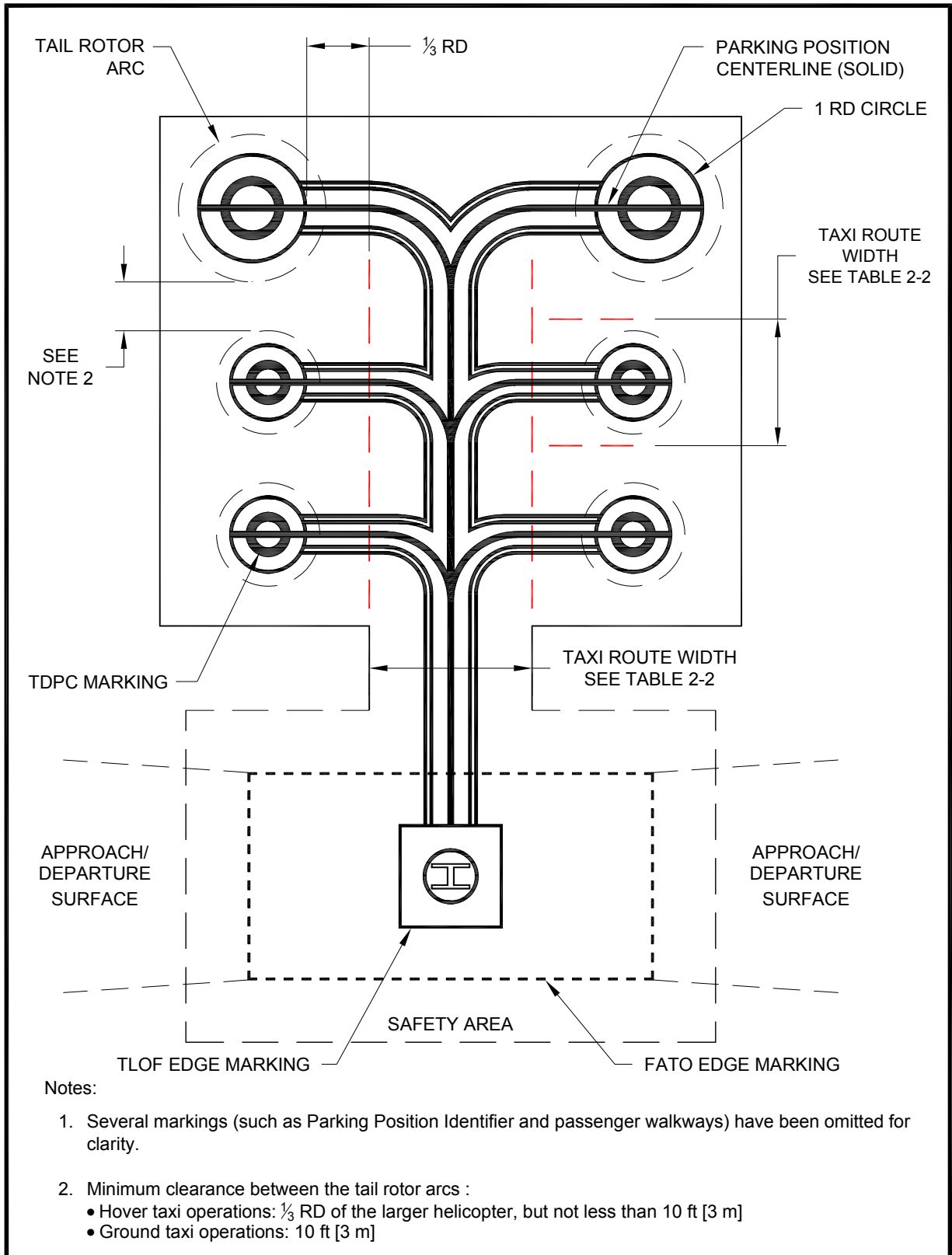
(3) “Turn-around” parking positions are illustrated in Figure 3–14.

(4) “Taxi-through” parking positions are illustrated in Figure 3–15. When using this design for parking positions, the heliport owner and operator take steps to ensure all pilots are informed that “turn-around” departures from the parking position are not permitted.

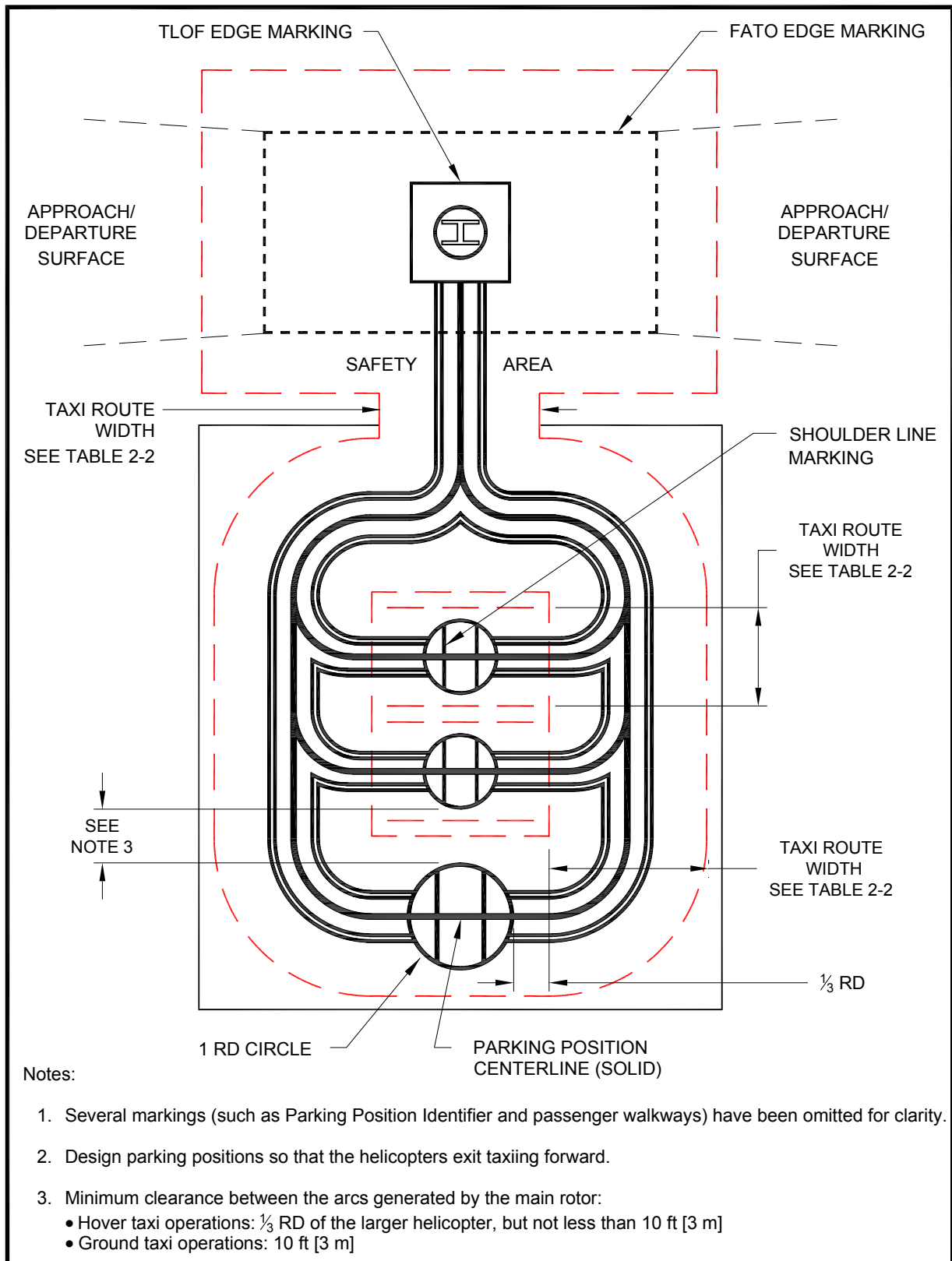
(5) Do not design “back-out” parking positions at transport heliports.

**c. Passenger walkways.** Provide marked walkways at parking positions. Locate passenger walkways to minimize passenger exposure to various risks during passenger loading and unloading. Design the pavement so spilled fuel does not drain onto passenger walkways or toward parked helicopters.

**d. Fueling.** Design the facility to allow fueling with the use of a fuel truck or a specific fueling area with stationary fuel tanks.



**Figure 3-14. Parking Area Design – “Turn-around” Parking Positions: Transport**



**Figure 3–15. Parking Area Design – “Taxi-through” Parking Position**

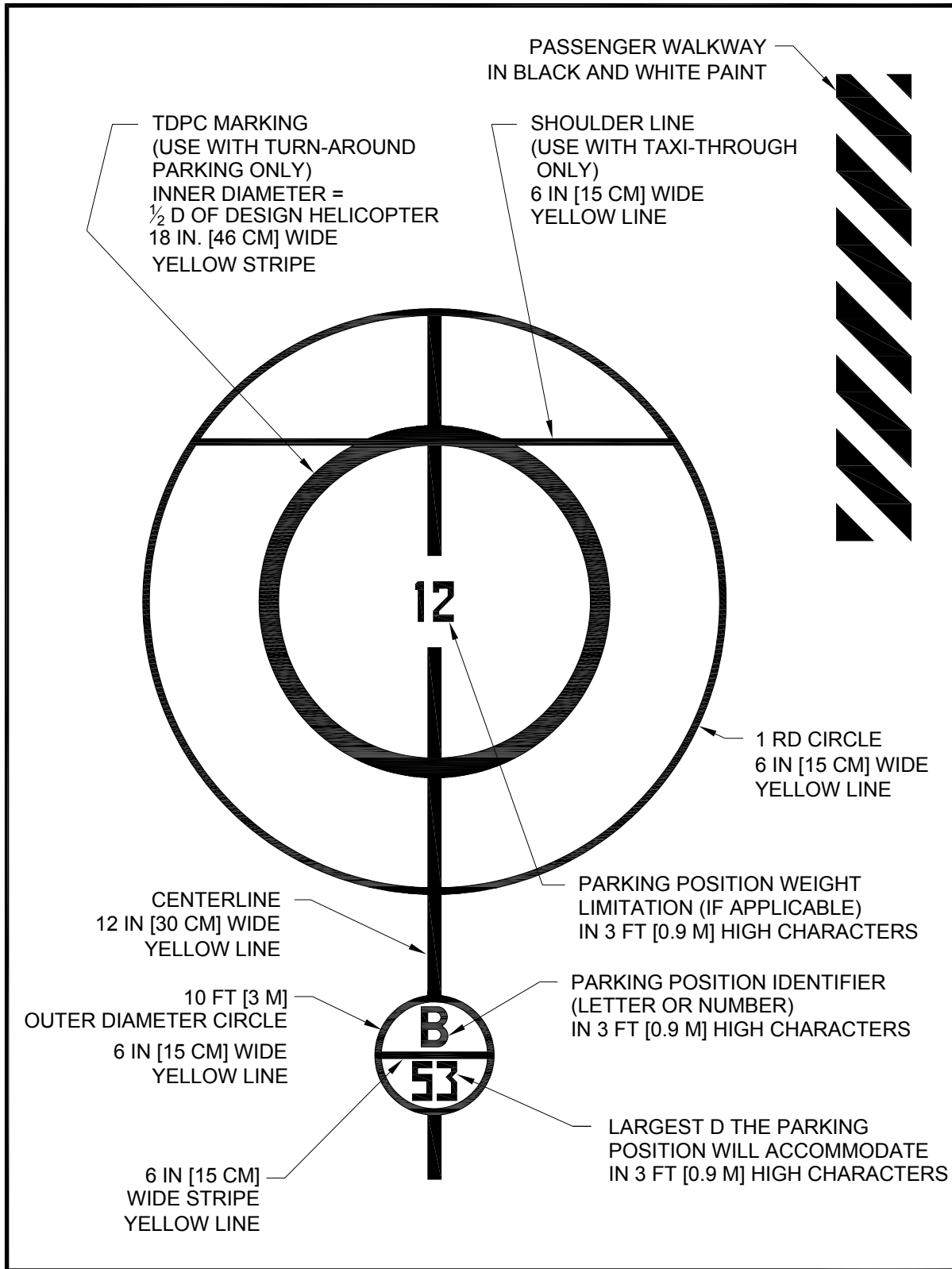


Figure 3-16. Parking Position Identification, Size and Weight Limitations: Transport

(1) Various federal, state, and local requirements for petroleum handling facilities apply to systems for storing and dispensing fuel. Find guidance in AC 150/5230-4, Aircraft Fuel Storage, Handling, and Dispensing on Airports. Find additional information in various National Fire Protection Association (NFPA) publications. For a list of more resources, see Appendix D.

(2) Do not locate fueling equipment in the TLOF, FATO, or safety area. Design separate fueling locations and mark them to minimize the potential for helicopters to collide with the dispensing equipment. Design fueling areas so there is no object tall enough to be hit by the main or tail rotor blades within a distance of RD of the design helicopter from the center point of the position where the helicopter is fueled (providing  $\frac{1}{2}$  RD clearance from the rotor tips). If this is not practical at an existing facility, install long fuel hoses.

(3) Lighting. Light the fueling area if night fueling operations are contemplated. Ensure any light poles do not constitute an obstruction hazard.

e. **Tiedowns.** Install recessed tiedowns to accommodate extended or overnight parking of based or transient helicopters. Ensure any depression associated with the tiedowns is of a diameter not greater than one-half the width of the smallest helicopter landing wheel or landing skid anticipated to be operated on the heliport surface. In addition, provide storage for tiedown chocks, chains, cables, and ropes off the heliport surface to avoid fouling landing gear. Find guidance on tiedowns in AC 20-35, Tiedown Sense.

**314. Heliport markers and markings.** Markers and/or surface markings identify the facility as a heliport. Use surface markings of paint or preformed material. (See AC 150/5370-10, Item P-620, for specifications for paint and preformed material). As an option, use reflective paint and reflective markers, though remember overuse of reflective material can be blinding to a pilot using landing lights. As an option, outline lines/markings with a 6-inch (15 cm) wide line of a contrasting color to enhance conspicuity. Place markings that define the edges of a TLOF, FATO, taxiway or apron within the limits of those areas. Use the following markers and markings.

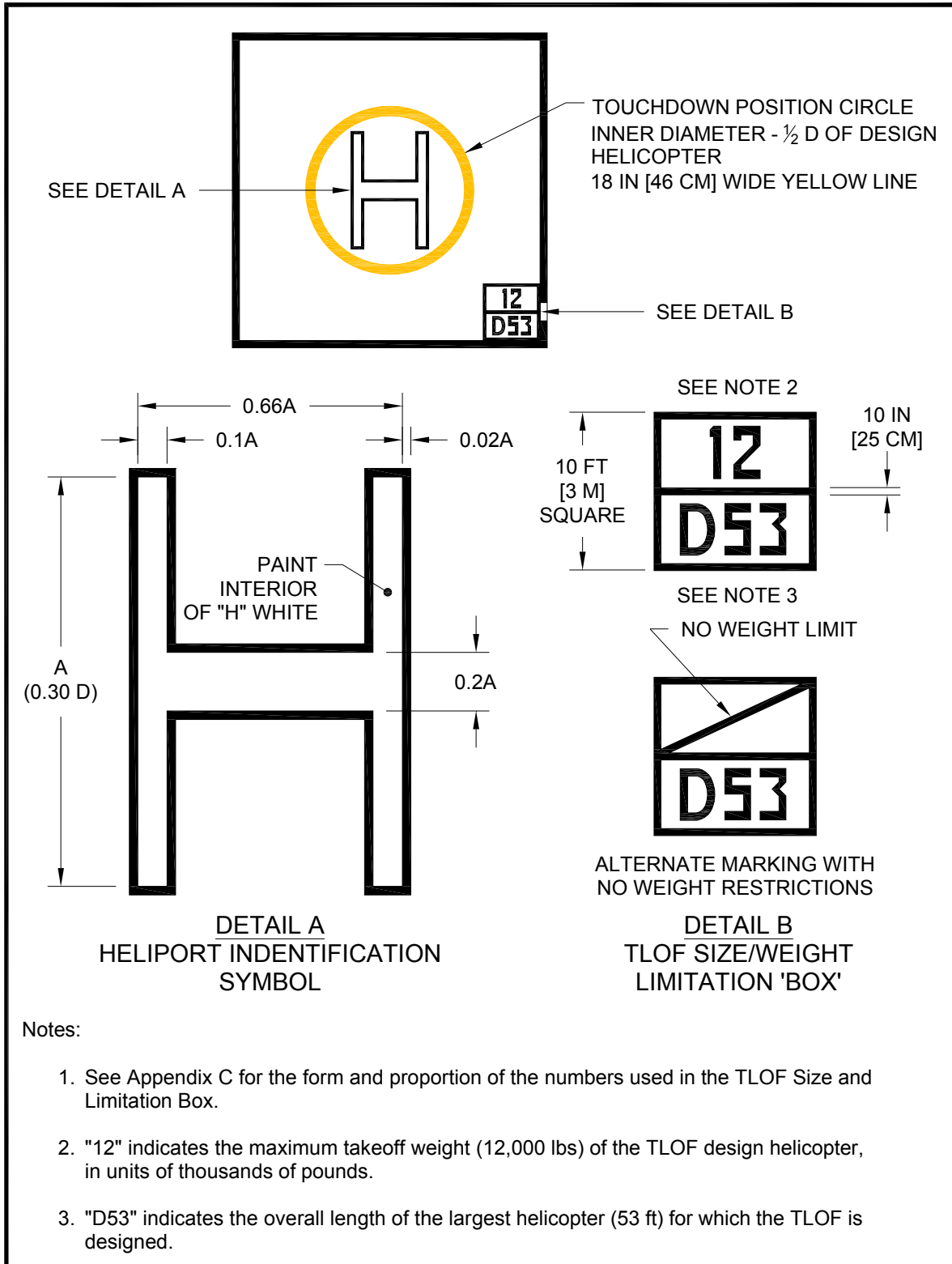
a. **Heliport identification marking.** The identification marking identifies the location as a heliport, marks the TLOF and provides visual cues to the pilot. The marking consists of a white "H." The "H" has a minimum height of 0.3 D. Locate the "H" in the center of the TLOF and orient it on the axis of the preferred approach/departure path. Place a one-foot wide bar under the "H" when it is necessary to distinguish the preferred approach/departure direction. The proportions and layout of the letter "H" are illustrated in Figure 3-17.

**b. TLOF markings.**

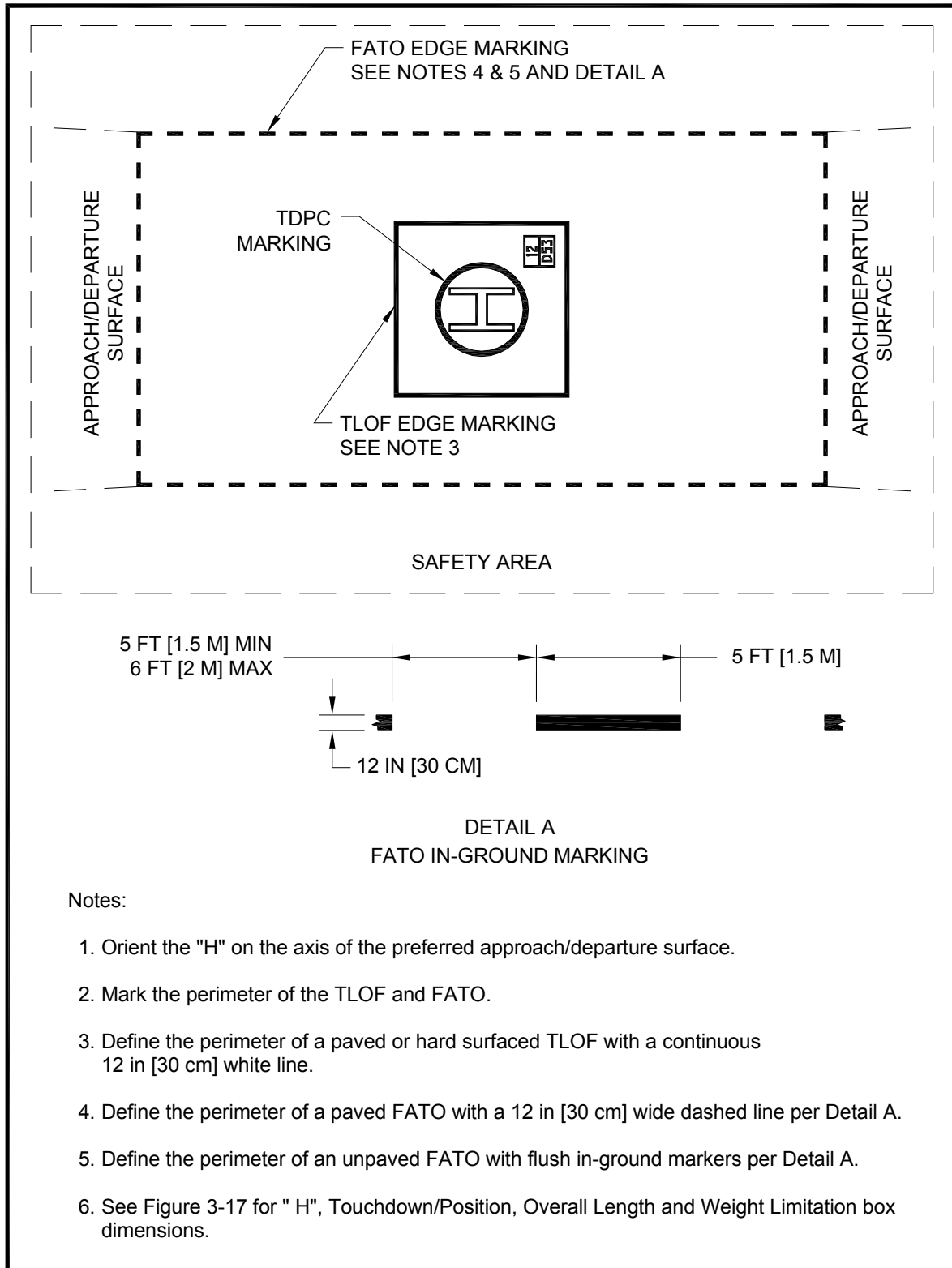
(1) **TLOF perimeter marking.** Define the perimeter of a TLOF with a continuous 12-inch (30 cm) wide, white line, as shown in Figure 3-18.

(2) **Touchdown/positioning circle (TDPC) marking.** A TDPC marking provides guidance to allow a pilot to touch down in a specific position on paved surfaces. When the pilot's seat is over the marking, the undercarriage will be inside the LBA, and all parts of the helicopter will be clear of any obstacle by a safe margin. A TDPC marking is a yellow circle with an inner diameter of  $\frac{1}{2}$  D and a line width of 18 in (46 cm). Locate a TDPC marking in the center of a TLOF. See Figure 3-17.





**Figure 3-17. Standard Heliport Identification Symbol, TLOF Size and Weight Limitations: Transport**



**Figure 3–18. Paved TLOF/Paved FATO –  
Paved TLOF/Unpaved FATO – Marking: Transport**

**(3) TLOF size and weight limitations.** Mark the TLOF to indicate the length and weight of the largest helicopter it will accommodate, as shown in Figure 3–17. Place these markings in a box in the lower right-hand corner of the TLOF, or the on right-hand side of the “H” of a circular TLOF, when viewed from the preferred approach direction. The box is 10 feet square (3 m). The numbers are 36” (92 cm) high (see Figure C–2). The numbers are black with a white background.

**(4) TLOF size limitation.** This number is the length (D) of the largest helicopter the TLOF will accommodate, as shown in Figure 3–17. The marking consists of the letter “D” followed by the dimension in feet. Do not use metric equivalents for this purpose. Center this marking in the lower section of the TLOF size/weight limitation box.

**(5) TLOF weight limitations.** If a TLOF has limited weight-carrying capability, mark it with the maximum takeoff weight of the design helicopter, in units of thousands of pounds, as shown in Figure 3–17. Do not use metric equivalents for this purpose. Center this marking in the upper section of a TLOF size/weight limitation box. If the TLOF does not have a weight limit, add a diagonal line, extending from the lower left hand corner to the upper right hand corner, to the upper section of the TLOF size/weight limitation box.

**c. FATO markings.**

**(1) FATO perimeter marking.**

**(a) Paved FATOs.** Define the perimeter of a paved FATO with a 12-inch (30 cm) wide dashed white line. Define the corners of the FATO. The marking segments are approximately 5 feet (1.5 m) in length, and with end-to-end spacing of approximately 5 feet (1.5 m). See Figure 3–18.

**(b) Unpaved FATOs.** Mark the perimeter of an unpaved FATO with 12-inch (30 cm) wide, flush in-ground markers. Define the corners of the FATO. They are approximately 5 feet (1.5 m) in length, and with end-to-end spacing of approximately 5 feet (1.5 m). See Figure 3–18.

**d. Flight path alignment guidance marking.** An optional flight path alignment guidance marking consists of one or more arrows to indicate the preferred approach/departure direction(s). Place it on the TLOF, FATO and/or safety area surface as shown in Figure 3–9. The shaft of the arrow is 18 inches (50 cm) in width and at least 10 feet (3 m) in length. When combined with a flight path alignment guidance lighting system described in paragraph 301.g, it takes the form shown in Figure 3–9, which includes scheme for marking the arrowheads. Use a color that provides good contrast against the background color of the surface. An arrow pointing toward the center of the TLOF depicts an approach direction. An arrow pointing away from the center of the TLOF depicts a departure direction. In the case of a flight path limited to a single departure path, the arrow marking is unidirectional. In the case of a heliport with only a bidirectional approach /takeoff flight path available, the arrow marking is bidirectional.

**e. Taxiway and taxi route markings.**

**(1) Taxiway markings.** Mark the centerline of a taxiway with a continuous 6-inch (15 cm) yellow line. Mark both edges of the taxiway with two continuous 6-inch (15 cm) wide yellow lines spaced 6 inches (15 cm) apart. Figure 3–11 illustrates taxiway centerline and edge markings.

**(2) Taxiway to parking position transition requirements.** For paved taxiways and parking areas, taxiway centerline markings continue into parking positions and become the parking position centerlines.

**f. Helicopter parking position markings.** Helicopter parking positions have the following markings.

**(1) Paved parking position identifications.** Mark parking position identifications (numbers or letters) if there is more than one parking position. These markings are yellow characters 36 inches (91 cm) high. See Figure 3–16 and Figure C–1.

**(2) Rotor diameter circle.** Define the circle of the RD of the largest helicopter that will park at that position with a 6-inch (15 cm) wide, solid yellow line with an outside diameter of RD. See Figure 3–12.

**(3) Touchdown/positioning circle (TDPC) marking.** An optional TDPC marking provides guidance to allow a pilot to touch down in a specific position on paved surfaces. When the pilot's seat is over the marking, the undercarriage will be inside the LBA, and all parts of the helicopter will be clear of any obstacle by a safe margin. A TDPC marking is a yellow circle with an inner diameter of  $\frac{1}{2}$  D and a line width of 18 in (46 cm). Locate a TDPC marking in the center of a parking area. See Figure 3–16. The FAA recommends a TDPC marking for "turn-around" parking areas.

**(4) Maximum length marking.** This marking on paved surfaces indicates the D of the largest helicopter that the position will accommodate (for example, 49). This marking is in yellow characters at least 36 inches (91 cm) high. See Figure 3–17 and Figure C–1.

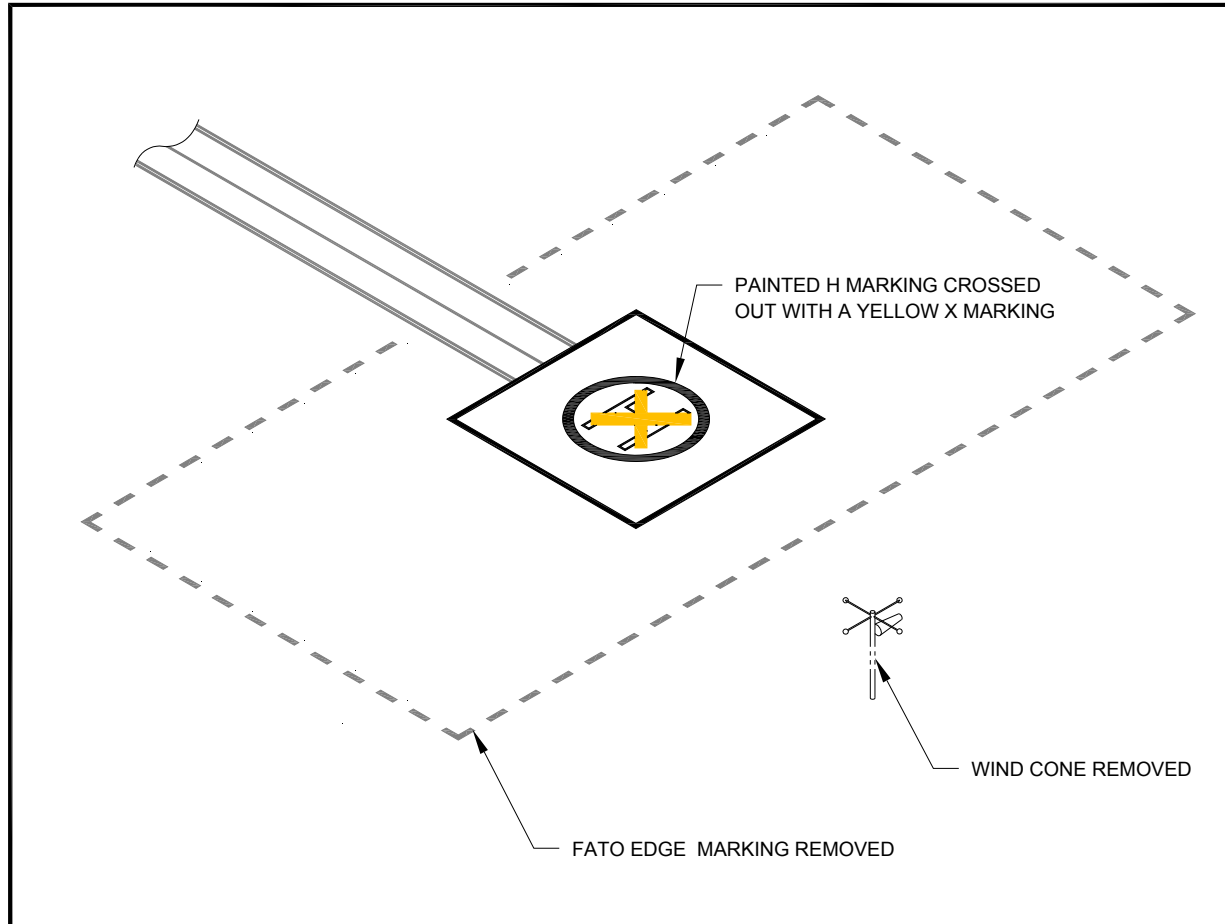
**(5) Parking position weight limit.** If a paved parking position has a weight limitation, mark it in units of 1,000 lbs as illustrated in Figure 3–16. (A "12" indicates a weight-carrying capability of up to 9,000 lbs. Do not use metric equivalents for this purpose.) This marking consists of yellow characters 36 inches (91 cm) high. When necessary to minimize the possibility of being misread, place a bar under the number. See Figure 3–17 and Figure C–1.

**(6) Shoulder line markings.** Use optional shoulder line markings for paved parking areas (Figure 3–12) to ensure safe rotor clearance. Locate a 6-inch (15 cm) wide solid yellow shoulder line, perpendicular to the centerline and extending to the RD marking, so it is under the pilot's shoulder. This ensures the main rotor of the largest helicopter the position will accommodate will be entirely within the rotor diameter parking circle. See Figure 3–16. The FAA recommends a shoulder line marking for "taxi through" parking areas.

**(7) Walkways.** Figure 3–12 illustrates one marking scheme.

**g. Closed heliport.** Obliterate all markings of a permanently closed heliport, FATO, or TLOF. If it is impractical to obliterate markings, place a yellow "X" over the "H", as illustrated in Figure 3–19. Make the yellow "X" large enough to ensure early pilot recognition that the heliport is closed. Remove the wind cone(s) and other visual indications of an active heliport.

**h. Marking sizes.** See Appendix C for guidance on the proportions of painted numbers.



**Figure 3–19. Marking a Closed Heliport: Transport**

**315. Heliport lighting.** For night operations, light the heliport with FATO and/or TLOF perimeter lights as described below. Design flush light fixtures and installation methods to support point loads of the design helicopter transmitted through a skid or wheel.

**a. TLOF – perimeter lights.** Use flush green lights meeting the requirements of FAA Airports Engineering Brief 87, Heliport Perimeter Light for Visual Meteorological Conditions (VMC), to define the TLOF perimeter. Use a minimum of four light fixtures per side of the TLOF. Locate a light at each corner, with additional lights uniformly spaced between the corner lights. Using an odd number of lights on each side will place lights along the centerline of the approach. Install lights at a maximum spacing of 25 feet (7.6 m). Locate flush lights within 1 foot (30 cm) (inside or outside) of the TLOF perimeter. Figure 3–20 and Figure 3–21 illustrate this lighting.

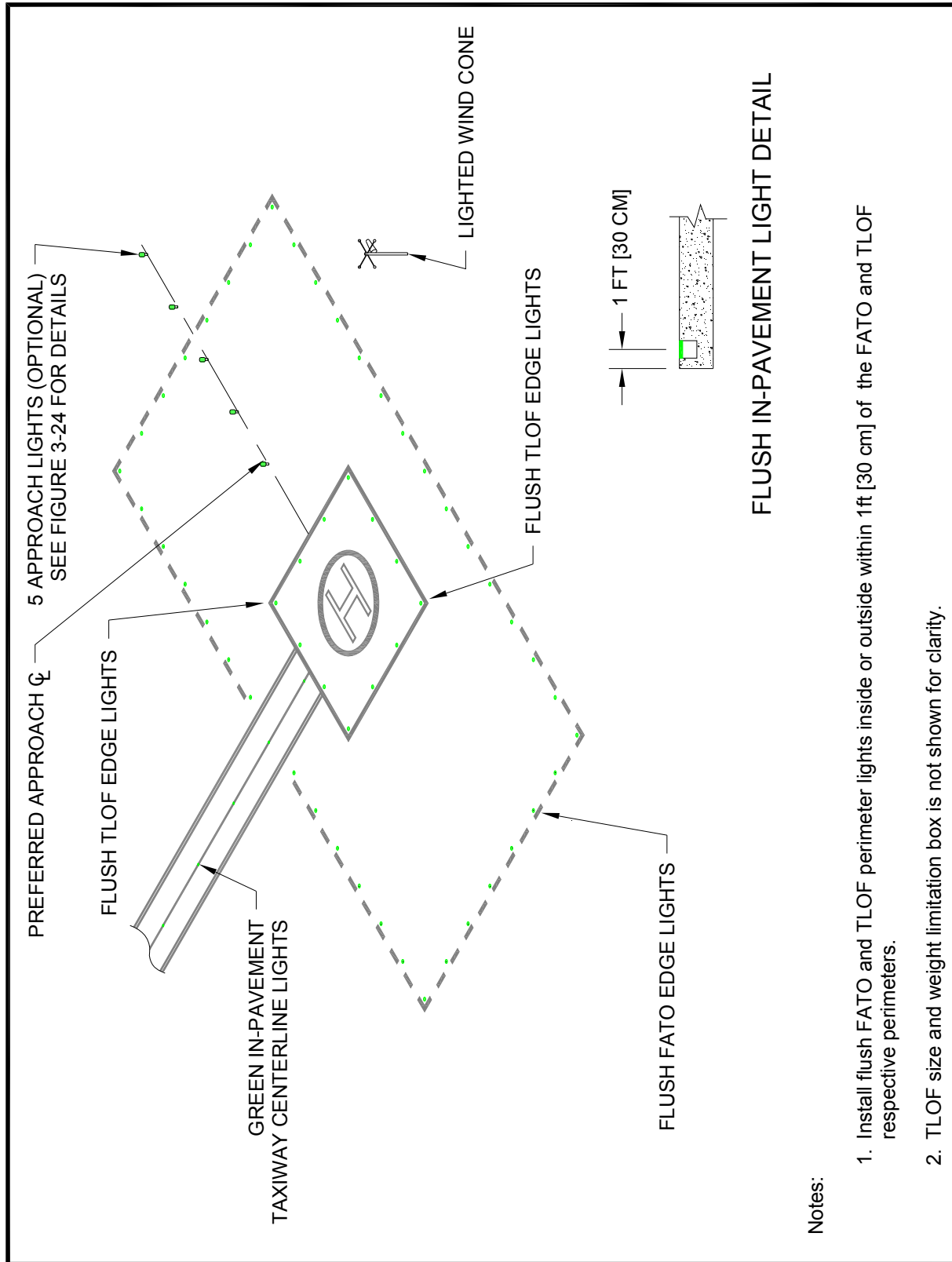


Figure 3–20. TLOF and FATO Flush Perimeter Lighting: Transport

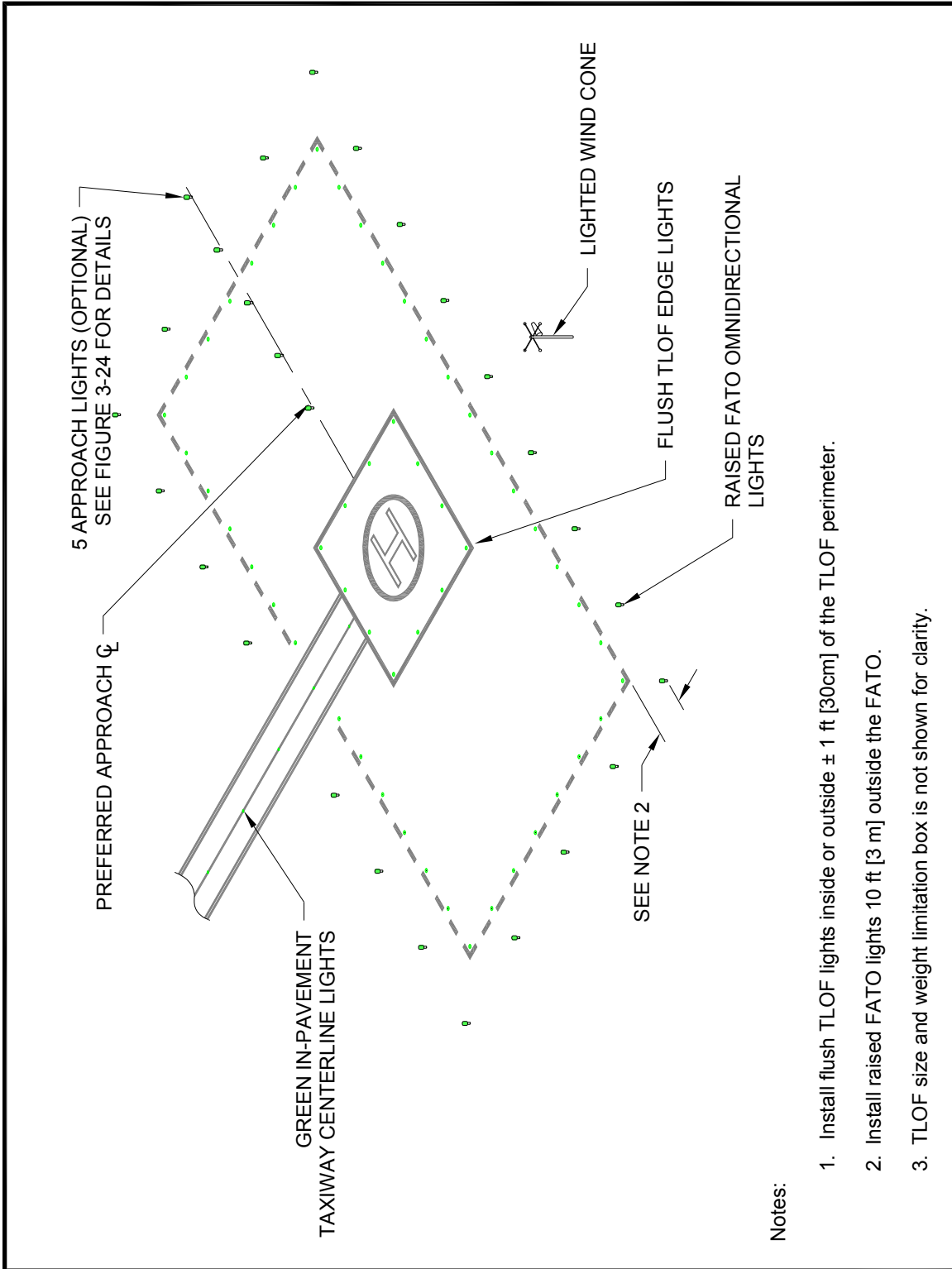


Figure 3–21. FATO Raised and TLOF Flush Perimeter Lighting: Transport

**b. Optional TLOF lights.** As an option, install a line of 7 green, flush lights meeting the standards of EB 87 spaced at 5-foot (1.5 m) intervals in the TLOF pavement. Align these lights on the centerline of the approach course to provide close-in directional guidance and improve TLOF surface definition. These lights are illustrated in Figure 3–22.

**c. Ground level FATO perimeter lights.** Use green lights meeting the requirements of EB 87 to define the limits of the FATO. Locate a light at each corner with additional lights uniformly spaced between the corner lights with a maximum interval of 25 feet (8 m) between lights. Using an odd number of lights on each side will place lights along the centerline of the approach. Locate flush lights within 1 foot (30 cm) inside or outside of the FATO perimeter. Mount raised light fixtures frangibly, no more than 8 inches (20 cm) high, and locate them 10 feet (3 m) out from the FATO perimeter. Make sure they do not penetrate a horizontal plane at the FATO elevation by more than 2 inches (5 cm). See Figure 3–21 and Figure 7–3.

**d. Elevated FATO – perimeter lights.** Lighting for an elevated FATO is the same as for a ground level FATO. As an option, locate lights at the outside edge of the safety net, as shown in Figure 3–23. Make sure the raised lights do not penetrate a horizontal plane at the FATO elevation by more than 2 inches (5 cm). See Figure 7–3.

**e. Floodlights.** Use floodlights to illuminate the parking apron. If possible, mount these floodlights on adjacent buildings to eliminate the need for tall poles. Take care, however, to place floodlights clear of the TLOF, the FATO, the safety area, and the approach/departure surfaces and transitional surfaces and ensure the floodlights and their associated hardware do not constitute an obstruction hazard. Aim floodlights down to provide illumination on the apron surface. Make sure floodlights that might interfere with pilot vision during takeoff and landings are capable of being turned off by pilot control or at pilot request.

**f. Landing direction lights.** As an option when it is necessary to provide directional guidance, install landing direction lights. Landing direction lights are a configuration of five green omnidirectional lights meeting the standards of EB 87 on the centerline of the preferred approach/departure path. Space these lights at 15-foot (4.6 m) intervals beginning at a point not less than 30 feet (9 m) and not more than 60 feet (18 m) from the TLOF perimeter and extending outward in the direction of the preferred approach/departure path, as illustrated in Figure 3–24.

**g. Flight path alignment lights.** As an option, install flight path alignment lights meeting the requirements of EB 87. Place them in a straight line along the direction of approach and/or departure flight paths, extending as necessary across the TLOF, FATO, safety area or any suitable surface in the immediate vicinity of the FATO or safety area. Install three or more green lights spaced at 5 feet (1.5 m) to 10 feet (3.0 m). See Figure 3–9.



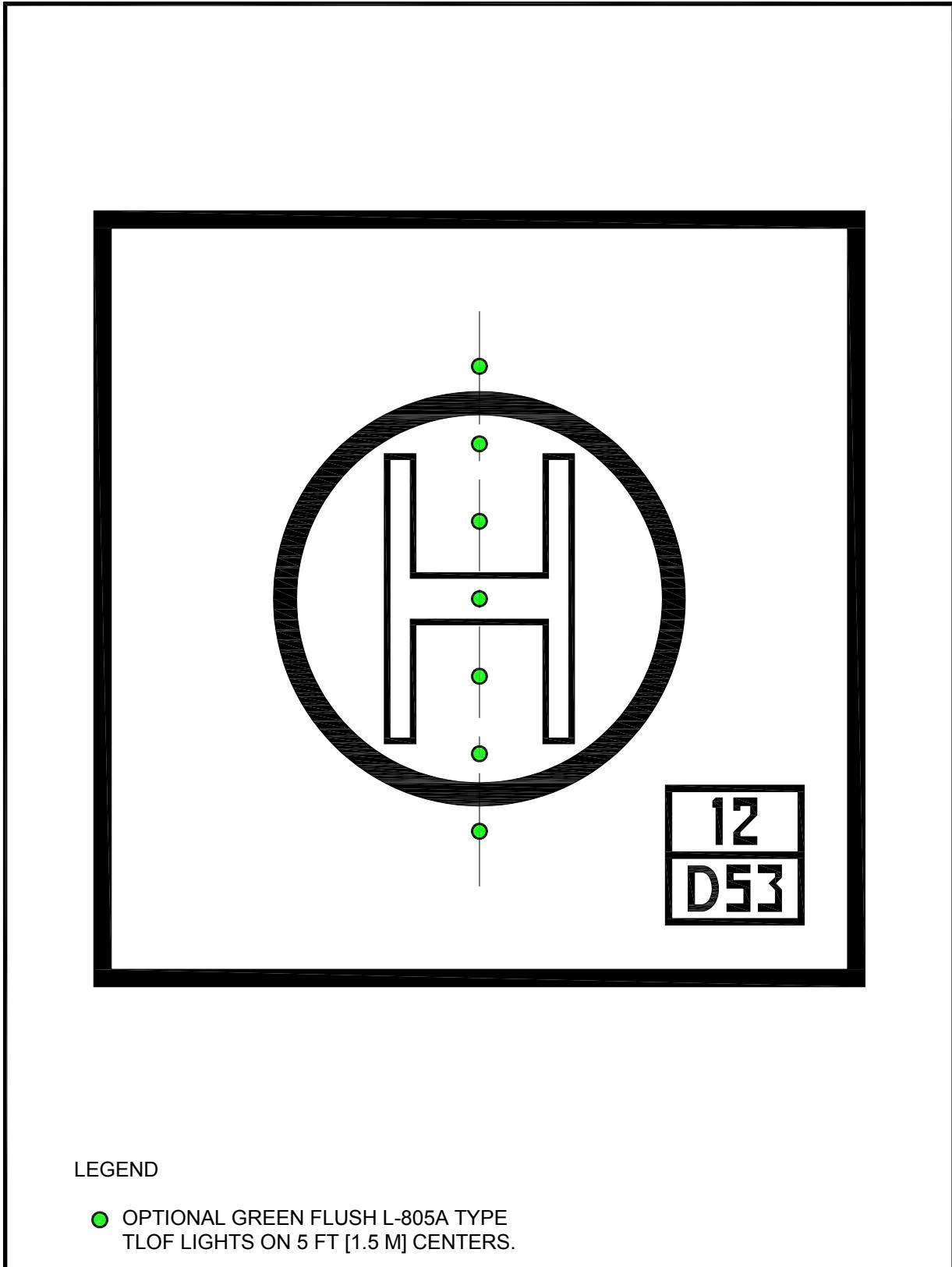
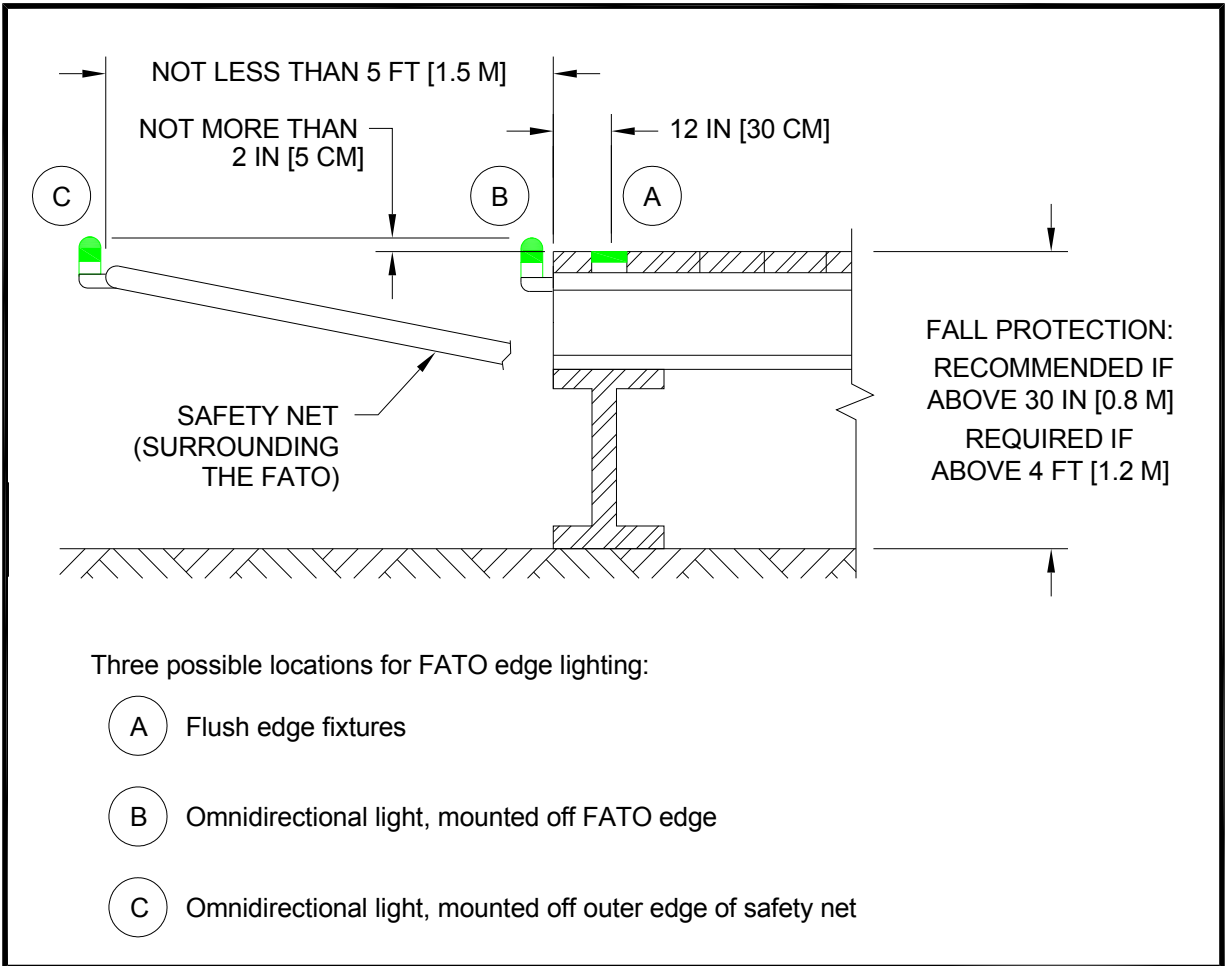


Figure 3–22. Optional TLOF Lights: Transport



**Figure 3–23. Elevated FATO – Perimeter Lighting: Transport**

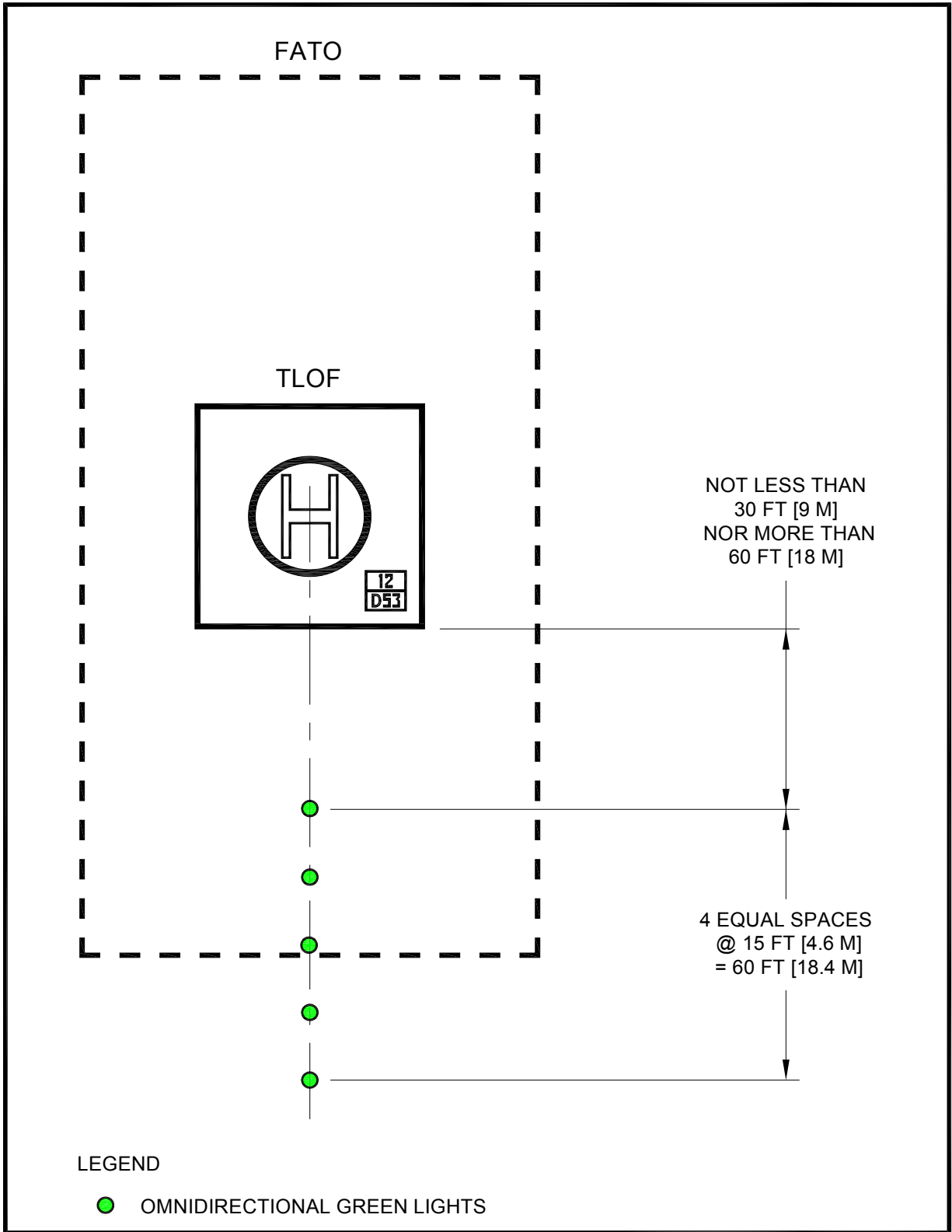


Figure 3-24. Landing Direction Lights: Transport

#### **h. Taxiway and taxi route lighting.**

(1) Taxiway centerline lights. Define taxiway centerlines with flush bidirectional green lights meeting the standards of AC 150/5345-46, Specification for Runway and Taxiway Light Fixtures, for type L-852A (straight segments) or L-852B (curved segments). Space these lights at maximum 50-foot (15 m) longitudinal intervals on straight segments and at maximum 25-foot (7.6 m) intervals on curved segments, with a minimum of four lights needed to define the curve. As an option, uniformly offset taxiway centerline lights no more than two feet (0.6 m) to ease painting the taxiway centerline. Do not use retroreflective markers.

(2) Taxiway edge lights. Use flush omnidirectional blue lights meeting the standards of AC 150/5345-46 for type L-852T to mark the edges of a taxiway. Do not use retroreflective markers.

(a) Straight segments. Space lights at 50-foot (15.2 m) longitudinal intervals on straight segments.

(b) Curved segments. Curved taxiway edges require shorter spacing of edge lights. Base the spacing on the radius of the curve. AC 150/5340-30, Design and Installation Detail for Airport Visual Aids shows the applicable spacing for curves. Space taxiway edge lights uniformly. On curved edges of more than 30 degrees from point of tangency (PT) of the taxiway section to PT of the intersecting surface, install have at least three edge lights. For radii not listed in AC 150/5340-30, determine spacing by linear interpolation.

i. **Heliport identification beacon.** Install a heliport identification beacon. Locate the beacon, flashing white/green/yellow at the rate of 30 to 45 flashes per minute, on or close to the heliport. Find guidance on heliport beacons in AC 150/5345-12, Specification for Airport and Heliport Beacon.

**316. Marking and lighting of difficult-to-see objects.** It is difficult for a pilot to see unmarked wires, antennas, poles, cell towers, and similar objects, even in the best daylight weather, in time to take evasive action. While pilots can avoid such objects during en route operations by flying well above them, approaches and departures require operations near the ground where obstacles may be a factor. This paragraph discusses the marking and lighting of objects near, but outside and below the approach/departure surface. Find guidance on marking and lighting objects in AC 70/7460-1, Obstruction Marking and Lighting.

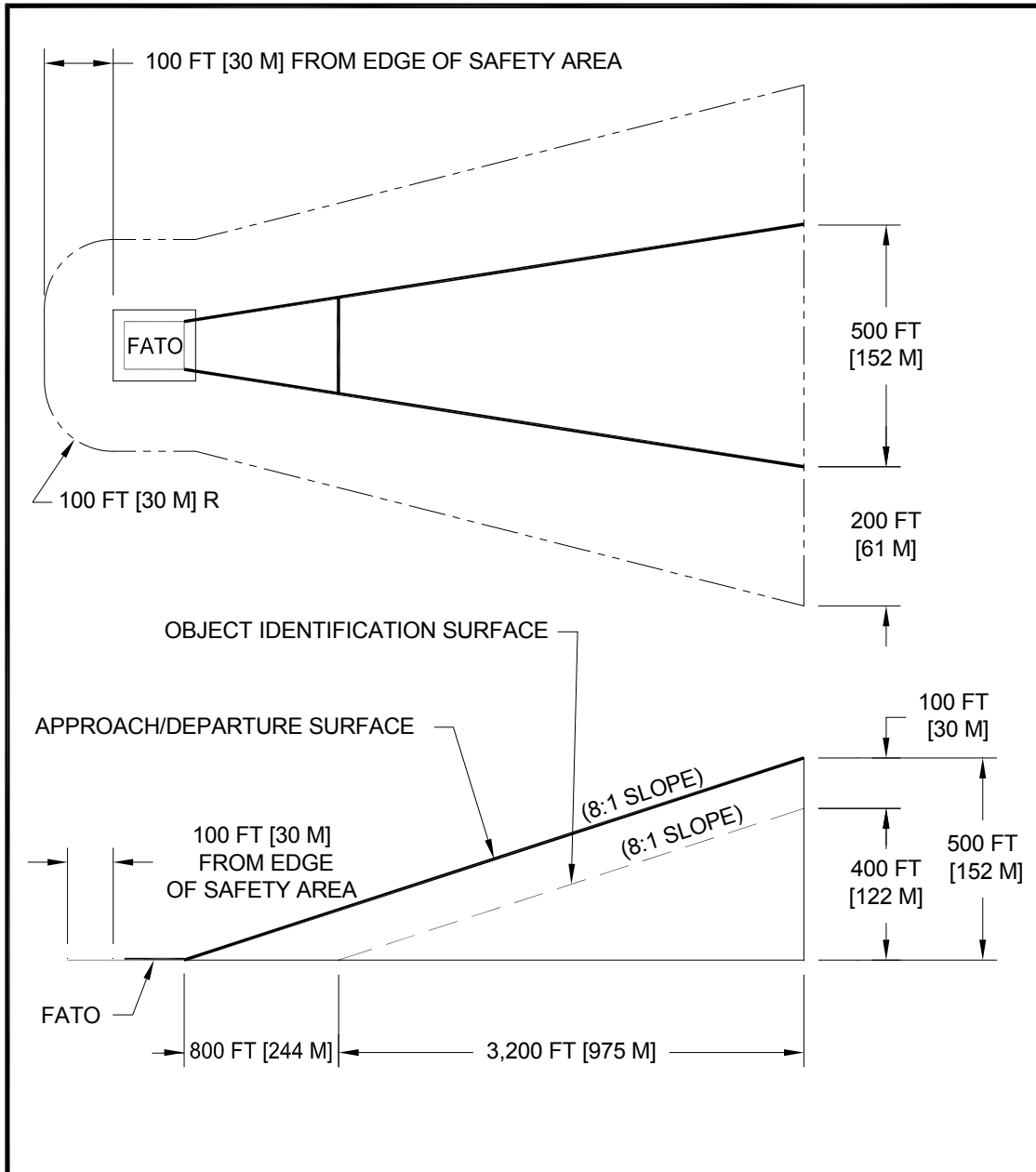
a. **Airspace.** If difficult-to-see objects penetrate the object identification surfaces illustrated in Figure 3-25 and Figure 3-26, mark these objects to make them more conspicuous. If a heliport supports operations between dusk and dawn, light these difficult-to-see objects. The object identification surfaces in Figure 3-25 and Figure 3-26 are described as follows:

(1) In all directions from the safety area except under the approach/departure paths, the object identification surface starts at the safety area perimeter and extends out horizontally for a distance of 100 feet (30.5 m).

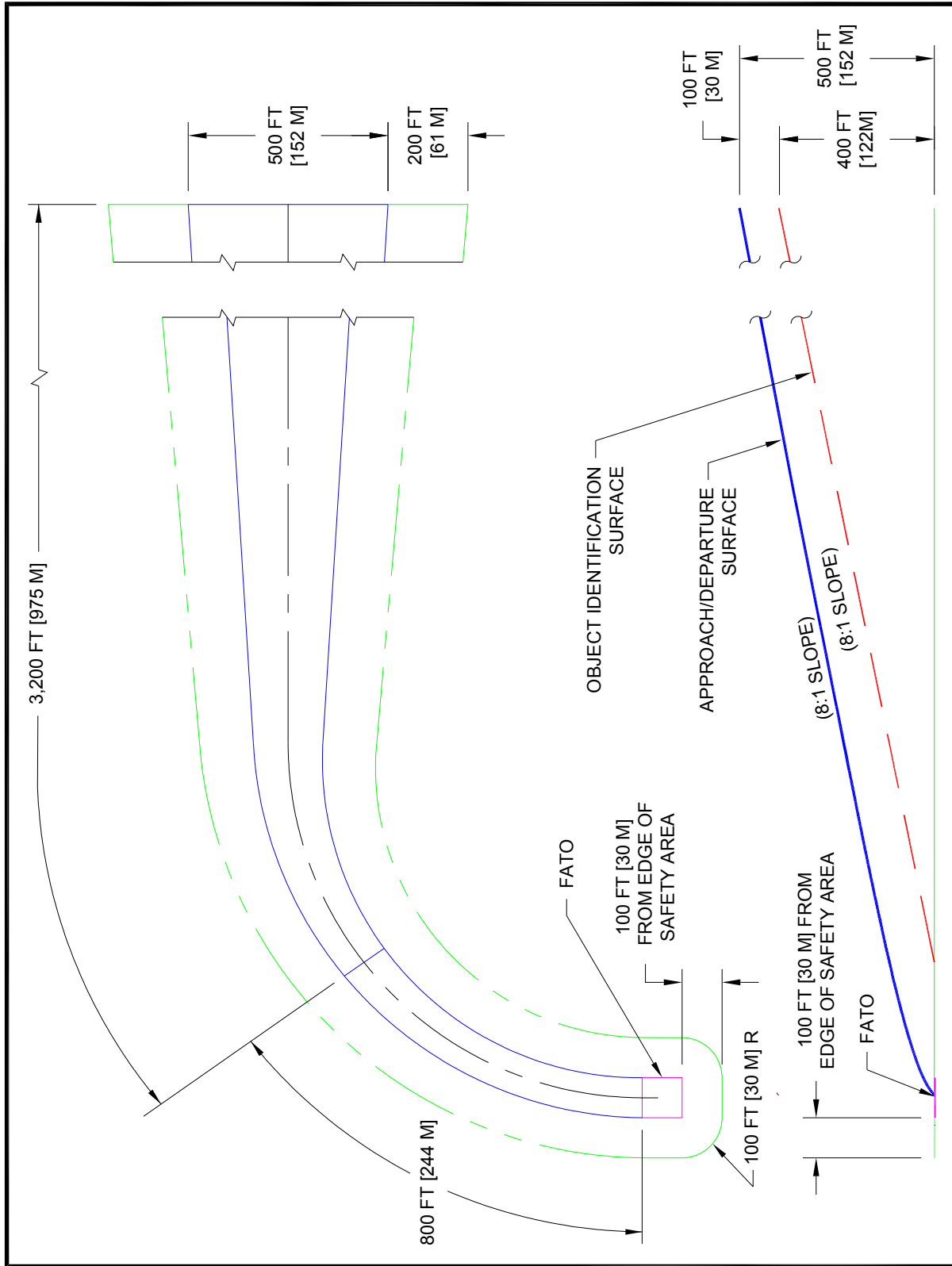
(2) Under the approach/departure surface, the object identification surface starts from the outside edge of the FATO and extends horizontally out along the approach path for a distance of 800 feet (244 m). From this point, the object identification surface extends out for an additional distance of 3,200 feet (975 m) along the approach path while rising on an 8:1 slope (8 units horizontal in 1 unit vertical). From the point 800 feet (244 m) from the FATO perimeter, the object identification surface is 100 feet (30.5 m) beneath the approach/departure surface.

(3) The width of this object identification surface under the approach/departure surface increases as a function of distance from the safety area. From the safety area perimeter, the object identification surface extends laterally to a point 100 feet (30.5 m) outside the safety area perimeter. At the upper end of the surface, the object identification surface extends laterally 200 feet (61 m) on either side of the approach/departure path.

**b. Shielding of objects.** Title 14 CFR Part 77.9, Construction or alteration requiring notice, provides that if there are a number of objects close together, it may not be necessary to mark all of them if they are shielded. To meet the shielding guidelines part 77 requires that an object “be shielded by existing structures of a permanent and substantial nature or by natural terrain or topographic features of equal or greater height, and will be located in the congested area of a city, town, or settlement where the shielded structure will not adversely affect safety in air navigation.”



**Figure 3–25. Airspace Where Marking and Lighting are Recommended:  
Straight Approach: Transport**



**Figure 3–26. Airspace Where Marking and Lighting are Recommended:  
Curved Approach: Transport**

**c. Equipment/object marking.** Make heliport maintenance and servicing equipment, as well as other objects used in the airside operational areas, conspicuous with paint, reflective paint, reflective tape, or other reflective markings. Reference AC 150/5210-5, Painting, Marking, and Lighting of Vehicles Used on an Airport.

**317. Safety considerations.** Consider the safety enhancements discussed below in the design of a heliport. Address other areas, such as the effects of rotor downwash, based on site conditions and the design helicopter.

**a. Security.** Provide a means to keep the operational areas of a heliport clear of people, animals, and vehicles. Use a method to control access depending upon the helicopter location and types of potential intruders.

**(1) Safety barrier.** At ground-level transport heliports, erect a safety barrier around the helicopter operational areas in the form of a fence or a wall. Construct the barrier no closer to the operation areas than the outer perimeter of the safety area. Make sure the barrier does not penetrate any approach/departure (primary or transitional) surface. If necessary in the vicinity of the approach/departure paths, install the barrier well outside the outer perimeter of the safety area.

**(2)** Make sure any barrier is high enough to present a positive barrier to persons inadvertently entering an operational area and yet low enough to be non-hazardous to helicopter operations.

**(3)** Control access to airside areas with locked gates and doors. Display a cautionary sign similar to that illustrated in Figure 3–27 on gates and doors.

**b. Rescue and fire-fighting services.** Heliports are subject to state and local rescue and fire-fighting regulations. Provide a fire hose cabinet or extinguisher at each access gate and each fueling location. At elevated TLOF/FATOs, locate fire hose cabinets, fire extinguishers, and other fire-fighting equipment adjacent to, but below the level, of the TLOF/FATO. Find additional information in various NFPA publications. For more reference material, see Appendix D.

**c. Communications.** Use a Common Traffic Advisory Frequency (CTAF) radio to provide arriving helicopters with heliport and traffic advisory information but do not use this radio to control air traffic. Contact the Federal Communications Commission (FCC) for information on CTAF licensing.

**d. Weather information.** An automated weather observing system (AWOS) measures and automatically broadcasts current weather conditions at the heliport site. When installing an AWOS, locate it at least 100 feet (30 m) and not more than 700 feet (213 m) from the TLOF and such that its instruments will not be affected by rotor wash from helicopter operations. Find guidance on AWOS systems in AC 150/5220-16, Automated Weather Observing Systems (AWOS) for Non-Federal Applications, and FAA Order 6560.20, Siting Criteria for Automated Weather Observing Systems (AWOS). Other weather observing systems will have different siting criteria.

**e. Winter operations.** Swirling snow raised by a helicopter's rotor wash can cause the pilot to lose sight of the intended landing point and/or hide objects that need to be avoided. Design the heliport to accommodate the methods and equipment to be used for snow removal. Design the heliport to allow the snow to be removed sufficiently so it will not present an obstruction hazard to either the tail rotor or the main rotor. Find guidance on winter operations in AC 150/5200-30, Airport Winter Safety and Operations.



Figure 3-27. Caution Sign: Transport



**318. Visual glideslope indicators (VGSI).** A visual glideslope indicator (VGSI) provides pilots with visual vertical course and descent cues. Install the VGSI such that the lowest on-course visual signal provides a minimum of 1 degree of clearance over any object that lies within 10 degrees of the approach course centerline.

**a. Siting.** The optimum location of a VGSI is on the extended centerline of the approach path at a distance that brings the helicopter to a hover with the undercarriage between 3 and 8 feet (0.9 to 2.4 m) above the TLOF. Figure 3–28 illustrates VGSI clearance criteria. To properly locate the VGSI, estimate the vertical distance from the undercarriage to the pilot’s eye.

**b. Control of the VGSI.** As an option, allow the VGSI to be pilot controllable such that it is “on” only when needed.

**c. VGSI needed.** A VGSI is an optional feature. However, provide a VGSI if one or more of the following conditions exist, especially at night:

(1) Obstacle clearance, noise abatement, or traffic control procedures require a particular slope to be flown.

(2) The environment of the heliport provides few visual surface cues.

**d. Additional guidance.** AC 150/5345-52, Generic Visual Glideslope Indicators (GVGI), and AC 150/5345-28, Precision Approach Path Indicator (PAPI) Systems, provide additional guidance.

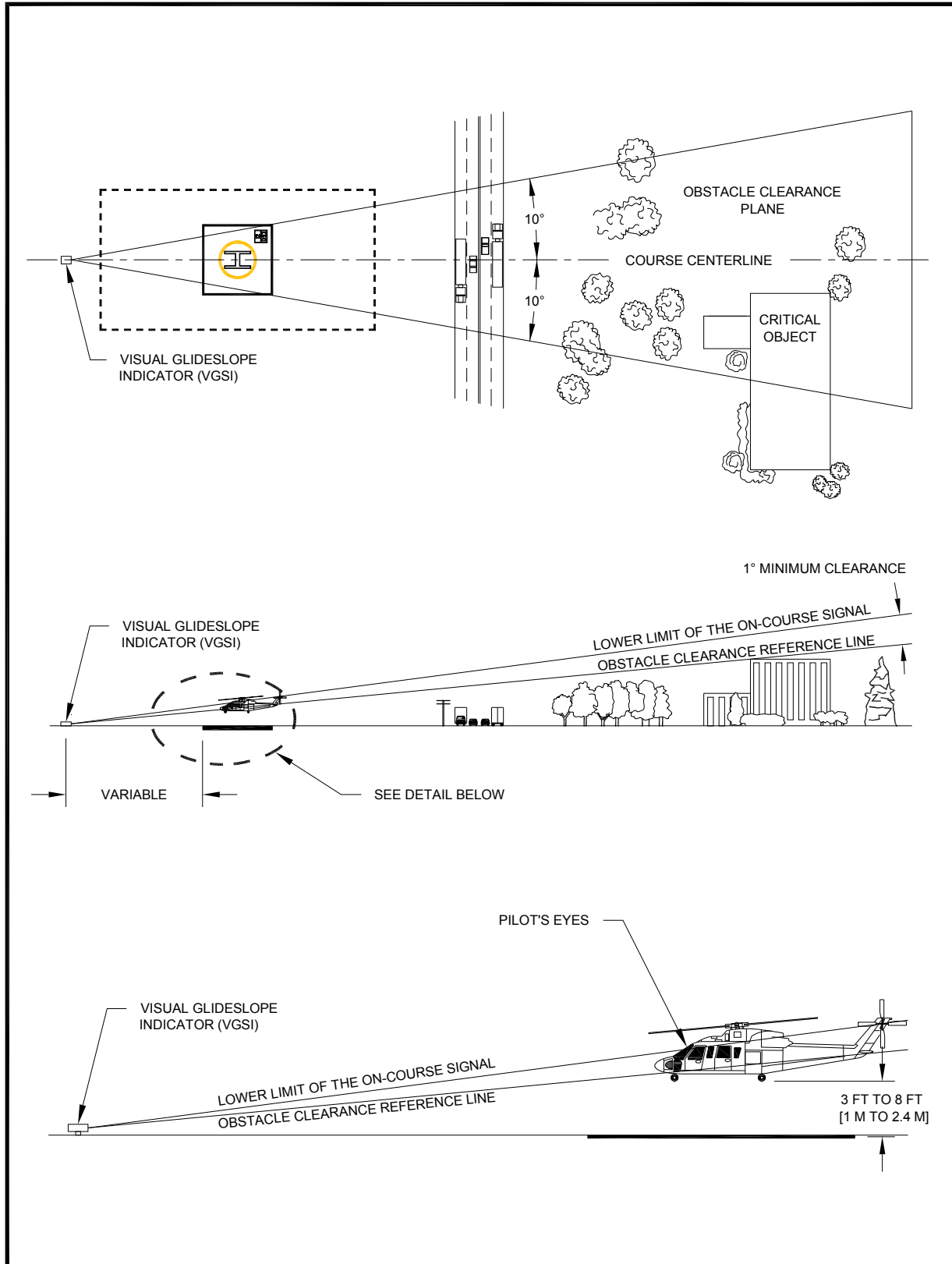


Figure 3–28. Visual Glideslope Indicator Siting and Clearance Criteria: Transport

**319. Terminal facilities.**

**a. Design considerations.** A heliport terminal provides curbside access for passengers using private autos, taxicabs, and public transit vehicles. Public waiting areas need the usual amenities, and a counter for rental car services may be desirable. Design passenger auto parking areas to accommodate current requirements, with the ability to expand them to meet future requirements. Readily available public transportation may reduce the requirement for employee and service personnel auto parking spaces. Build attractive and functional heliport terminal buildings or sheltered waiting areas. Find guidance on designing terminal facilities in AC 150/5360-9, Planning and Design of Airport Terminal Building Facilities at Non-Hub Locations.

**b. Security.** Unless screening was carried out at the helicopter passengers' departure location, Transportation Security Administration regulations may require that a screening area and/or screening be provided before passengers enter the airport's secured areas. If needed, provide multiple helicopter parking positions and/or locations in the terminal area to service helicopter passenger and/or cargo interconnecting needs. Find information about passenger screening at the Transportation Security Administration web site (<http://www.tsa.gov/public/>).

**320. Zoning and compatible land use.** Where state and local statutes permit, the FAA encourages transport heliport operators to promote the adoption of the following zoning measures to ensure the heliport will continue to be available for public use and to protect the community's investment in the facility.

**a. Zoning to limit building/object heights.** Find general guidance on drafting an ordinance that would limit building and object heights in AC 150/5190-4, A Model Zoning Ordinance to Limit Height of Objects Around Airports. Substitute the heliport surfaces for the airport surfaces described in the model ordinance.

**b. Zoning for compatible land use.** The FAA encourages public agencies to enact zoning ordinances to control the use of property within the HPZ and the approach/departure path environment, restricting activities to those that are compatible with helicopter operations. See paragraph 310.

**c. Air rights and property easements.** Use air rights and property easements as options to prevent the encroachment of obstacles in the vicinity of a heliport.

**This page intentionally left blank.**

## Chapter 4. Hospital Heliports

**401. General.** Helicopters are often used to transport injured persons from the scene of an accident to a hospital and to transfer patients from one hospital to another. A hospital heliport accommodates helicopters used by Emergency Medical Services. In some emergencies, a hospital heliport may accommodate large military helicopters.

**402. Applicability.** The standards in this chapter apply to projects funded under the Airport Improvement Program (AIP) or Passenger Facility Charge (PFC) program. For other projects/heliports, these standards are the FAA's recommendations for designing all hospital heliports. This chapter highlights issues that are unique to hospital heliports and issues for which the design standards are different than those recommended for other general aviation heliports, but also includes standards that are common to other general aviation heliports. These standards address the design of a heliport that will accommodate air ambulance helicopter operations and emergency medical service (EMS) personnel and equipment. These standards are based on the understanding that pilots landing at the heliport are familiar with the facility. However, the heliport operator assumes the responsibility of ensuring the necessary information is readily available to pilots. Alternately, the heliport operator may choose to build the heliport to full general aviation standards. The design standards in this chapter assume there will never be more than one helicopter within the final approach and takeoff area (FATO) and the associated safety area. If there is a need for more than one touchdown and lift-off area (TLOF) at a heliport, locate each TLOF within its own FATO. Consider the feasibility of accommodating large military helicopters that might be used in an emergency.

**403. Access by individuals with disabilities.** Various laws require heliports operated by public entities and those receiving federal financial assistance to meet accessibility requirements. See paragraph 114.

### **404. Heliport site selection.**

**a. Planning.** Public agencies and others planning to develop a hospital heliport are encouraged to select a site capable of supporting instrument operations, future expansion, and military helicopters that will be used in disaster relief efforts.

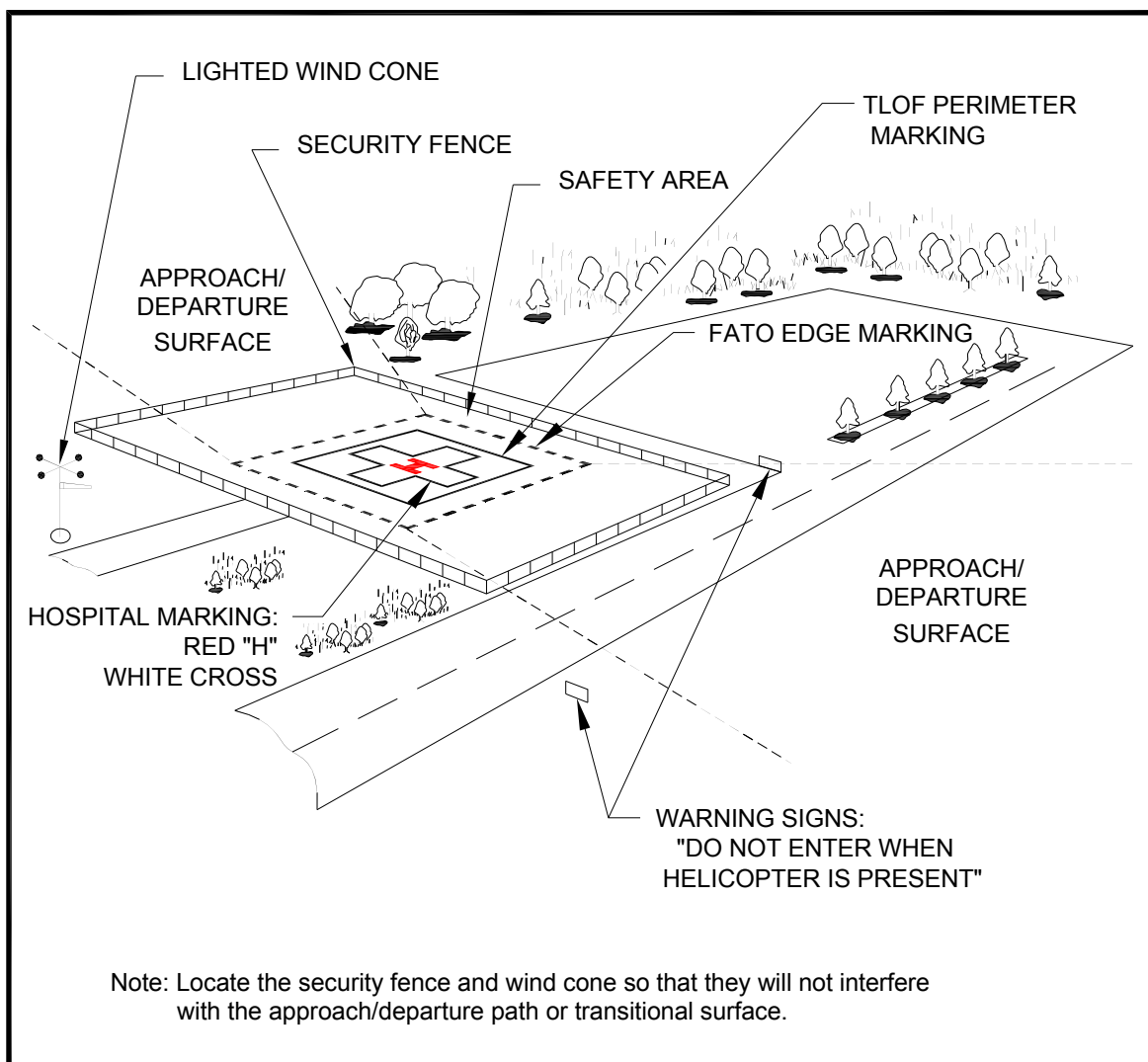
**b. Property requirements.** A functional hospital heliport may be as simple as a cleared area on the ground, together with a wind cone and a clear approach/departure path. Figure 4-1 illustrates the essential elements of a ground-level hospital heliport.

**c. Turbulence.** Air flowing around and over buildings, stands of trees, terrain irregularities, etc. can create turbulence on ground-level and roof-top heliports that may affect helicopter operations. Where the FATO is located near the edge and top of a building or structure, or within the influence of turbulent wakes from other buildings or structures, assess the turbulence and airflow characteristics in the vicinity of, and across the surface of the FATO to determine if an air-gap between the roof, roof parapet or supporting structure, and/or some other turbulence mitigating design measure is necessary. FAA Technical Report FAA/RD-84/25, Evaluating Wind Flow Around Buildings on Heliport Placement, addresses the wind's effect on helicopter operations. Take the following actions in selecting a site to minimize the effects of turbulence.

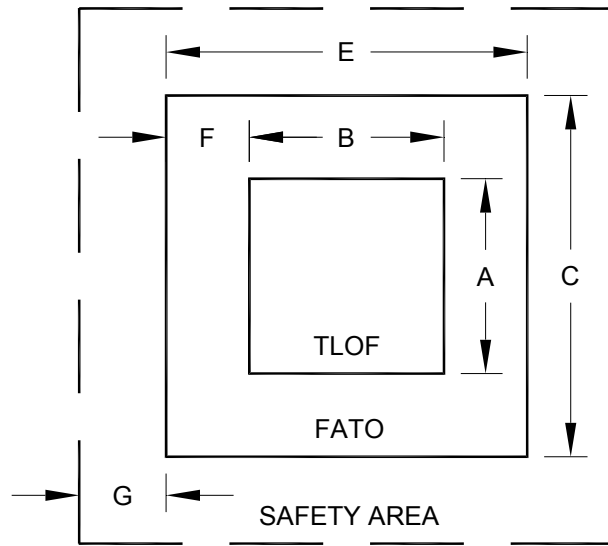
**(1) Ground-level heliports.** Features such buildings, trees, and other large objects can cause air turbulence and affect helicopter operations from sites immediately adjacent to them. Therefore, locate the landing and takeoff area away from such objects in order to minimize air turbulence in the vicinity of the FATO and the approach/departure paths.

**(2) Elevated heliports.** Establishing a 6 foot (1.8 m) or more air gap on all sides above the level of the roof will generally minimize the turbulent effect of air flowing over the roof edge. If an air gap is included in the design, keep it free at all times of objects that would obstruct the airflow. If it is not practical to include an air gap or some other turbulence mitigating design measure where there is turbulence, operational limitations may need to be considered under certain wind conditions. See paragraph 101.

**d. Electromagnetic effects.** Nearby electromagnetic devices, such as a magnetic resonance imaging machine (MRI), large ventilator motor, elevator motor, or other large electrical consumer may cause temporary aberrations in the helicopter magnetic compass and interfere with other onboard navigational equipment. Be alert to the location of any MRI with respect to the heliport location. A warning sign alerting pilots to the presence of an MRI is recommended. Take steps to inform pilots of the locations of MRIs and other similar equipment. For additional information, see FAA Technical Report FAA/RD-92/15, Potential Hazards of Magnetic Resonance Imagers to Emergency Medical Service Helicopter Services.



**Figure 4–1. Essential Features of a Ground-level Hospital Heliport: Hospital**



DIM	ITEM	VALUE	NOTES
A	Minimum TLOF Length	1 RD but not less than 40 ft [12 m]	
B	Minimum TLOF Width	1 RD but not less than 40 ft [12 m]	
C	Minimum FATO Length	1 ½ D	See Paragraph 406.b.(1) for adjustments of elevations above 1,000 ft
E	Minimum FATO Width	1 ½ D	
F	Minimum Separation Between the Perimeters of the TLOF and FATO	¾ D - ½ RD	
G	Minimum Safety Area Width	see Table 4-1	

Note: For a circular TLOF and FATO, dimensions A, B, C and E refer to diameters.

**Figure 4–2. TLOF/FATO Safety Area Relationships and Minimum Dimension: Hospital**

**405. Basic layout.** The heliport consists of a TLOF contained within a FATO. A safety area surrounds the FATO. The relationship of the TLOF to the FATO and the safety area is shown in Figure 4–2. A FATO contains only one TLOF. Provide appropriate approach/departure airspace to allow safe approaches to and departures from landing sites. To the extent feasible, align the preferred approach/departure path with the predominant winds. See paragraph 409.

**406. Touchdown and liftoff area (TLOF).**

**a. TLOF location.** TLOFs of hospital heliports are at ground level, on an elevated structure, or at rooftop level. Center the TLOF within the FATO.

**b. TLOF size.** The minimum TLOF dimension (length, width, or diameter) is equal to the rotor diameter (RD) of the design helicopter but not less than 40 feet (12 m). Design the TLOF to be rectangular or circular. Each design shape has its advantages. A square or rectangular shape provides the pilot with better alignment cues than a circular shape, but a circular TLOF may be more recognizable in an urban environment. Increasing the load-bearing area (LBA) centered on the TLOF may provide some safety and operational advantages. Increasing the TLOF dimensions may enhance safety factors and/or operational efficiency.

**(1) Elevated hospital heliport.** If the FATO outside the TLOF is non-load-bearing, increase the minimum width, length or diameter of the TLOF to the overall length (D) of the design helicopter.

**(2) Elongated TLOF.** An elongated TLOF can provide an increased safety margin and greater operational flexibility. As an option, design an elongated TLOF with a landing position in the center and two takeoff positions, one at either end, as illustrated in Figure 4–3. Design the landing position to have a minimum length of the RD of the design helicopter. If the TLOF is elongated, also provided an elongated FATO.

**c. Ground-level TLOF surface characteristics.**

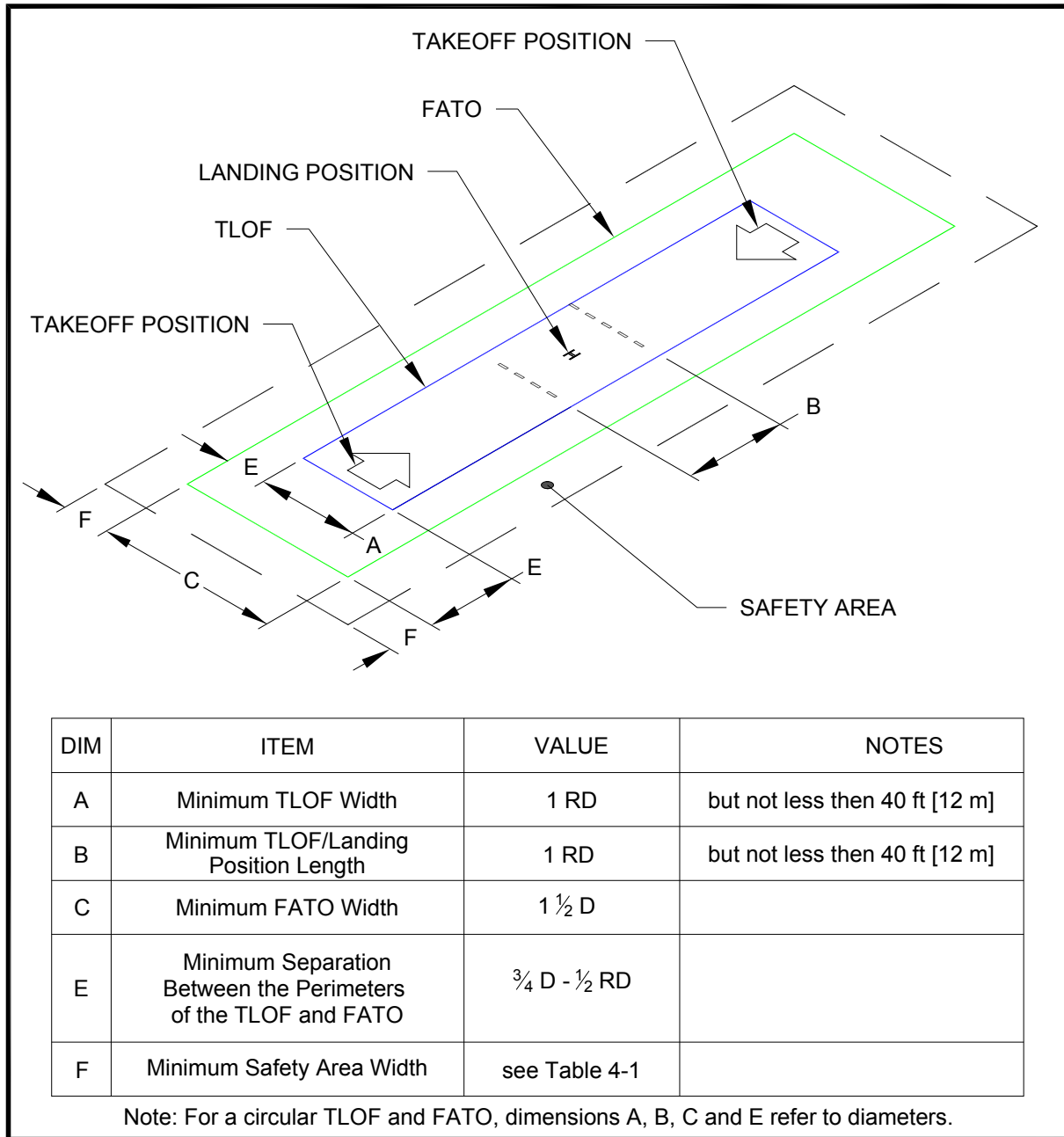
**(1) Design loads.** Design the TLOF and any supporting TLOF structure to be capable of supporting the dynamic loads of the design helicopter.

**(2) Paving.** The standard for the TLOF surface is either paved or aggregate-turf (see AC 150/5370-10, Standards for Specifying Construction of Airports items P-217 and P-501). Use portland cement concrete (PCC) when feasible for ground-level facilities. An asphalt surface is less desirable for heliports as it may rut under the wheels or skids of a parked helicopter. This has been a factor in some rollover accidents. Use a broomed or roughened pavement finish to provide a skid-resistant surface for helicopters and non-slippery footing for people.

**d. Rooftop and other elevated TLOFs.**

**(1) Design loads.** Design elevated TLOFs and any TLOF supporting structure to be capable of supporting the dynamic loads of the design helicopter.





**Figure 4-3. Elongated FATO with Two Takeoff Positions: Hospital**

**(2) Elevation.** Elevate the TLOF above the level of any obstacle in the FATO and safety area that cannot be removed. Exception: Edge restraints of minimal height (no higher than 4 inches) on ramps may project above the elevation of the edge of the TLOF.

**(3) Obstructions.** Elevator penthouses, cooling towers, exhaust vents, fresh-air vents, and other raised features can affect heliport operations. Establish control mechanisms to ensure obstruction hazards are not installed after the heliport is operational.

**(4) Air Quality.** Helicopter exhaust can affect building air quality if the heliport is too close to fresh air vents. When designing a building intended to support a helipad, locate fresh air vents accordingly. When adding a helipad to an existing building, relocate fresh air vents if necessary or, if

relocation is not practical, installing charcoal filters or a fresh air intake bypass louver system for HVAC systems may be adequate.

**(5) TLOF surface characteristics.** Construct rooftop and other elevated heliport TLOFs of metal, concrete, or other materials subject to local building codes. Use a finish for TLOF surfaces that provides a skid-resistant surface for helicopters and non-slippery footing for people.

**(6) Safety net.** If the platform is elevated 4 feet (1.2 m) or more above its surroundings, Title 29 CFR Part 1910.23, Guarding Floor and Wall Openings and Holes, requires the provision of fall protection. The FAA recommends such protection for all platforms elevated 30 inches (76 cm) or more. However, do not use permanent railings or fences since they would be safety hazards during helicopter operations. As an option, install a safety net, meeting state and local regulations but not less than 5 feet (1.5 m) wide. Design the safety net to have a load carrying capability of 25 lbs/sq ft (122 kg/sq m). Make sure the net, as illustrated in Figure 4–29, does not project above the level of the TLOF. Fasten both the inside and outside edges of the safety net to a solid structure. Construct nets of materials that are resistant to environmental effects.

**(7) Access to elevated TLOFs.** Title 29 CFR Part 1926.34, Means of Egress requires two separate access points for an elevated structure such as an elevated TLOF. Provide access to and from the TLOF via a ramp in order to provide for quick and easy transportation of a patient on a gurney. Build ramps in accordance with state and local requirements. Design the width of the ramp, and any turns in the ramp, to be wide enough to accommodate a gurney with a person walking on each side. Design straight segments of the ramp to be at least 6 feet (1.8 m) wide. Additional width may be required in the turns. Provide the ramp with a slip-resistant surface, with a slope no steeper than 12:1 (12 units horizontal in 1 unit vertical). While it is possible to move a gurney to and from the TLOF using a lift, avoid this, since it invariably results in a delay in the movement of patients in time-critical conditions. Design stairs in compliance with Title 29 CFR Part 1910.24, Fixed Industrial Stairs. Design handrails required by this standard to fold down or be removable to below the level of the TLOF so they will not be hazards during helicopter operations.

**e. TLOF gradients.** Recommended TLOF gradients are defined in Chapter 7.

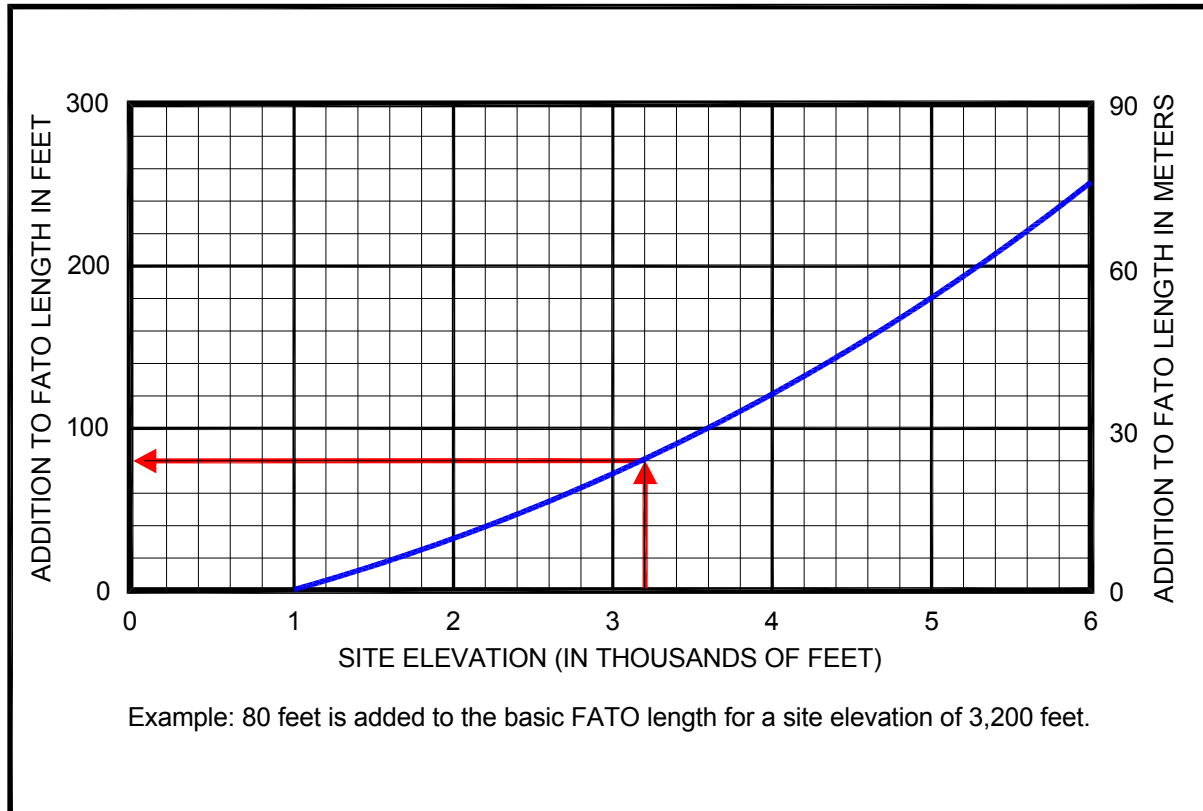
**407. Final approach and takeoff area (FATO).** A hospital heliport has at least one FATO. The FATO contains a TLOF within its borders at which arriving helicopters terminate their approach and from which departing helicopters take off.

**a. FATO location.** FATOs of hospital heliports are at ground level, on an elevated structure, or on a rooftop. To avoid or minimize the need for additional ground transport, locate the FATO to provide ready access to the hospital's emergency room, but such that buildings and other objects are outside the safety area and below obstacle clearance surfaces. The relationship of the FATO to the TLOF and the safety area is shown in Figure 4–2.

**b. FATO size.**

**(1)** Design the FATO so its minimum width, length, or diameter is  $1\frac{1}{2}$  times the overall length (D) of the design helicopter. Design the FATO to be circular or rectangular, regardless of the shape of the TLOF. At elevations above 1,000 feet MSL, include a longer FATO to provide an increased safety margin and greater operational flexibility. Use the additional FATO length as depicted in Figure 4–4.

**(2)** Design the minimum distance between the TLOF perimeter and the FATO perimeter to be not less than  $\frac{3}{4}D - \frac{1}{2}RD$ , where D is the overall length and RD is the rotor diameter of the design helicopter. Note that if the TLOF and FATO are not of similar shape, this applies at all points of the TLOF perimeter. The relationship of the TLOF to the FATO and the safety area is shown in Figure 4–2.



**Figure 4-4. Additional FATO Length for Heliports at Higher Elevation: Hospital**

**c. FATO Surface characteristics.** If the heliport operator marks the TLOF, the FATO outside the TLOF need not be load-bearing.

**(1) Ground-level hospital heliports.** If the heliport operator does not mark the TLOF, and/or intends that the helicopter be able to land anywhere within the FATO, design the FATO outside the TLOF and any FATO supporting structure, like the TLOF, to be capable of supporting the dynamic loads of the design helicopter.

**(2) Elevated hospital heliports.** The FATO outside the TLOF may extend into clear airspace. However, there are some helicopter performance benefits and increased operational flexibility if the FATO outside the TLOF is load bearing. Design the FATO outside of the TLOF to be load-bearing unless the minimum width and length or diameter of TLOF is increased to the overall length of the design helicopter.

**(3)** If the FATO is load bearing, design the portion abutting the TLOF to be contiguous with the TLOF, with the adjoining edges at the same elevation.

**(4)** If the FATO is unpaved, treat the FATO to prevent loose stones and any other flying debris caused by rotor downwash.

**(5)** When the FATO or the LBA in which it is located is elevated 4 feet (1.2 m) or more above its surroundings, part 1910.23 requires the provision of fall protection. The FAA recommends such protection for all platforms elevated 30 inches (76 cm) or more. However, do not use permanent railings or fences, since they would be safety hazards during helicopter operations. As an option, install a safety net, meeting state and local regulations but not less than 5 feet (1.5 m) wide. Design the safety net to have a load carrying capability of 25 lbs/sq ft (122 kg/sq m). Make sure the net, as illustrated in Figure 4-29,

does not project above the level of the TLOF. Fasten both the inside and outside edges of the safety net to a solid structure. Construct nets of materials that are resistant to environmental effects.

**d. Mobile objects within the FATO.** The FATO design standards in this AC assume the FATO is closed to other aircraft if a helicopter or other mobile object is within the FATO or the associated safety area.

**e. Fixed objects within the FATO.** Remove all fixed objects projecting above the FATO elevation except for lighting fixtures, which may project a maximum of 2 inches (5 cm). See Figure 7–3. For ground level heliports, remove all above-ground objects to the extent practicable.

**f. FATO/FATO separation.** If a heliport has more than one FATO, separate the perimeters of the two FATOs so the respective safety areas do not overlap. This separation assumes simultaneous approach/departure operations will not take place. If the heliport operator intends for the facility to support simultaneous operations, provide a minimum 200 foot (61 m) separation.

**g. FATO gradients.** Recommended FATO gradients are defined in Chapter 7.

**408. Safety area.** A safety area surrounds a FATO.

**a. Safety area width.** The standards for the width of the safety area are shown in Table 4-1. The width is the same on all sides. The provision or absence of standard heliport markings affects the width standards. As an option, design the safety area to extend into clear airspace.

**b. Mobile objects within the safety area.** The safety area design standards of this AC assume the TLOF and FATO are closed to other aircraft if a helicopter or other mobile object is within the FATO or the safety area.

**c. Fixed objects within a safety area.** Remove all fixed objects within a safety area projecting above the FATO elevation except for lighting fixtures, which may project a maximum of 2 inches (5 cm). See Figure 7–3. For ground level heliports, remove all above-ground objects to the extent practicable.

**d. Safety area surface.** The safety area need not be load bearing. Figure 4–5 depicts a non-load-bearing safety area. If possible, design the portion of the safety area abutting the FATO to be contiguous with the FATO with the adjoining edges at the same elevation. This is needed in order to avoid the risk of catching a helicopter skid or wheel. Clear the safety area of flammable materials and treat the area to prevent loose stones and any other flying debris caused by rotor wash.

**e. Safety gradients.** Recommended safety area gradients are defined in Chapter 7.

**Table 4-1. Minimum VFR Safety Area Width as a Function of Hospital Heliport Markings**

<b>TLOF Perimeter Marked</b>	Yes	Yes	No	No
<b>FATO Perimeter Marked</b>	Yes	Yes	Yes	Yes
<b>Standard Hospital Marking Symbol</b>	Yes	No	Yes	No
<b>Hospital heliports</b>	$\frac{1}{3}$ RD but not less than 10 ft (3 m)**	$\frac{1}{3}$ RD but not less than 20 ft (6 m)**	$\frac{1}{2}$ D but not less than 20 ft (6 m)	$\frac{1}{2}$ D but not less than 30 ft (9 m)
D: overall length of the design helicopter RD: rotor diameter of the design helicopter ** Also applies when the heliport operator does not mark the FATO. Do not mark the FATO if (a) the FATO (or part of the FATO) is a non-load bearing surface and/or (b) the TLOF is elevated above the level of a surrounding load bearing area.				

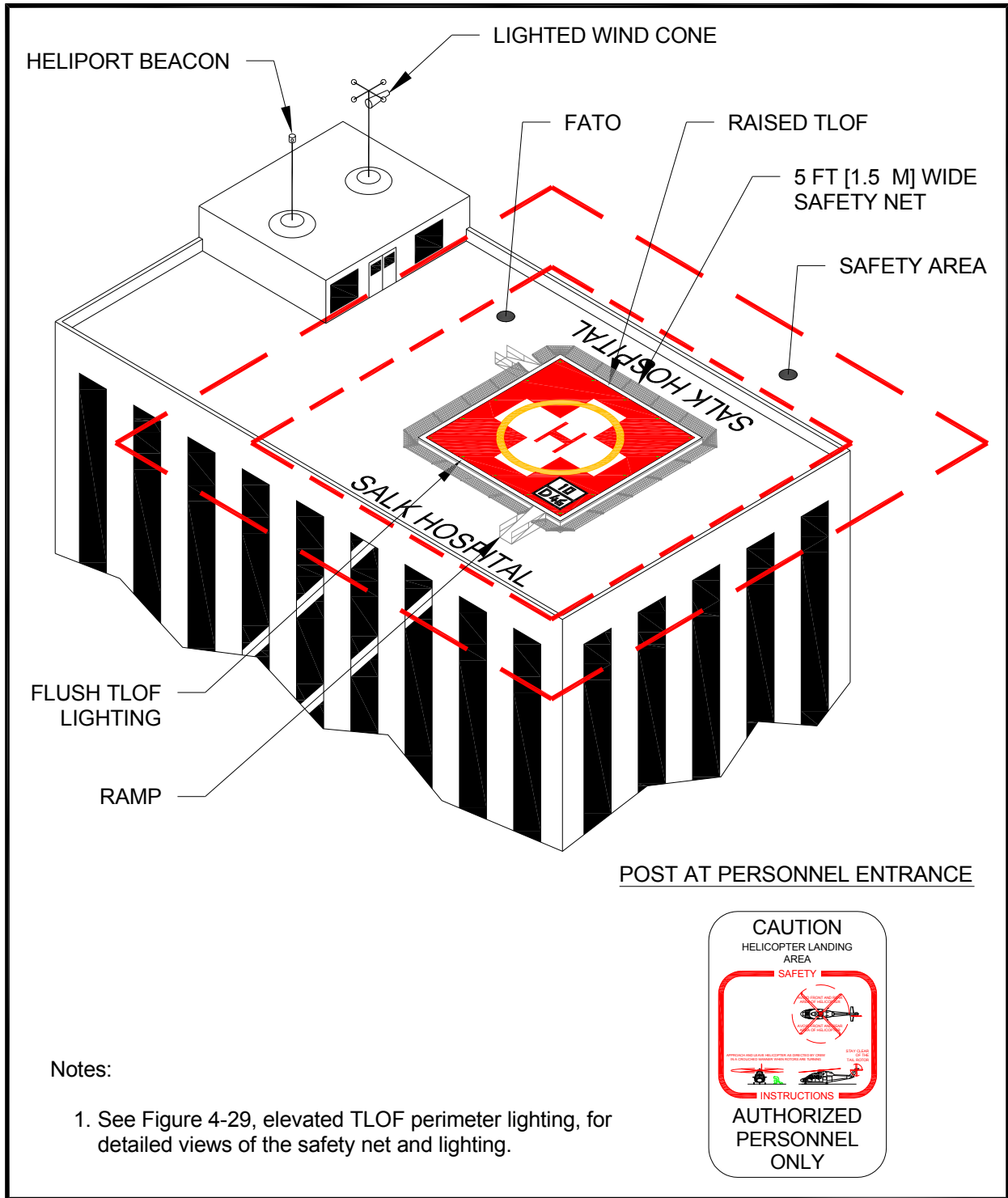


Figure 4-5. Rooftop Hospital Heliport: Hospital

**409. VFR approach/departure paths.** The purpose of approach/departure airspace as shown in Figure 4–6 is to provide sufficient airspace clear of hazards to allow safe approaches to and departures from the TLOF.

**a. Number of approach/departure paths.** Align preferred approach/departure paths with the predominant wind direction so downwind operations are avoided and crosswind operations are kept to a minimum. To accomplish this, design the heliport to have more than one approach/departure path. Base other approach/departure paths on the assessment of the prevailing winds or, when this information is not available, separate such flight paths and the preferred flight path by at least 135 degrees. (See Figure 4–6.) Designing a hospital heliport to have only a single approach/departure path is an undesirable option. A second flight path provides additional safety margin and operational flexibility. If it is not feasible to provide complete coverage of wind through multiple approach/departure paths, operational limitations may be necessary under certain wind conditions. See paragraph 101.

**b. VFR approach/departure and transitional surfaces.** Figure 4–6 illustrates the approach/departure and transitional surfaces.

(1) An approach/departure surface is centered on each approach/departure path. The approach/departure path starts at the edge of the FATO and slopes upward at 8:1 (8 units horizontal in 1 unit vertical) for a distance of 4,000 feet (1,219 m) where the width is 500 feet (152 m) at a height of 500 feet (152 m) above the heliport elevation.

(2) The transitional surfaces start from the edges of the FATO parallel to the flight path center line, and from the outer edges of approach/departure surface, and extend outwards at a slope of 2:1 (2 units horizontal in 1 unit vertical) for a distance of 250 feet (76 m) from the centerline. The transitional surface is not applied on the FATO edge opposite the approach/departure surface. See Figure 4–6.

(3) Make sure the approach/departure and transitional surfaces are free of penetrations unless an FAA aeronautical study determines such penetrations not to be hazards. The FAA conducts such aeronautical studies only at public heliports; heliports operated by a federal agency or the Department of Defense; and private airports with FAA-approved approach procedures. Paragraph 111 provides additional information on hazards to air navigation.

(4) At hospital heliports, an alternative to considering transitional surfaces is to increase the size of the 8:1 approach/departure surface for a distance of 2,000 feet (610 m) as shown in Figure 2–9 and Figure 2–11. The lateral extensions on each side of the 8:1 approach/departure surface start at the width of the FATO and increase so at a distance of 2,000 feet (610 m) from the FATO they are 100 feet (30 m) wide. Make sure obstacles do not penetrate into both Area A and Area B. Make sure obstacles do not penetrate into Area A or Area B unless the FAA determines that the penetration is not a hazard. Mark or light all such penetrations. See paragraph 111 for more information on hazard determinations.

**c. Curved VFR approach/departure paths.** As an option, include one curve in VFR approach/departure paths. As an option, design these paths to use the airspace above public lands, such as freeways or rivers. When including a curved portion in the approach/departure path, make sure the sum of the radius of the arc defining the center line and the length of the straight portion originating at the FATO is not less than 1,886 feet (575 m). Design the approach/departure path so the minimum radius of the curve is 886 feet (270 m) and that the curve follows a 1,000 feet (305 m) straight section. Design the approach/departure path so the combined length of the center line of the curved portion and the straight portion is 4,000 feet (1,219 m). See Figure 4–7. Figure 4–9 shows a curved approach/departure path for an 8:1 approach/departure surface.

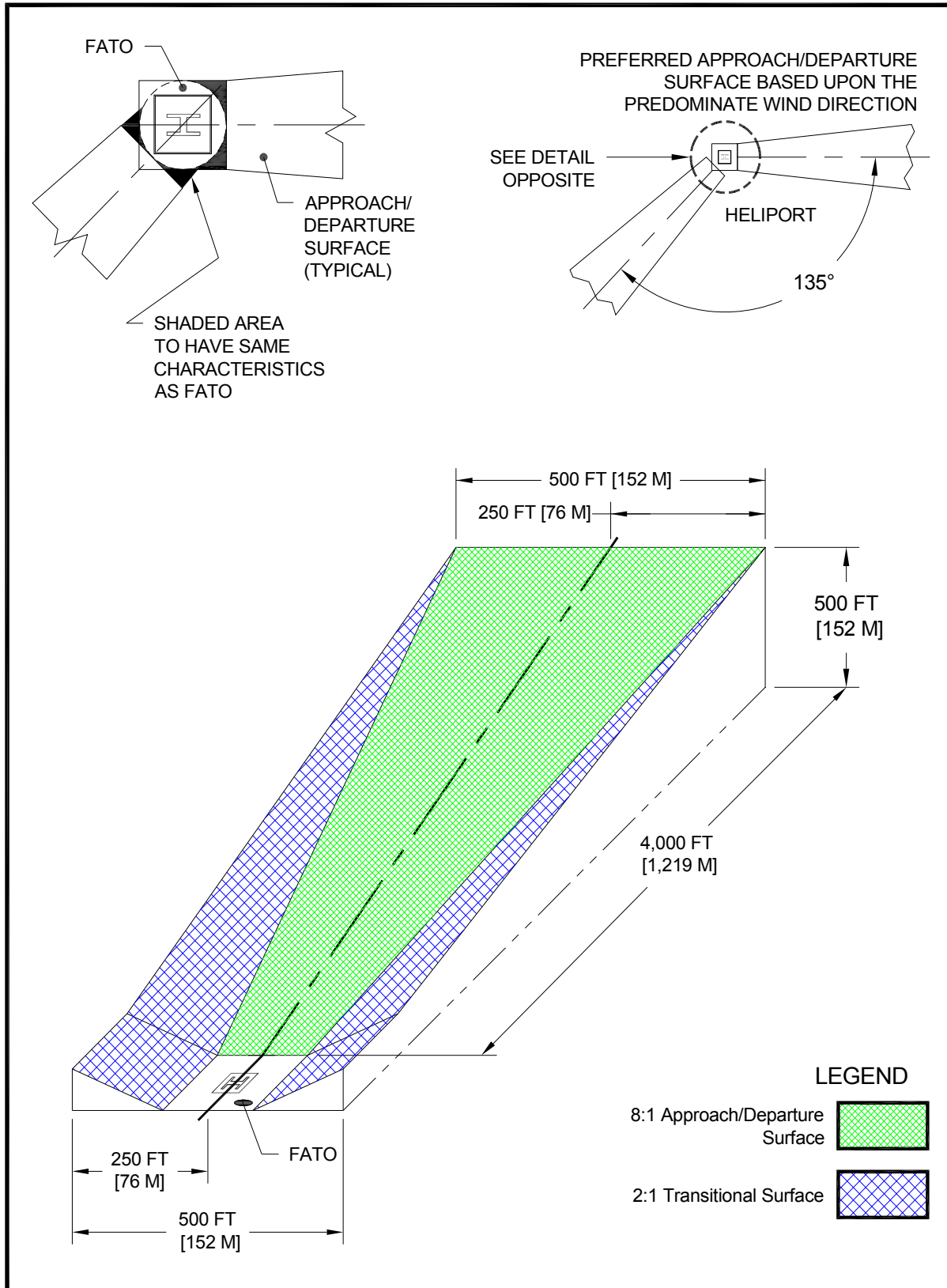
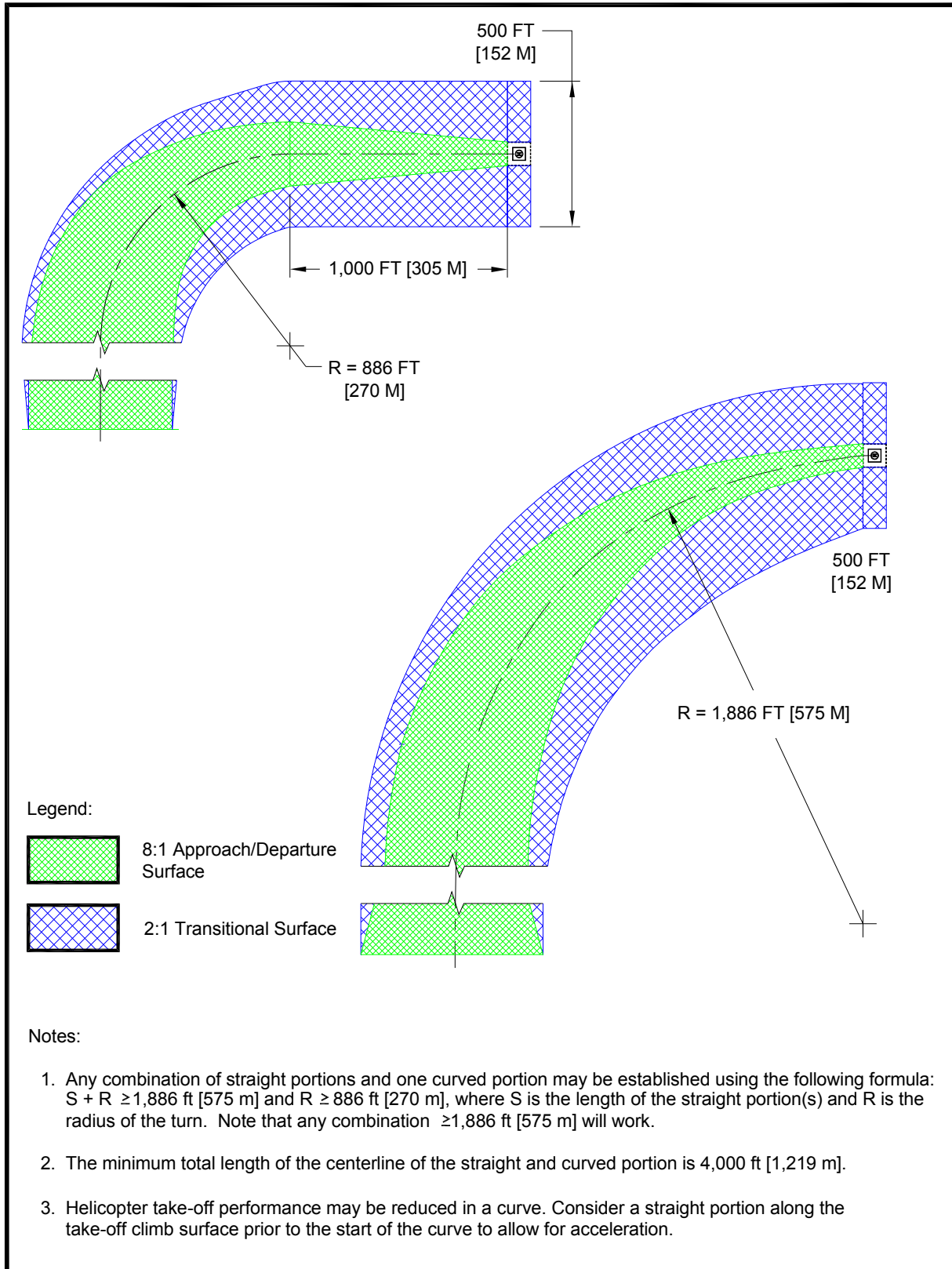


Figure 4-6. VFR Heliport Approach/Departure and Transitional Surfaces: Hospital



**Figure 4-7. Curved Approach/Departure: Hospital**



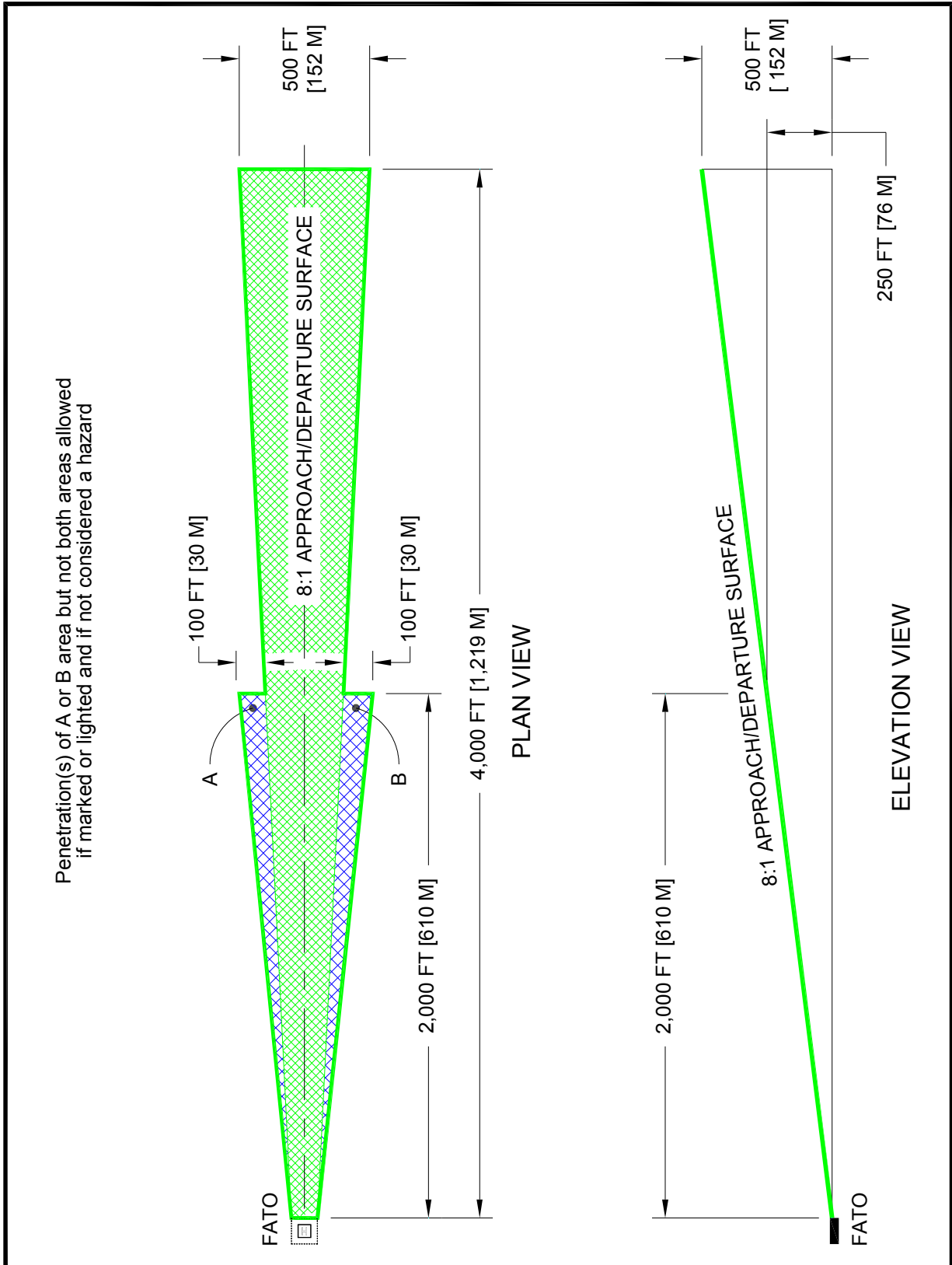
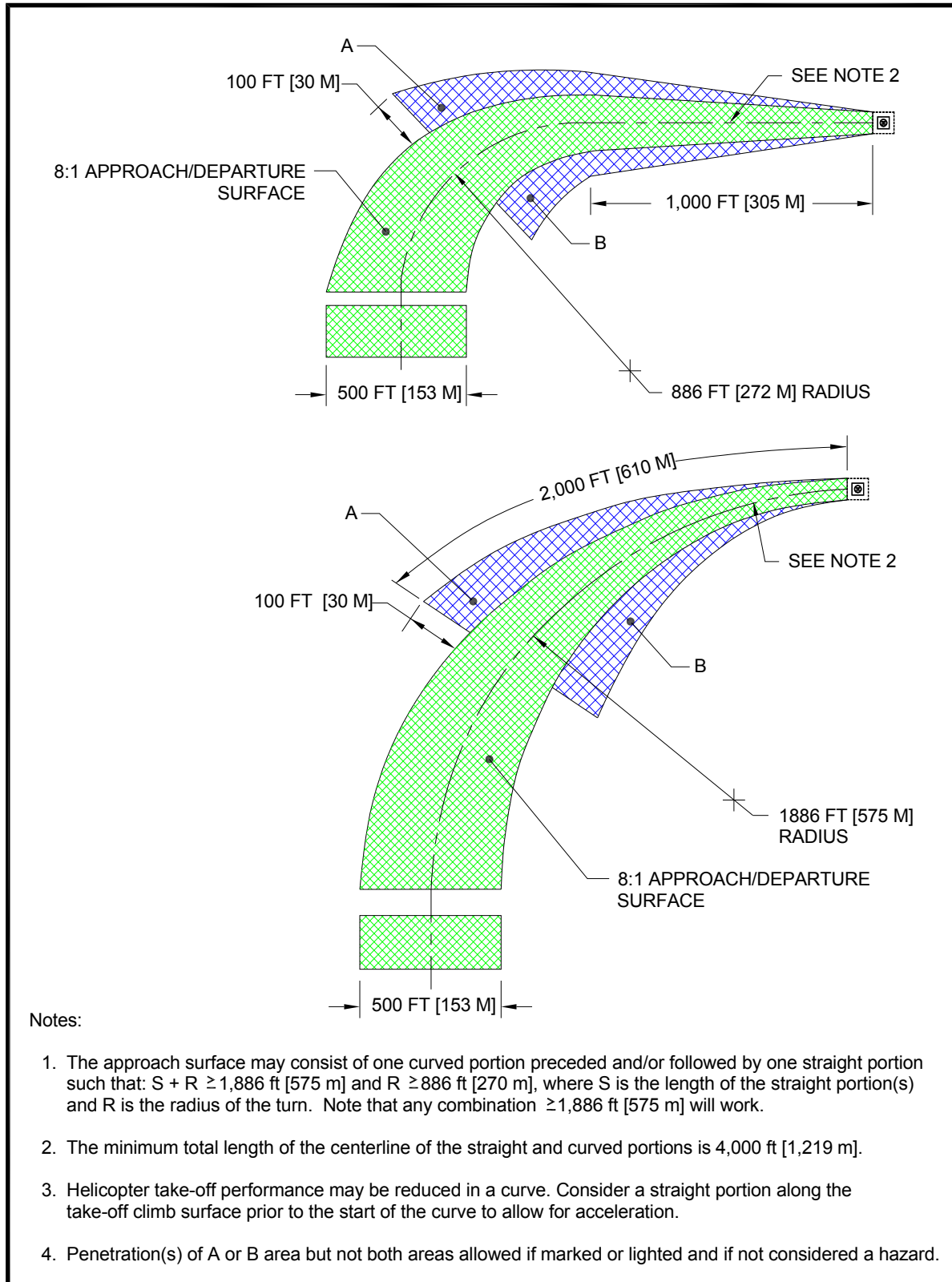


Figure 4-8. VFR Heliport Lateral Extension of the 8:1 Approach / Departure Surface: Hospital



**Figure 4-9. VFR Heliport Lateral Extension of the Curved 8:1 Approach/Departure Surface: Hospital**

**d. Flight path alignment guidance.** As an option, use flight path alignment markings and/or flight path alignment lights (see paragraphs 414 and 415) where it is desirable and practicable to indicate available approach and/or departure flight path direction(s). See Figure 4–10.

**e. Periodic review of obstructions.** Vigilant heliport operators reexamine obstacles in the vicinity of approach/departure paths on at least an annual basis. This reexamination includes an appraisal of the growth of trees near approach and departure paths. Paragraph 111 provides additional information on hazards to air navigation. Pay particular attention to obstacles that need to be marked or lighted. It may be helpful to maintain a list of the GPS coordinates and the peak elevation of obstacles.

**410. Heliport protection zone (HPZ)** The FAA recommends the establishment of an HPZ for each approach/departure surface. The HPZ is the area under the 8:1 approach/departure surface starting at the FATO perimeter and extending out for a distance of 280 feet (85.3 m), as illustrated in Figure 4–11. The HPZ is intended to enhance the protection of people and property on the ground. This is achieved through heliport owner control over the HPZ. Such control includes clearing HPZ areas (and maintaining them clear) of incompatible objects and activities. The FAA discourages residences and places of public assembly in an HPZ. (Churches, schools, hospitals, office buildings, shopping centers, and other uses with similar concentrations of persons typify places of public assembly.) Do not locate hazardous materials, including fuel, in the HPZ.

**411. Wind cone.**

**a. Specification.** Use a wind cone conforming to AC 150/5345-27, Specification for Wind Cone Assemblies, to show the direction and magnitude of the wind. Use a color that provides the best possible color contrast to its background.

**b. Wind cone location.** Locate the wind cone so it provides the pilot with valid wind direction and speed information in the vicinity of the heliport under all wind conditions.

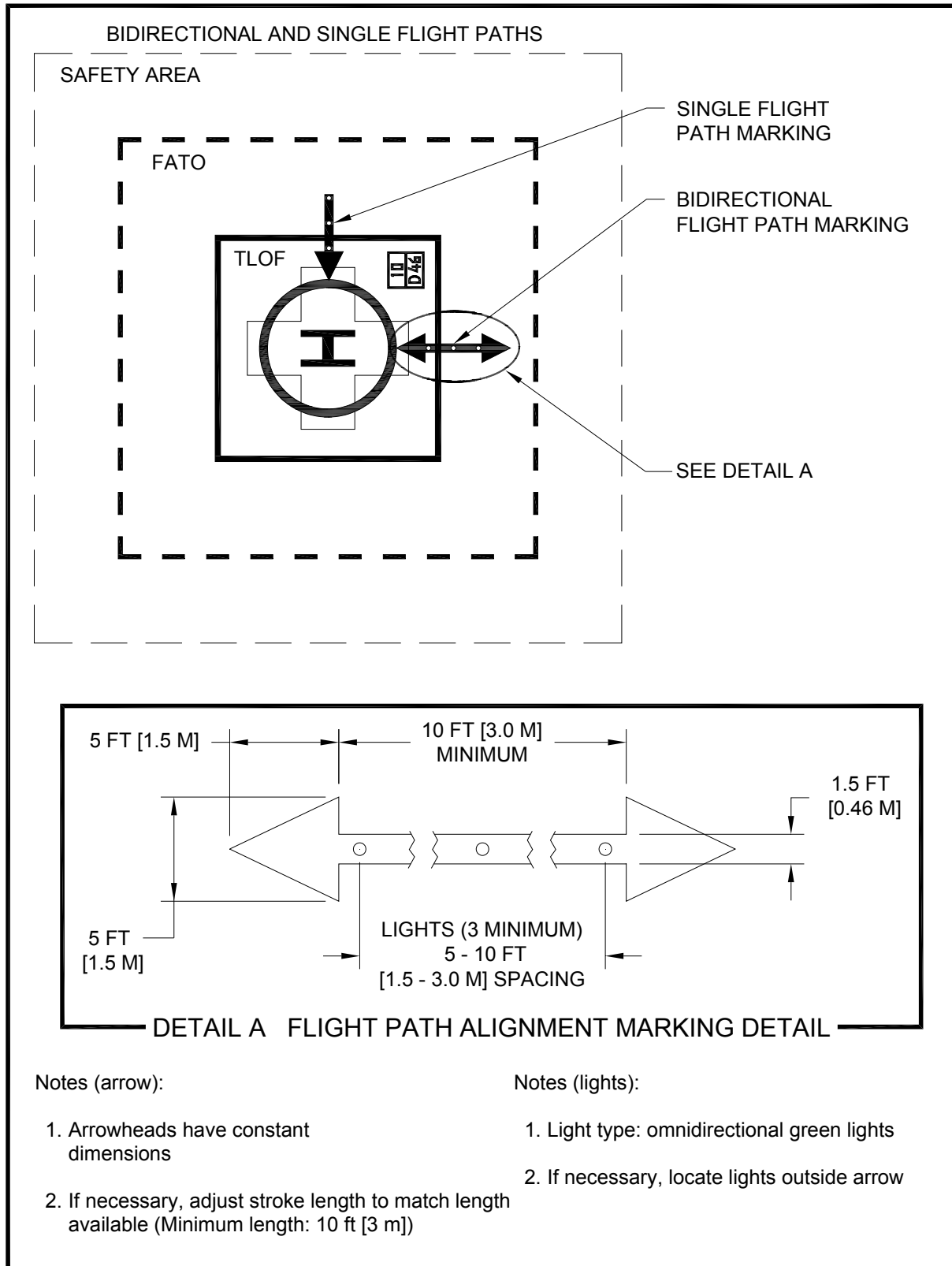
(1) At many landing sites, there may be no single, ideal location for the wind cone. At other sites, it may not be possible to site a wind cone at the ideal location. In such cases, install more than one wind cone in order to provide the pilot with all the wind information needed for safe operations.

(2) Place the wind cone so a pilot on the approach path is able to see it clearly when the helicopter is 500 feet (150 m) from the TLOF.

(3) Place the wind cone so pilots can see it from the TLOF.

(4) To avoid presenting an obstruction hazard, locate the wind cone(s) outside the safety area, so it does not penetrate the approach/departure or transitional surfaces.

**c. Wind cone lighting.** For night operations, illuminate the wind cone, either internally or externally, to ensure it is clearly visible.



**Figure 4–10. Flight Path Alignment Marking and Lights: Hospital**

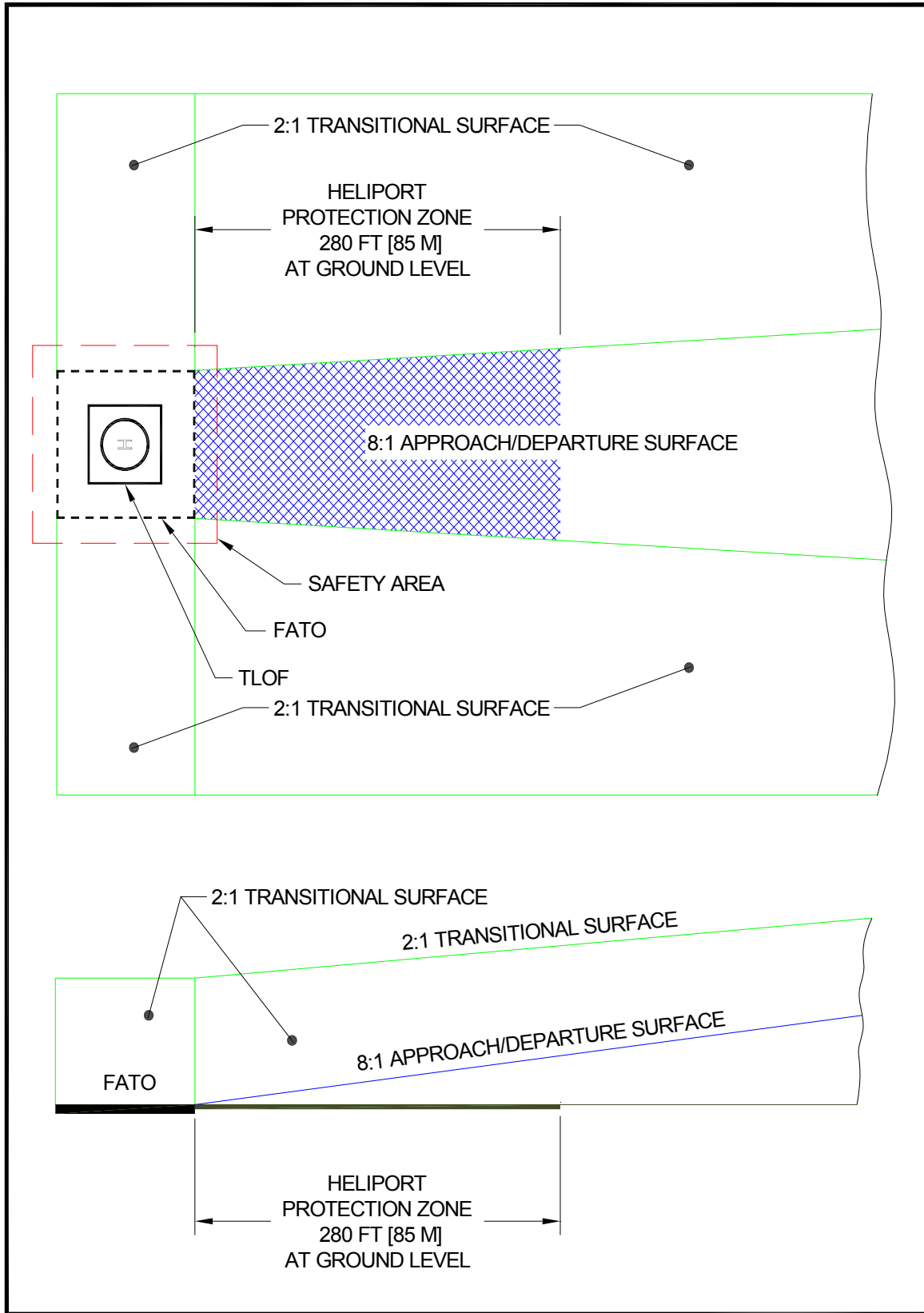


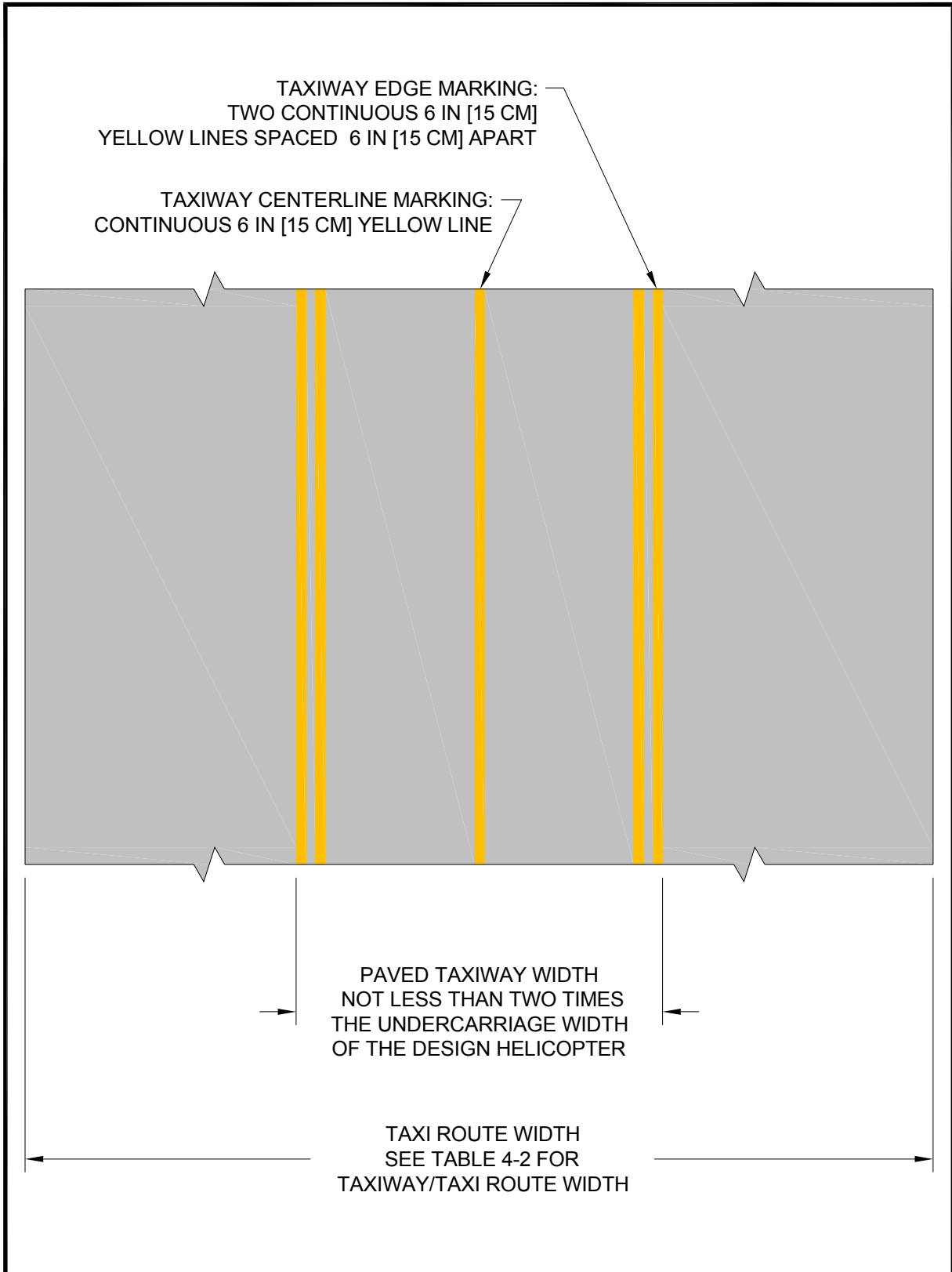
Figure 4-11. Helicopter Protection Zone: Hospital

**412. Taxiways and taxi routes.** Taxiways and taxi routes provide for the movement of helicopters from one part of a landing facility to another. They provide a connecting path between the FATO and a parking area. They also provide a maneuvering aisle within the parking area. A taxi route includes the taxiway plus the appropriate clearances needed on both sides. The relationship between a taxiway and a taxi route is illustrated in Figure 4–12, Figure 4–13, and Figure 4–14. At hospital heliports with no parking or refueling area outside the TLOF(s), it is not necessary to provide a taxi route or taxiway.

**a. Taxiway/taxi route widths.** The dimensions of taxiways and taxi routes are a function of helicopter size, taxiway/taxi route marking, and type of taxi operations (ground taxi versus hover taxi). These dimensions are defined in Table 4-2. Normally, the requirement for hover taxi dictates the taxiway/taxi route widths. However, when the fleet comprises a combination of large ground taxiing helicopters and smaller air taxiing helicopters, the larger aircraft may dictate the taxiway/taxi route widths. If wheel-equipped helicopters taxi with wheels not touching the surface, design the facility with hover taxiway widths rather than ground taxiway widths. Where the visibility of the centerline marking cannot be guaranteed at all times, such as locations where snow or dust commonly obscure the centerline marking and it is not practical to remove it, determine the minimum taxiway/taxi route dimensions as if there was no centerline marking.

**b. Surfaces.** For ground taxiways, provide a surface that is portland cement concrete, asphalt, or a surface, such as turf, stabilized in accordance with the standards of Item P-217 of AC 150/5370-10. For unpaved portions of taxiways and taxi routes, provide a turf cover or treat the surface in some way to prevent dirt and debris from being raised by a taxiing helicopter's rotor wash.

**c. Gradients.** Taxiway and taxi route gradient standards are defined in Chapter 7.



**Figure 4-12. Taxiway/Taxi Route Relationship – Paved Taxiway: Hospital**

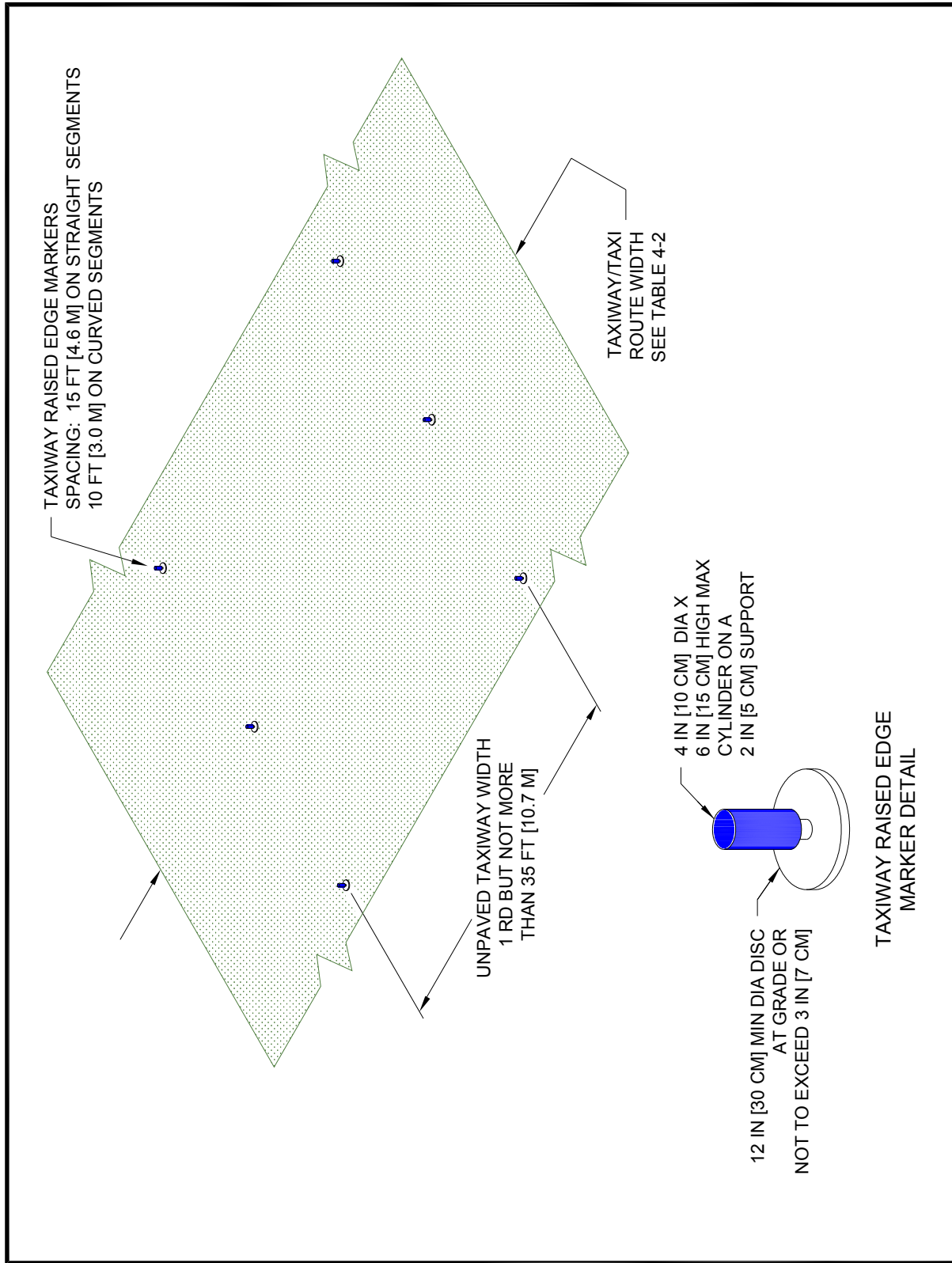
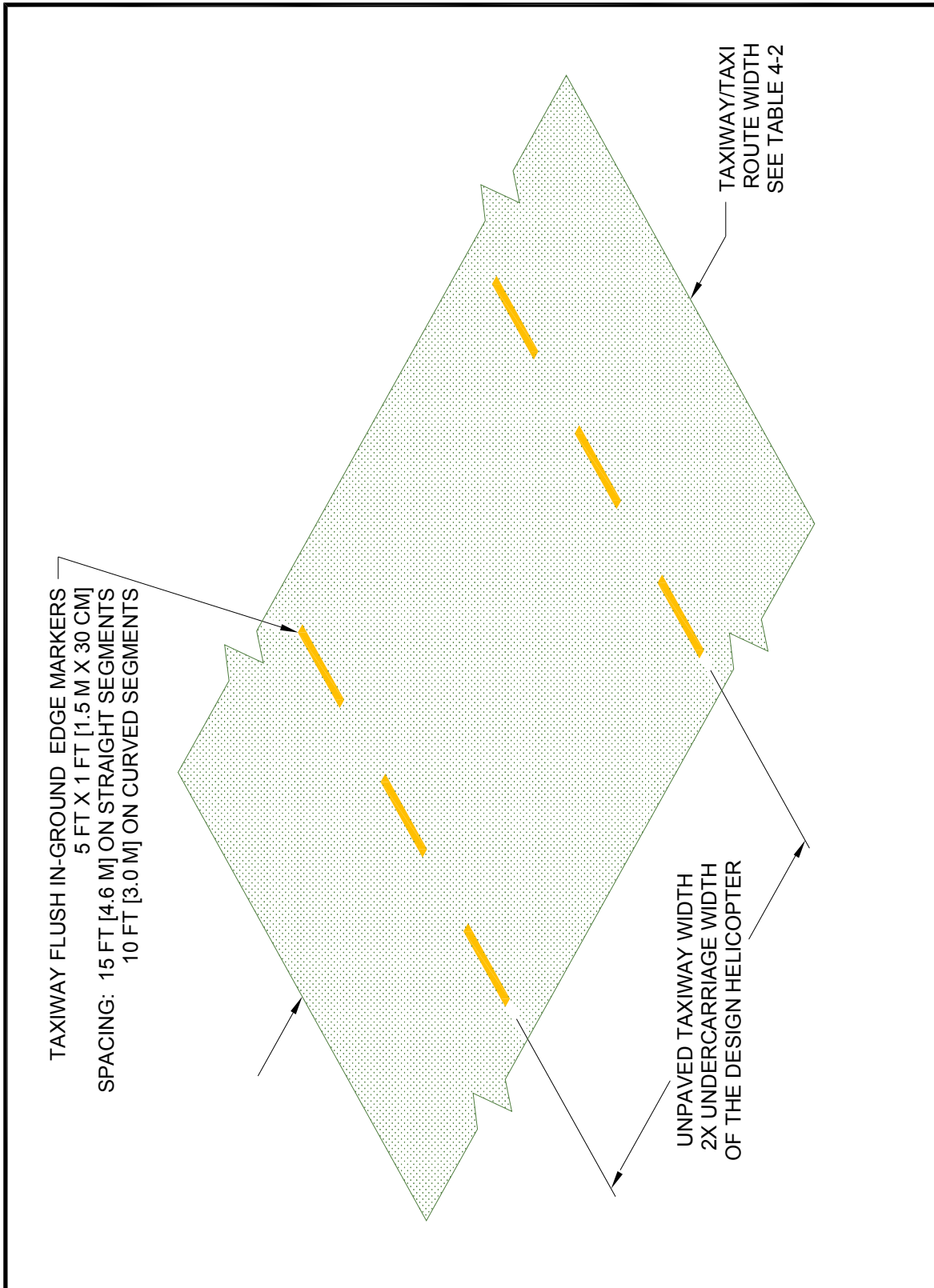


Figure 4-13. Taxiway/Taxi Route Relationship –  
Unpaved Taxiway with Raised Edge Markers: Hospital





**Figure 4-14. Taxiway/Route Relationship –  
Unpaved Taxiway with Flush Edge Markers: Hospital**

**Table 4-2. Taxiway / Taxi Route Dimensions – Hospital Heliports**

Taxiway (TW) Type	Minimum Width of Paved Area	Centerline Marking Type	TW Edge Marking Type	Lateral Separation Between TW Edge Markings	Total Taxi Route Width
Ground Taxiway	2 x UC	Painted	Painted	2 x UC	1½ RD
			Elevated	1 RD but not greater than 35 ft (10.7 m)	
	Unpaved but stabilized for ground taxi	None	Flush	2 x UC	
			Elevated	1 RD but not greater than 35 ft (10.7 m)	
Hover Taxiway	2 x UC	Painted	Painted	2 x UC	2 RD
	Unpaved	None	Elevated or Flush	1 RD but not greater than 35 ft (10.7 m)	

RD: rotor diameter of the design helicopter  
 TW: taxiway  
 UC: undercarriage length or width (whichever is greater) of the design helicopter

**413. Helicopter parking.** If more than one helicopter at a time is expected at a heliport, design the facility with an area designated for parking helicopters. The size of this area depends on the number and size of specific helicopters to be accommodated. It is not necessary that every parking position accommodate the design helicopter. Design individual parking positions to accommodate the helicopter size and weight expected to use the parking position at the facility. However, use the design helicopter to determine the separation between parking positions and taxi routes. Use the larger helicopter to determine the separation between parking positions intended for helicopters of different sizes. Design the parking positions to support the static loads of the helicopter intended to use the parking area. Design parking areas as one large, paved apron or as individual, paved parking positions. Ground taxi turns of wheeled helicopters are significantly larger than a hover turn. Consider the turn radius of helicopters when designing taxi intersections and parking positions for wheeled helicopters. Design heliport parking areas so helicopters will be parked in an orientation that keeps the “avoid areas” around the tail rotors (see Figure 4–18, Figure 4–19, and Figure 4–20) clear of passenger walkways.

**a. Location.** Do not locate aircraft parking areas under an approach/departure surface. However, as an option, allow aircraft parking areas under the transitional surfaces.

(1) For “turn around” parking positions, locate the parking position to provide a minimum distance between the tail rotor arc and any object, building, safety area, or other parking position. The minimum distance is 10 feet (3 m) for ground taxi operations and the greater of 10 feet (3 m) or 1/3 RD for hover taxi operations. See Figure 4–15 and Figure 4–18.

(2) For “taxi-through” and “back-out” parking positions, locate the parking position to provide a minimum distance between the main rotor circle and any object, building, safety area, or other parking position. The minimum distance is 10 feet (3 m) for ground taxi operations and the greater of 10 feet (3 m) or 1/3 RD for hover taxi operations. See Figure 4–15, Figure 4–17, and Figure 4–19.

(3) Locate the parking position to provide a minimum distance between the main rotor circle and the edge of any taxi route. Design parking positions such that the helicopter taxis through, turns around, or backs out to depart. The minimum distance is 1/3 RD for “turn around” and “taxi through” parking areas, and 1/2 RD for “back-out” parking areas. See Figure 4–15, Figure 4–16, and Figure 4–17.

**b. Parking position sizes** are dependent upon the helicopter size. The clearance between parking positions are dependent upon the type of taxi operations (ground taxi or hover taxi) and the intended paths for maneuvering in and out of the parking position. The more demanding requirement will dictate what is required at a particular site. Usually, the parking area requirements for skid-equipped helicopters will be

the most demanding. However, when the largest helicopter is a very large, wheeled aircraft (for example, the S-61), and the skid-equipped helicopters are all much smaller, the parking requirements for wheeled helicopters may be the most demanding. If wheel-equipped helicopters taxi with wheels not touching the surface, design parking areas based on hover taxi operations rather than ground taxi operations.

(1) If all parking positions are the same size, design them to be large enough to accommodate the largest helicopter that will park at the heliport.

(2) When there is more than one parking position, as an option design the facility with parking positions of various sizes and at least one position to accommodate the largest helicopter that will park at the heliport. Design other parking positions to be smaller, designed for the size of the individual or range of individual helicopters parking at that position. Figure 4–20 also provides guidance on parking position identification, size, and weight limitations.

(3) “Taxi-through” parking positions are illustrated in Figure 4–15. When using this design for parking positions, the heliport owner and operator take steps to ensure all pilots are informed that “turn-around” or “back-up” departures from the parking position are not permitted.

(4) “Turn-around” parking positions are illustrated in Figure 4–17.

(5) “Back-out” parking positions are illustrated in Figure 4–17. When using this design for parking positions, design the adjacent taxiway to accommodate hover taxi operations so the width of the taxiway will be adequate to support “back-out” operations.

**c. Parking pads.** When partially paving a parking area, design the smallest dimension of the paved parking pad to be a minimum of two times the maximum dimension (length or width, whichever is greater) of the undercarriage or the RD, whichever is less, of the largest helicopter that will use this parking position. Place the parking pad in the center of the parking position circle.

**d. Walkways.** At parking positions, provide marked walkways where practicable. Design the pavement to drain away from walkways.

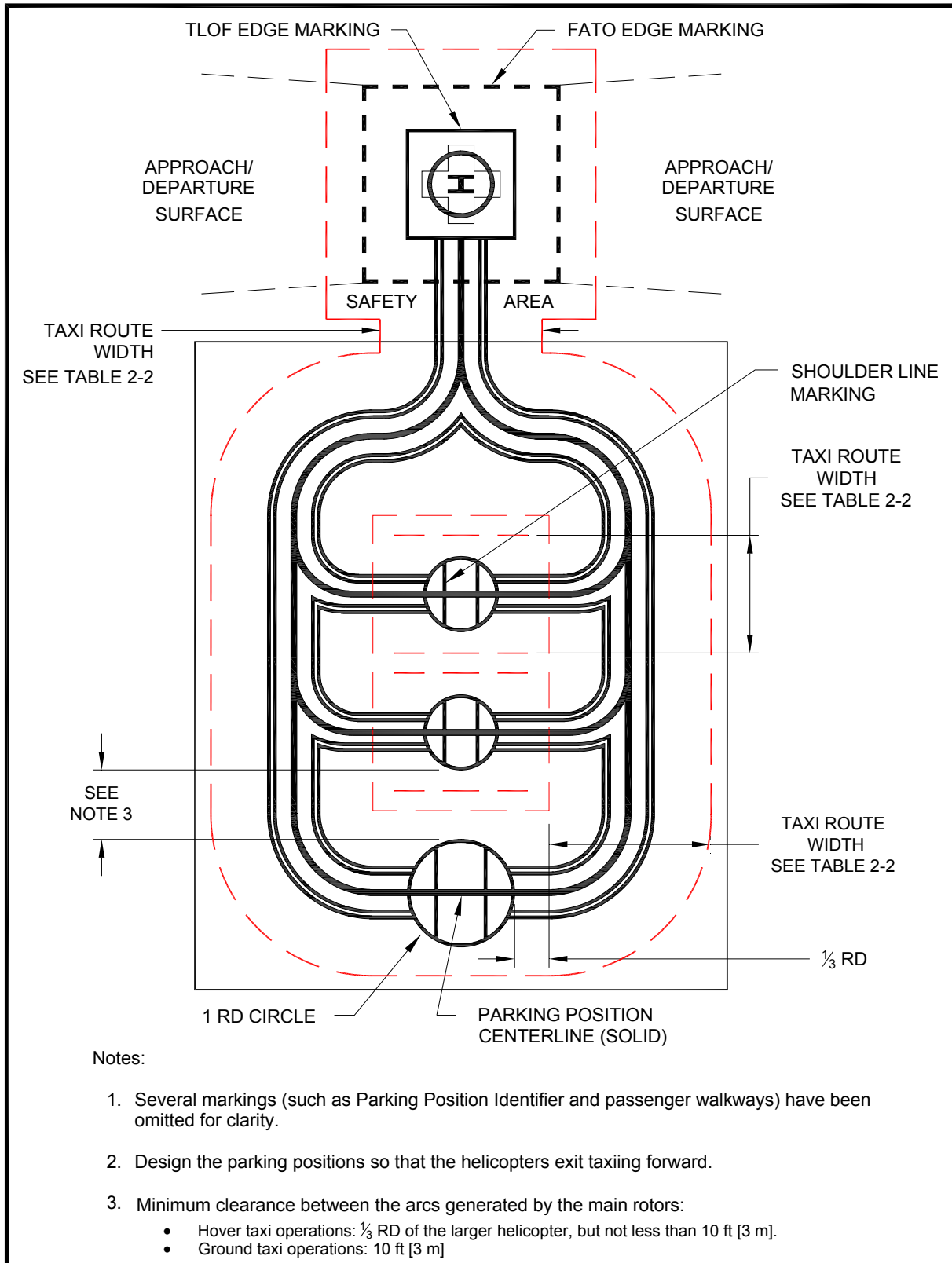
**e. Fueling.** Design the facility to allow fueling with the use of a fuel truck or a specific fueling area with stationary fuel tanks.

(1) Various federal, state, and local requirements for petroleum handling facilities apply to systems for storing and dispensing fuel. Find guidance in AC 150/5230-4, Aircraft Fuel Storage, Handling, and Dispensing on Airports. Additional information may be found in various National Fire Protection Association (NFPA) publications. For more reference material, see Appendix D.

(2) Do not locate fueling equipment in the TLOF, FATO, or safety area. Design and mark separate fueling locations to minimize the potential for helicopters to collide with the dispensing equipment. Design fueling areas so there is no object tall enough to be hit by the main or tail rotor blades within a distance of RD from the center point of the position where the helicopter would be fueled (providing  $\frac{1}{2}$  RD clearance from the rotor tips). If this is not practical at an existing facility, install long fuel hoses.

(3) **Lighting.** Light the fueling area if night fueling operations are contemplated. Ensure any light poles do not constitute an obstruction hazard.

**f. Tiedowns.** Install recessed tiedowns to accommodate extended or overnight parking of based or transient helicopters. If tiedowns are provided, recess them so as not to be a hazard to helicopters. Ensure any depression associated with the tiedowns is of a diameter not greater than  $\frac{1}{2}$  the width of the smallest helicopter landing wheel or landing skid anticipated to be operated on the heliport surface. In addition, provide storage for tiedown chocks, chains, cables and ropes off the heliport surface to avoid fouling landing gear. Find guidance on recessed tiedowns in AC 20-35, Tiedown Sense.



**Figure 4-15. Parking Area Design –  
“Taxi-through” Parking Positions: Hospital**

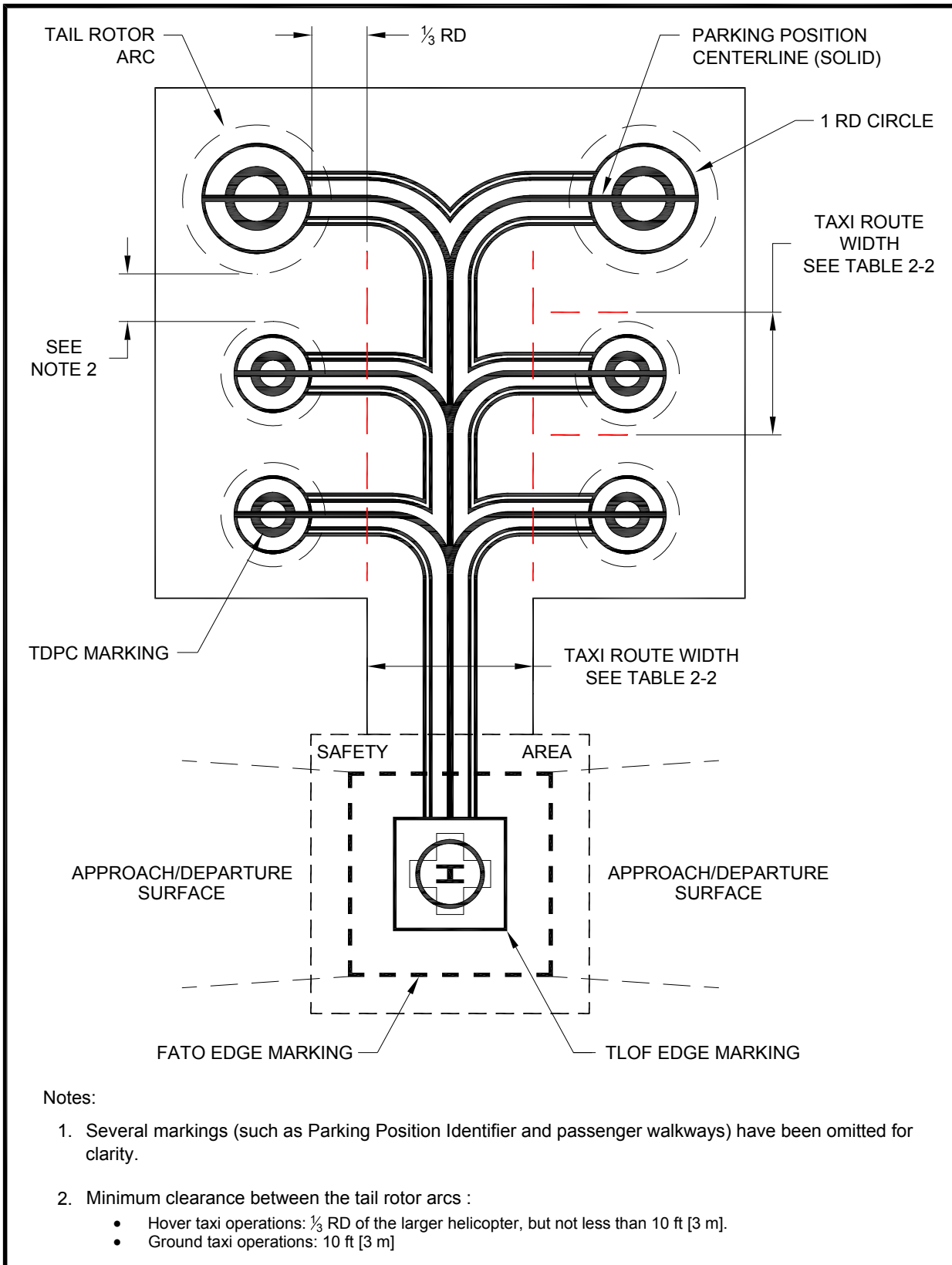


Figure 4-16. Parking Area Design – “Turn-around” Parking Positions: Hospital

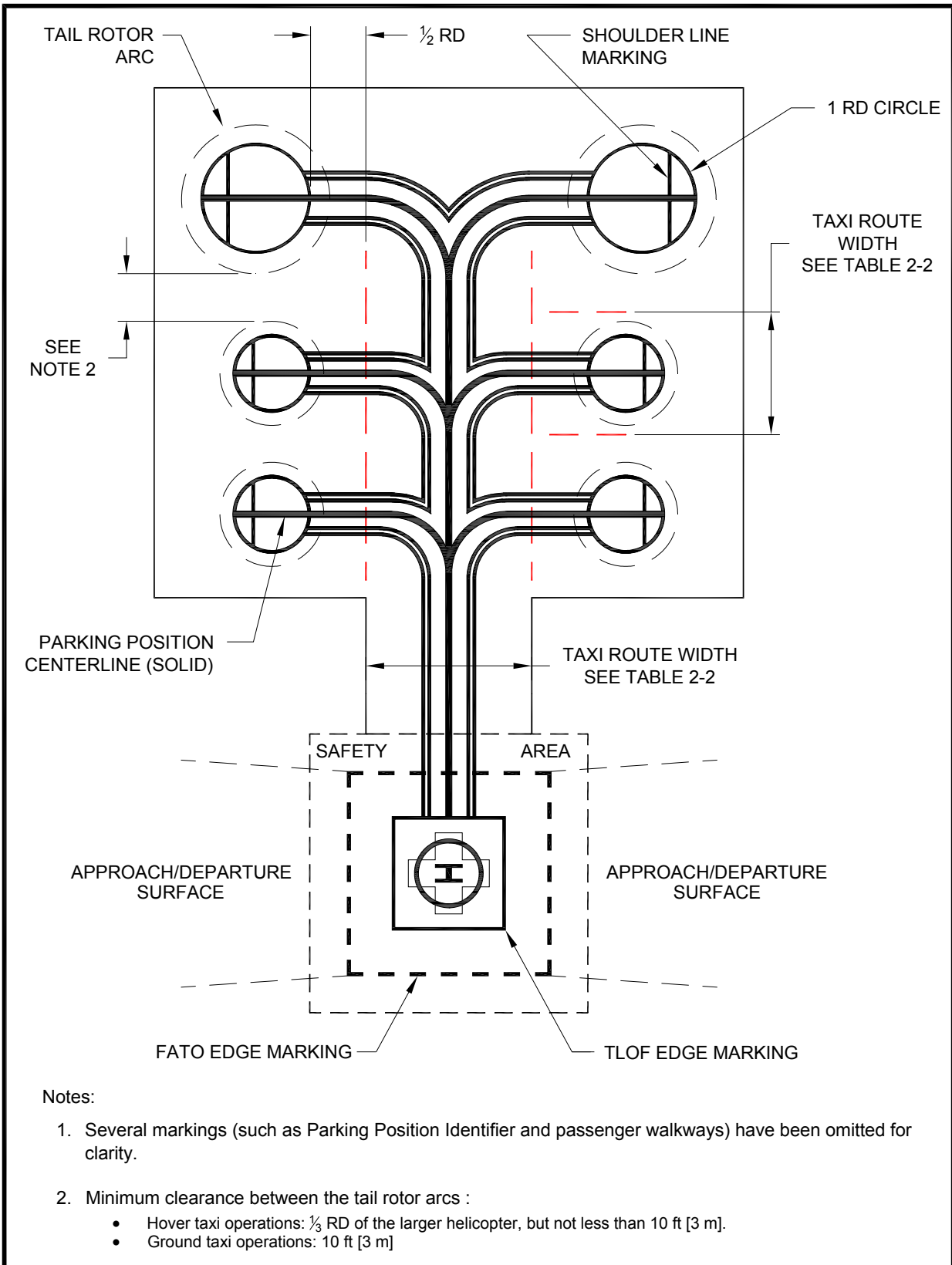


Figure 4–17. Parking Area Design – “Back-out” Parking Positions: Hospital

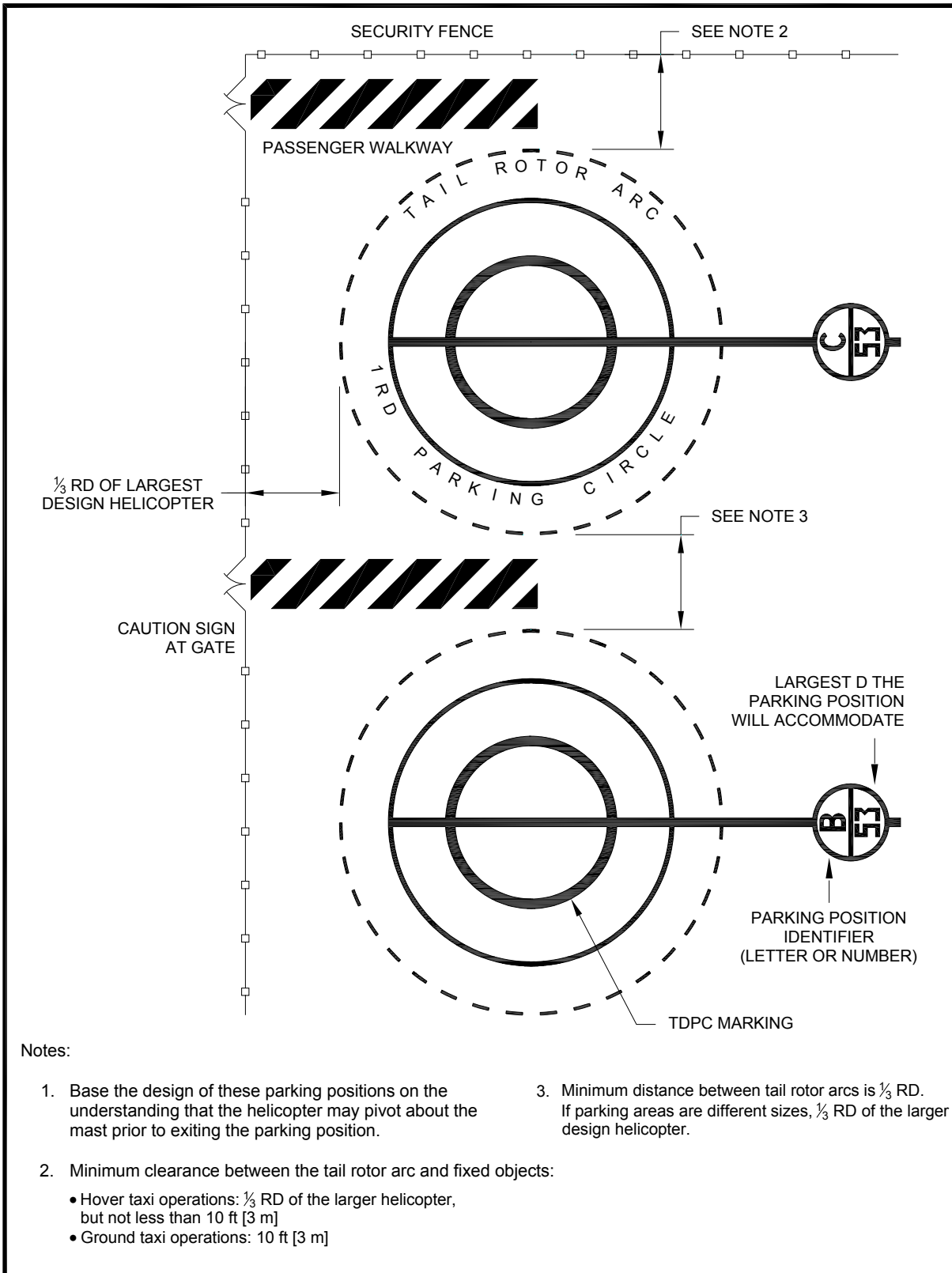


Figure 4-18. "Turn-around" Helicopter Parking Position Marking: Hospital

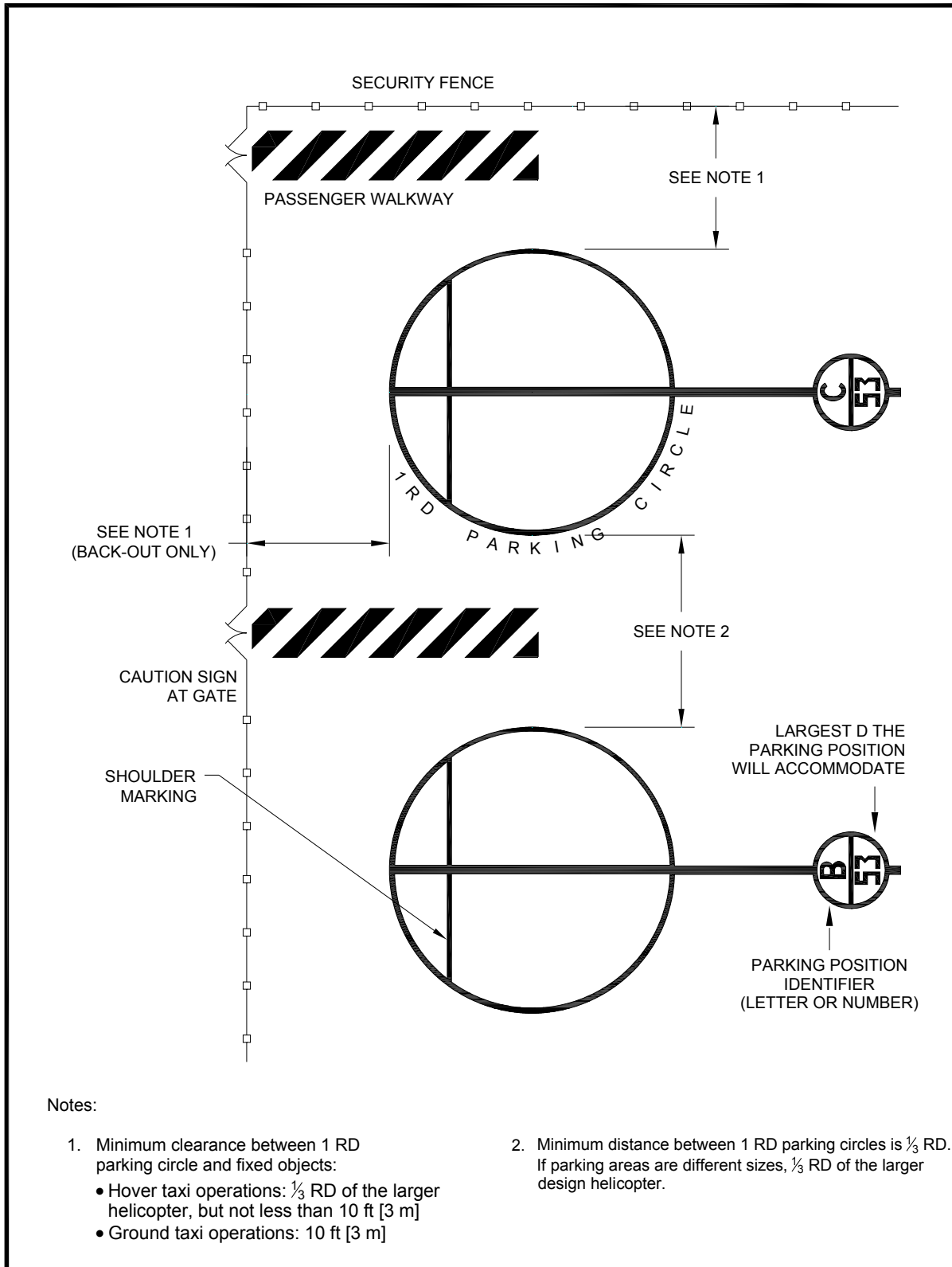


Figure 4-19. "Taxi-through" and "Back-out" Helicopter Parking Position Marking: Hospital



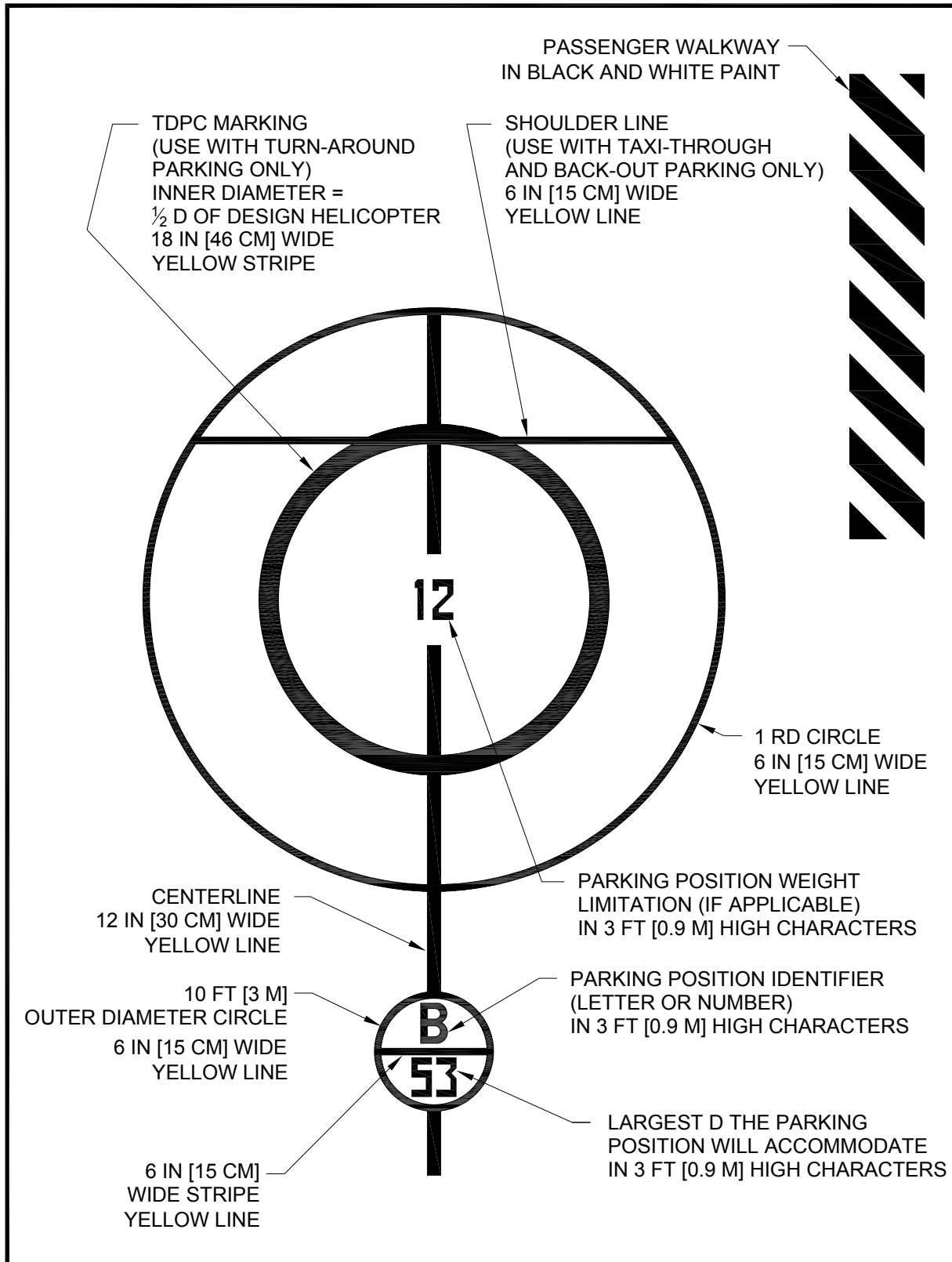


Figure 4-20. Parking Position Identification, Size, and Weight Limitations: General Aviation

**414. Heliport markers and markings.** Markers and/or surface markings identify the facility as a heliport. Use paint or preformed material for surface markings (see AC 150/5370-10, Item P-620, for specifications for paint and preformed material). Reflective paint and reflective markers may also be used, though overuse of reflective material can be blinding to a pilot using landing lights. As an option, outline lines/markings with a 6-inch wide (15 cm) line of a contrasting color to enhance conspicuity. Place markings that define the edges of a TLOF, FATO, taxiway or apron within the limits of those areas. Use the following markers and markings:

**a. Hospital heliport identification marking.** The identification marking identifies the location as a hospital heliport, marks the TLOF and provides visual cues to the pilot.

**(1) Standard hospital heliport identification symbol.** Mark the TLOF with a red “H” in a white cross. The minimum height of the “H” is 10 feet (3 m). Locate the “H” in the center of the TLOF and orient it on the axis of the preferred approach/departure path. Place a 12-inch wide red bar under the “H” when it is necessary to distinguish the preferred approach/departure direction. The proportions and layout of the standard hospital heliport identification symbol are illustrated in Figure 4–21. Increase the dimensions of the “H” and cross proportionately for larger TLOFs.

**(2) Alternative marking.** As an alternative to the standard marking, use a red “H” with a white 6-inch (15 cm) wide border within a red cross with a 12 inch (30 cm) wide white border and a surrounding red TLOF. Where it is impractical to paint the whole TLOF red, paint the TLOF so the minimum dimension (length, width, or diameter) of the outer red area is equal to the RD of the design helicopter but not less than 40 feet (12.2 m). Figure 4–22 illustrates this alternative marking. Increase the dimensions of the “H” and cross proportionately for larger TLOFs.

**(3) Winter operations.** In winter weather at a heliport with a dark TLOF surface, the marking in Figure 4–22 will absorb more heat from the sun and more readily melt residual ice and snow. In contrast, the white area in Figure 4–21 is more likely to be icy during winter weather. Consequently, in areas that experience ice and snow, use the markings in Figure 4–22 for unheated TLOFs.

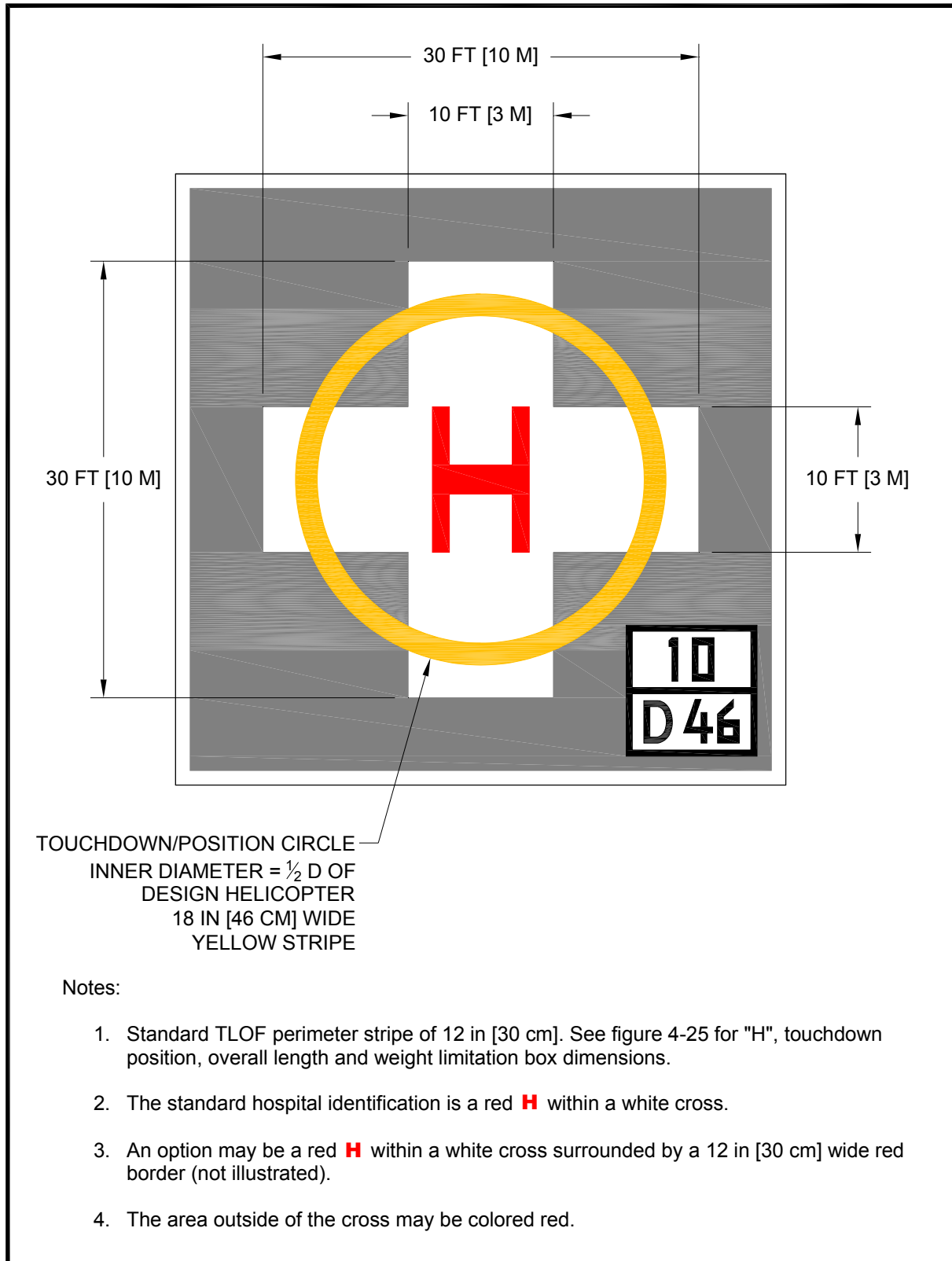
**b. TLOF markings.**

**(1) TLOF perimeter marking.** Mark the TLOF perimeter with markers and/or lines. See paragraph 408 and Table 4-1 for guidance on increasing the size of the safety area if the TLOF perimeter is not marked.

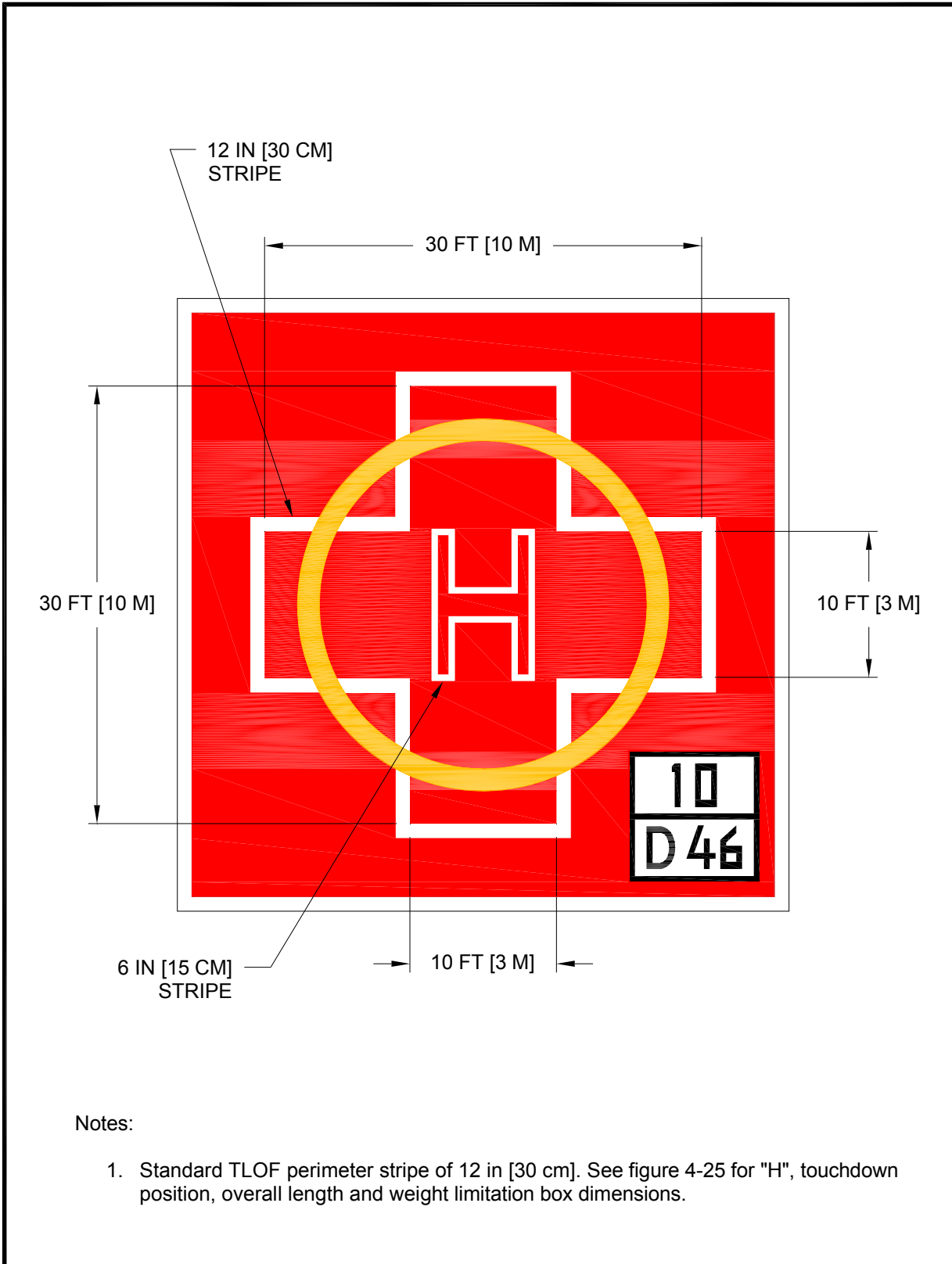
**(a) Paved TLOFs.** Define the perimeter of a paved or hard surfaced TLOF with a continuous, 12-inch-wide (30 cm), white line. See Figure 4–23.

**(b) Unpaved TLOFs.** Define the perimeter of an unpaved TLOF with a series of 12-inch-wide (30 cm), flush, in-ground markers, each approximately 5 feet (1.5 m) in length with end-to-end spacing of not more than 6 inches (15 cm). See Figure 4–24.

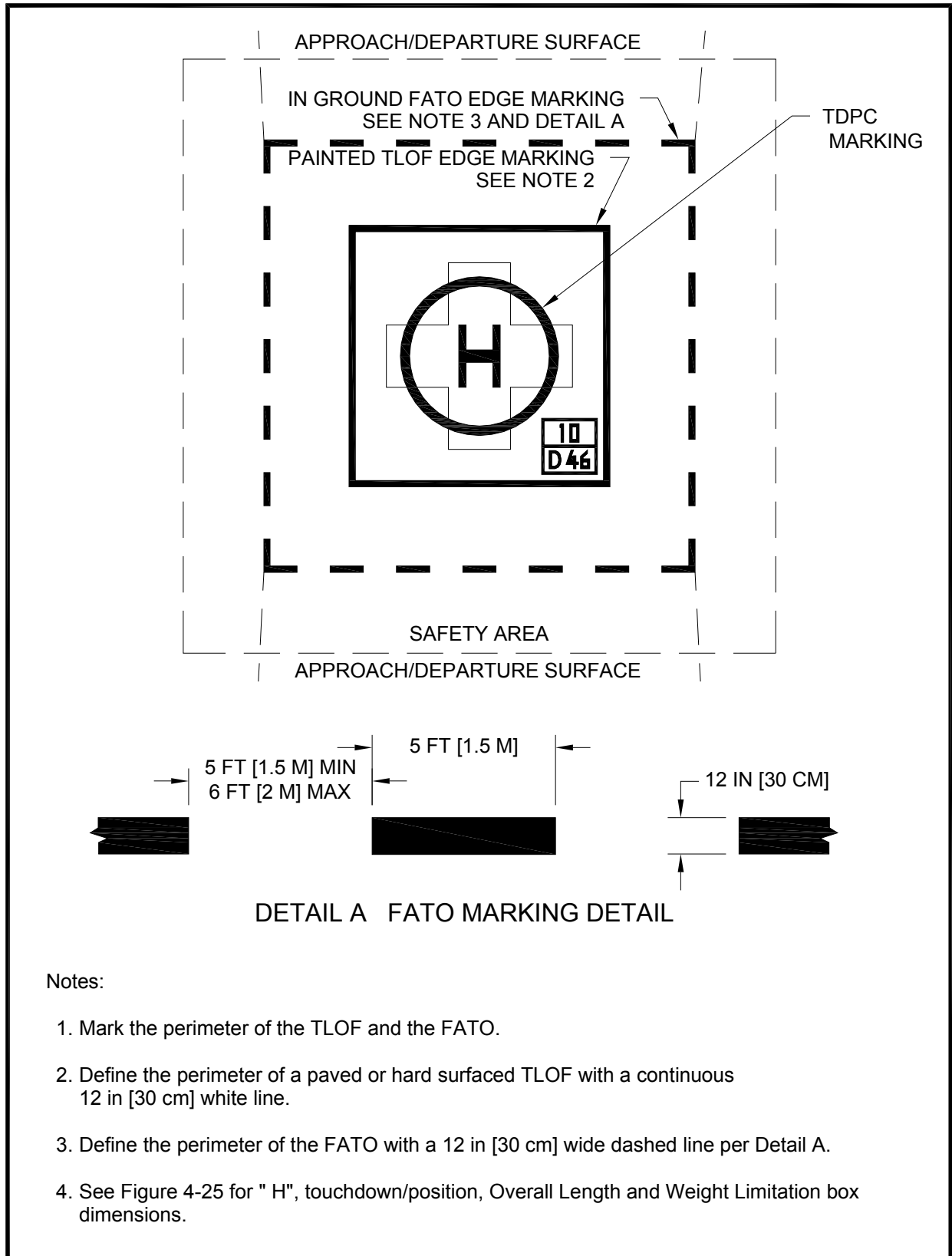
**(2) Touchdown/positioning circle (TDPC) marking.** Use an optional TDPC marking to provide guidance to allow a pilot to touch down in a specific position on paved surfaces. When the pilot’s seat is over the marking, the undercarriage will be inside the LBA, and all parts of the helicopter will be clear of any obstacle by a safe margin. A TDPC marking is a yellow circle with an inner diameter of  $\frac{1}{2}$  D and a line width of 18 inches (46 cm). Locate a TDPC marking in the center of a TLOF. See Figure 4–21, Figure 4–22, and Figure 4–23.



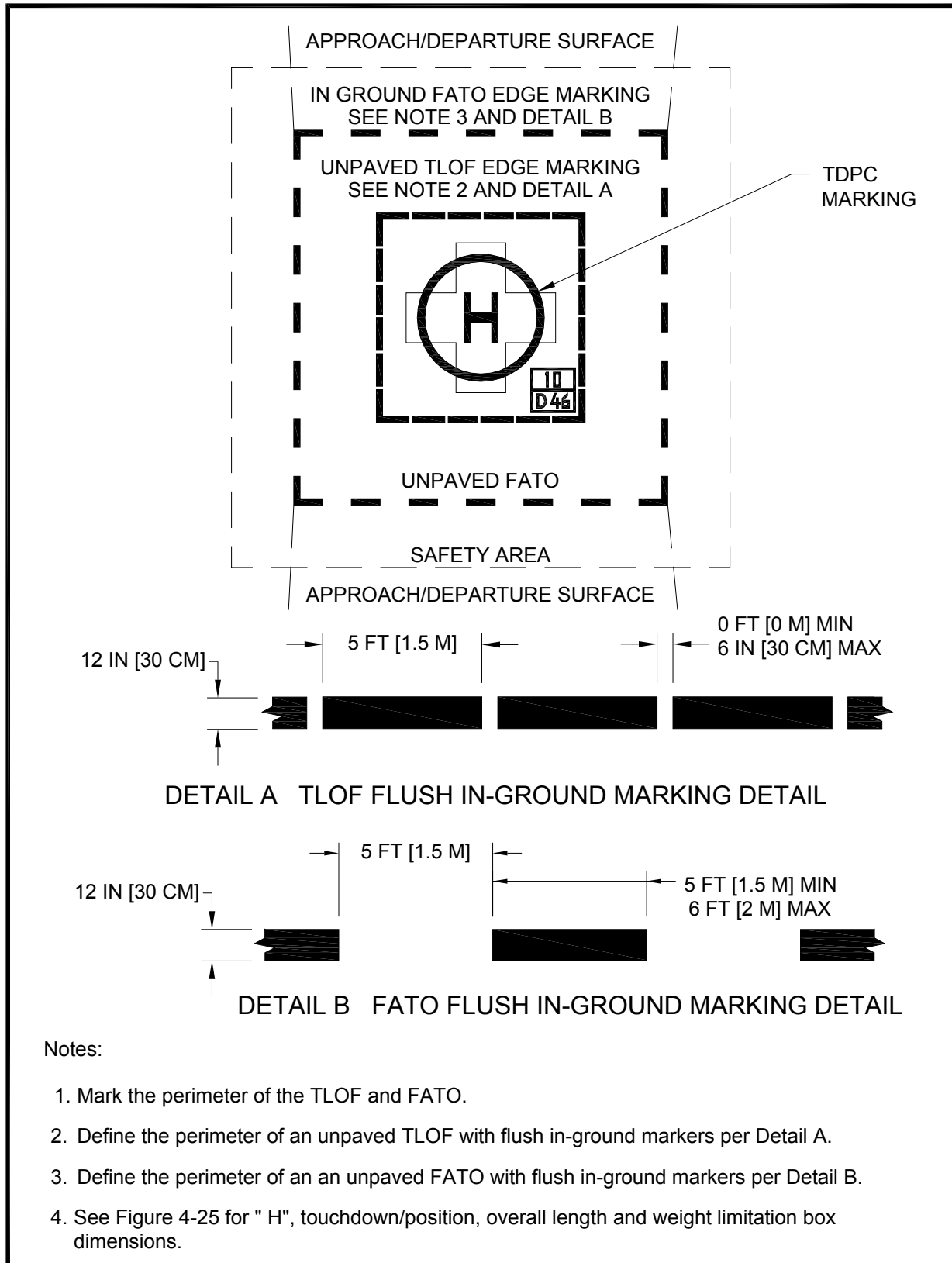
**Figure 4–21. Standard Hospital Heliport Identification Symbols: Hospital**



**Figure 4–22. Alternative Hospital Heliport Identification Symbols: Hospital**



**Figure 4-23. Paved TLOF/Paved FATO – Paved TLOF/Unpaved FATO – Marking: Hospital**



**Figure 4-24. Unpaved TLOF/Unpaved FATO – Marking: Hospital**

**(3) TLOF size and weight limitations.** Mark the TLOF to indicate the length and weight of the largest helicopter it will accommodate, as shown in Figure 4–25. Place these markings in a box in the lower right-hand corner of the TLOF, or on the right-hand side of the “H” of a circular TLOF, when viewed from the preferred approach direction. The box is 5 feet (1.5 m) square. The numbers are 18” (46 cm) high. If necessary, interrupt the TDPC marking with this marking. (See Figure C–2.) The numbers are black with a white background. This marking is optional at a TLOF with a turf surface.

**(a) TLOF size limitation.** This number is the length (D) of the largest helicopter the TLOF will accommodate, as shown in Figure 4–25. The marking consists of the letter “D” followed by the dimension in feet. Do not use metric equivalents used for this purpose. Center this marking in the lower section of the TLOF size/weight limitation box.

**(b) TLOF weight limitations.** If a TLOF has limited weight-carrying capability, mark it with the maximum takeoff weight of the design helicopter, in units of thousands of pounds, as shown in Figure 4–25. Do not use metric equivalents for this purpose. Center this marking in the upper section of a TLOF size/weight limitation box. If the TLOF does not have a weight limit, add a diagonal line extending from the lower left hand corner to the upper right hand corner to the upper section of the TLOF size/weight limitation box.

**c. Extended pavement/structure markings.** As an option at hospital heliports, increase the pavement or structure without a corresponding increase in the length and width or diameter of the FATO to accommodate pedestrians and/or support operations. Whether or not this increased area is part of the LBA, mark the pavement or structure outside the TLOF with 12-inch-wide (30 cm) diagonal black and white stripes. See Figure 4–26 for marking details.

**d. FATO markings.**

**(1) FATO perimeter marking.** Define the perimeter of a load-bearing FATO with markers and/or lines. Do not mark the FATO perimeter if any portion of the FATO is not a load-bearing surface. In such cases, mark the TLOF perimeter (see paragraph 414.)

**(a) Paved FATO.** Define the perimeter of a paved load-bearing FATO with a 12-inch-wide (30 cm) dashed white line. Use marking segments approximately 5 feet (1.5 m) in length, and with end-to-end spacing of approximately 5 feet (1.5 m) to define the corners of the FATO and the perimeter. See Figure 4–23.

**(b) Unpaved FATO.** Define the perimeter of an unpaved load-bearing FATO with 12-inch-wide (30 cm), flush, in-ground markers. Use marking segments approximately 5 feet (1.5 m) in length, and with end-to-end spacing of approximately 5 feet (1.5 m) to define the corners of the FATO and the perimeter. See Figure 4–23 and Figure 4–24.

**e. Flight path alignment guidance marking.** An optional flight path alignment guidance marking consists of one or more arrows to indicate the preferred approach/departure direction(s). Place it on the TLOF, FATO and/or safety area surface as shown in Figure 4–10. The shaft of the arrow(s) is 18 inches (50 cm) in width and at least 10 feet (3 m) in length. When combined with a flight path alignment guidance lighting system described in paragraph 415, it takes the form shown in Figure 4–10, which includes scheme for marking the arrowheads. Use a color that provides good contrast against the background color of the surface on which they are marked. An arrow pointing toward the center of the TLOF depicts an approach direction. An arrow pointing away from the center of the TLOF depicts a departure direction. In the case of a flight path limited to a single approach direction or a single takeoff direction, the arrow marking is unidirectional. In the case of a heliport with only a bidirectional approach/takeoff flight path available, the arrow marking is bidirectional.

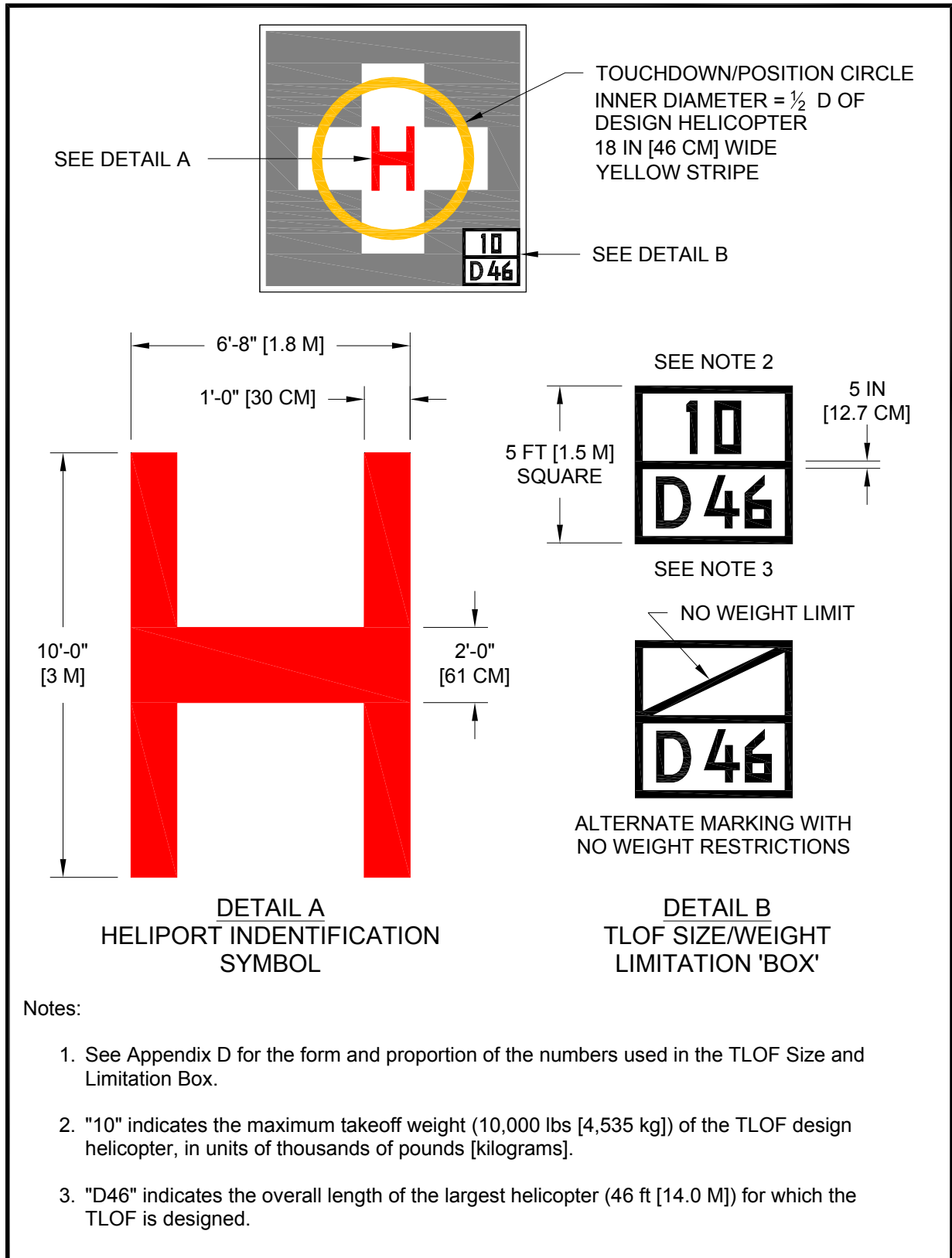


Figure 4-25. TLOF Size and Weight Limitations: Hospital





**Figure 4–26. Extended Pavement or Structure Marking: Hospital**

**f. Taxi route and taxiway markings.**

**(1) Paved taxiway markings.** Mark the centerline of a paved taxiway with a continuous 6-inch (15 cm) yellow line. If necessary to increase conspicuity, mark both edges of the paved portion of the taxiway with two continuous 6-inch (15 cm) wide yellow lines spaced 6 inches (15 cm) apart. Figure 4-12 illustrates taxiway centerline and edge markings.

**(2) Unpaved taxiway markings.** Use either raised or in-ground flush edge markers to provide strong visual cues to pilots. Space them longitudinally at approximately 15-foot (5 m) intervals on straight segments and at approximately 10-foot (3 m) intervals on curved segments. Figure 4-13 and Figure 4-14 illustrate taxiway edge markings.

**(a)** Raised-edge markers are blue, 4 inches (10 cm) in diameter, and 10 inches (25 cm) high, as illustrated in Figure 4-13.

**(b)** In-ground, flush edge markers are yellow, 12 inches (30 cm) wide, and approximately 5 feet (1.5 m) long.

**(3) Raised edge markers in grassy areas.** Raised edge markers are sometimes obscured by tall grass. Address this issue with 12-inch (30 cm) diameter concrete pads or solid material disks around the poles supporting the raised markers.

**(4) Taxiway to parking position transition requirements.** For paved taxiways and parking areas, taxiway centerline markings continue into parking positions and become the parking position centerlines.

**g. Parking position markings.** If a hospital heliport has a parking position, the following standards apply.

**(1) Paved parking position identifications.** Mark parking position identifications (numbers or letters) if there is more than one parking position. These markings are yellow characters 36 inches (91 cm) high. See Figure 4-20 and Figure C-1.

**(2) Rotor diameter circle.** Define the circle of the RD of the largest helicopter that will park at that position with a 6-inch (15 cm) wide, solid yellow line with an outside diameter of RD. In paved areas, this is a painted line (See Figure 4-20). In unpaved areas, use a series of flush markers, 6 inches (15 cm) in width, a maximum of 5 feet (1.5 m) in length, and with end-to-end spacing of approximately 5 feet (1.5 m).

**h. Touchdown/positioning circle (TDPC) marking.** An optional TDPC marking provides guidance to allow a pilot to touch down in a specific position on paved surfaces. When the pilot's seat is over the marking, the undercarriage will be inside the LBA, and all parts of the helicopter will be clear of any obstacle by a safe margin. A TDPC marking is a yellow circle with an inner diameter of  $\frac{1}{2} D$  and a line width of 18 in (46 cm). Locate a TDPC marking in the center of a parking area. Use a TDPC marking for "turn-around" parking areas. See Figure 4-20 and Figure 4-18.

**i. Maximum length marking.** On paved surfaces, indicate the D of the largest helicopter that the position is designed to accommodate (for example, 40) with this marking. This marking consists of yellow characters at least 36 inches (91 cm) high. See Figure 4-20 and Figure C-1.

**j. Parking position weight limit.** If a paved parking position has a weight limitation, mark it in units of 1,000 lbs as illustrated in Figure 4-20. (A 4 indicates a weight-carrying capability of up to 4,000 lbs. Do not use metric equivalents for this purpose.) This marking consists of yellow characters 36 inches (91 cm) high. Place a bar under the number if necessary to minimize the possibility of being misread. See Figure 4-18 and Figure C-1.

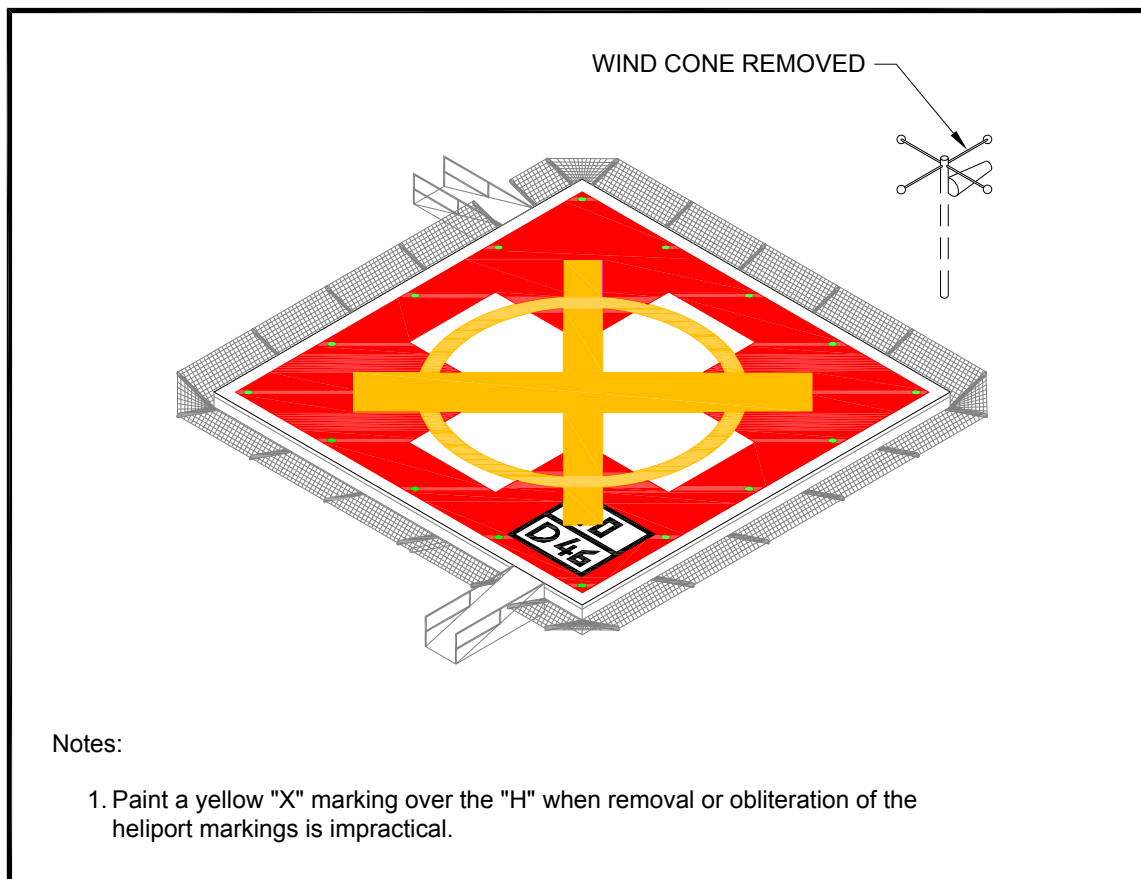
**k. Shoulder line markings.** Use optional shoulder line markings for paved parking areas (See Figure 4-15) to ensure safe rotor clearance. Locate a 6-inch (15 cm) wide solid yellow shoulder line,

perpendicular to the centerline and extending to the RD marking, so it is under the pilot's shoulder such that the main rotor of the largest helicopter for which the position is designed will be entirely within the rotor diameter parking circle (See Figure 4–20.) Use 0.25 D from the center of parking area to define the location of shoulder line. Use a shoulder line marking for “taxi through” and “back-out” parking areas.

**l. Walkways.** Figure 4–20 illustrates one marking scheme.

**m. Closed heliport.** Obliterate all markings of a permanently closed heliport, FATO, or TLOF. If it is impractical to obliterate markings, place a yellow “X” over the “H”, as illustrated in Figure 4–27. Use a yellow “X” large enough to ensure early pilot recognition that the heliport is closed. Remove the wind cone(s) and other visual indications of an active heliport.

**n. Marking sizes.** See Appendix C for guidance on the proportions of painted numbers.



**Figure 4–27. Marking a Closed Heliport: Hospital**

**415. Heliport lighting.** If the heliport operator intends for the facility to support night operations, light the heliport with FATO and/or TLOF perimeter lights as described below. Design flush light fixtures and installation methods to support point loads of the design helicopter transmitted through a skid or wheel.

**a. TLOF perimeter lights.**

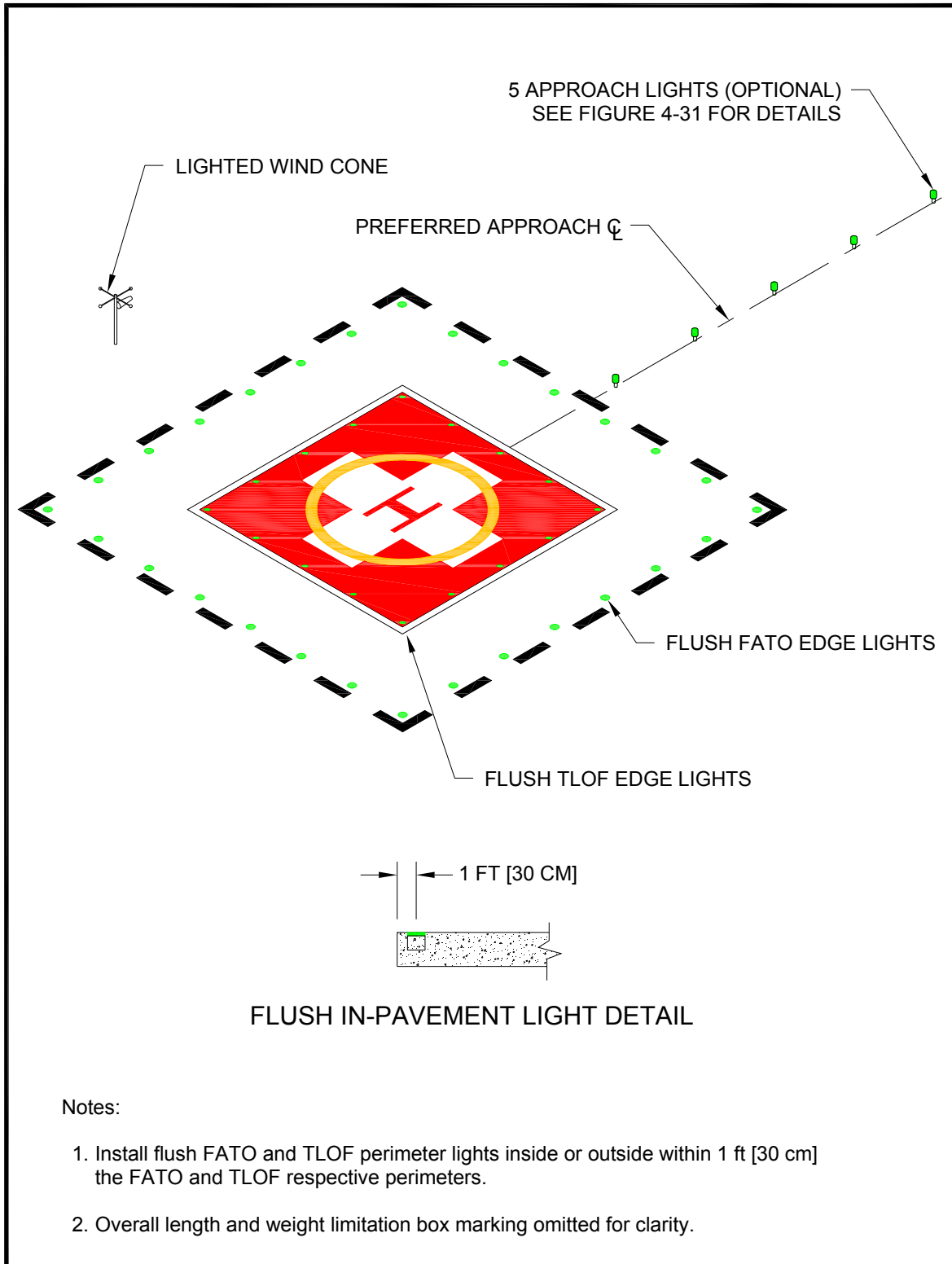
**(1) Ground level TLOF.** Use green lights meeting the requirements of FAA Airports Engineering Brief 87, Heliport Perimeter Light for Visual Meteorological Conditions (VMC), to define the TLOF perimeter. If only the TLOF is load bearing, use flush lights or, as a less desirable option, raised green omnidirectional lights. Use a minimum of three light fixtures per side of a square or rectangular TLOF. Locate a light at each corner, with additional lights uniformly spaced between the

corner lights. Using an odd number of lights on each side will place lights along the centerline of the approach. To define a circular TLOF, use an even number of lights, with a minimum of eight, uniformly spaced. Space the lights at a maximum of 25 feet (7.6 m). Locate flush lights within 1 foot (30 cm) (inside or outside) of the TLOF perimeter. Locate raised lights outside and within 10 feet (3 m) of the edge of the TLOF. Make sure raised lights do not penetrate a horizontal plane at the TLOF elevation by more than 2 inches (5 cm). Figure 4–28 and Figure 4–30 illustrate these lights.

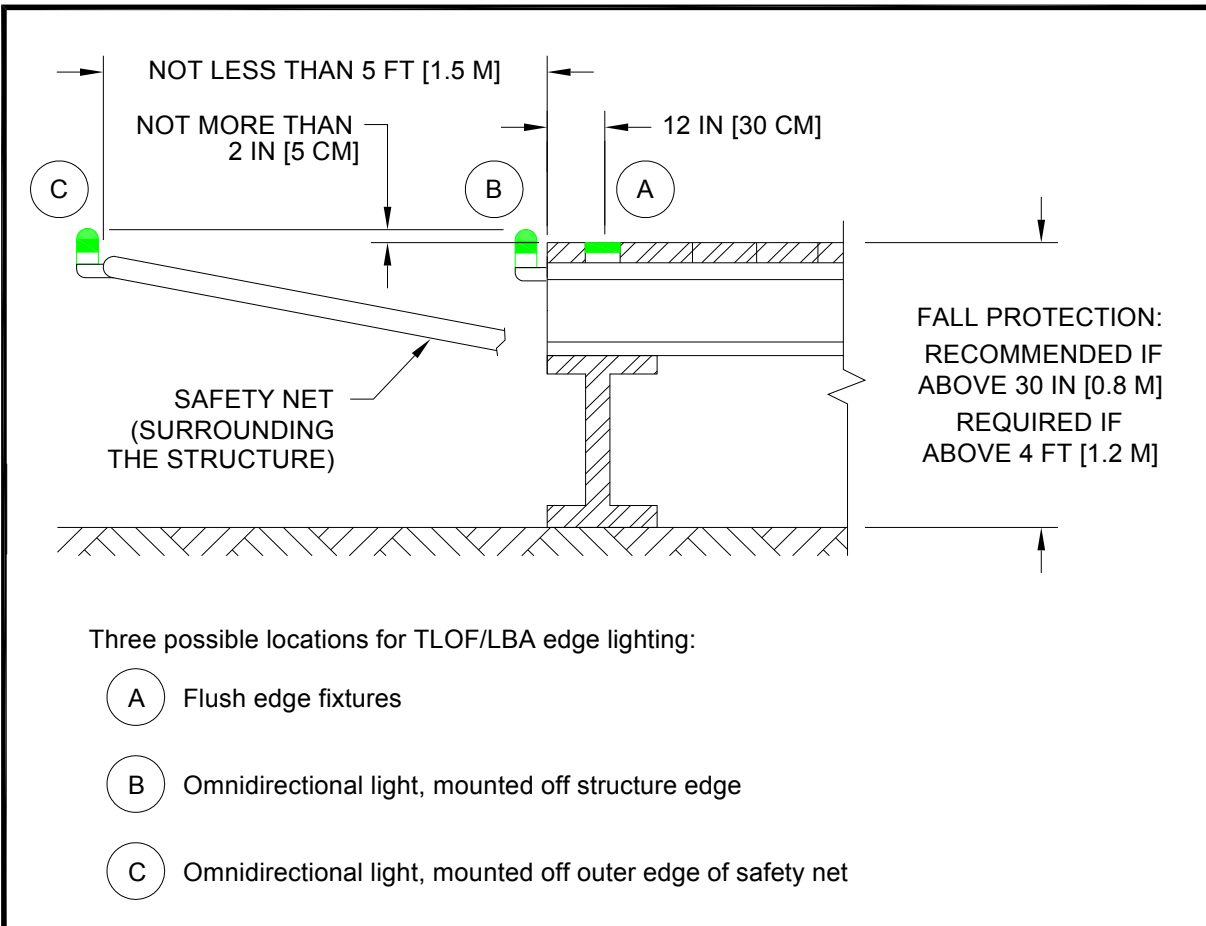
**(2) Elevated TLOF.** As an option, use raised, omnidirectional lights meeting the requirements of EB 87, located on the outside edge of the TLOF or the outer of the safety net, as shown in Figure 4–29. Lighting on the outer edge of the safety net provides better visual cues to pilots at a distance from the heliport since it outlines a larger area. Make sure raised lights do not penetrate a horizontal plane at the TLOF elevation by more than 2 inches (5 cm).

**b. Load-bearing FATO perimeter lights.** Use green lights meeting the requirements of EB 87 to define the perimeter of a load bearing FATO. Do not light the FATO perimeter if any portion of the FATO is not a load-bearing surface. Use a minimum of three flush or raised light fixtures per side of a square or rectangular FATO. Locate a light is located at each corner, with additional lights uniformly spaced between the corner lights. Using an odd number of lights on each side will place lights along the centerline of the approach. To define a circular FATO, use an even number of lights, with a minimum of eight, uniformly spaced. Space lights at a maximum of 25 feet (7.6 m). Locate flush lights within 1 foot (30 cm) (inside or outside) of the FATO perimeter (see Figure 4–28 and Figure 4–30). As an option, use a rectangular light pattern even if the TLOF is circular. At a distance during nighttime operations, a square or rectangular pattern of FATO perimeter lights provides the pilot with better visual alignment cues than a circular pattern, but a circular pattern may be more effective in an urban environment. In the case of an elevated FATO with a safety net, mount the perimeter lights in a similar manner as discussed in paragraph 415. Make sure raised FATO perimeter lights are no more than 8 inches (20 cm) high, and locate them 10 feet (3 m) from the FATO perimeter.

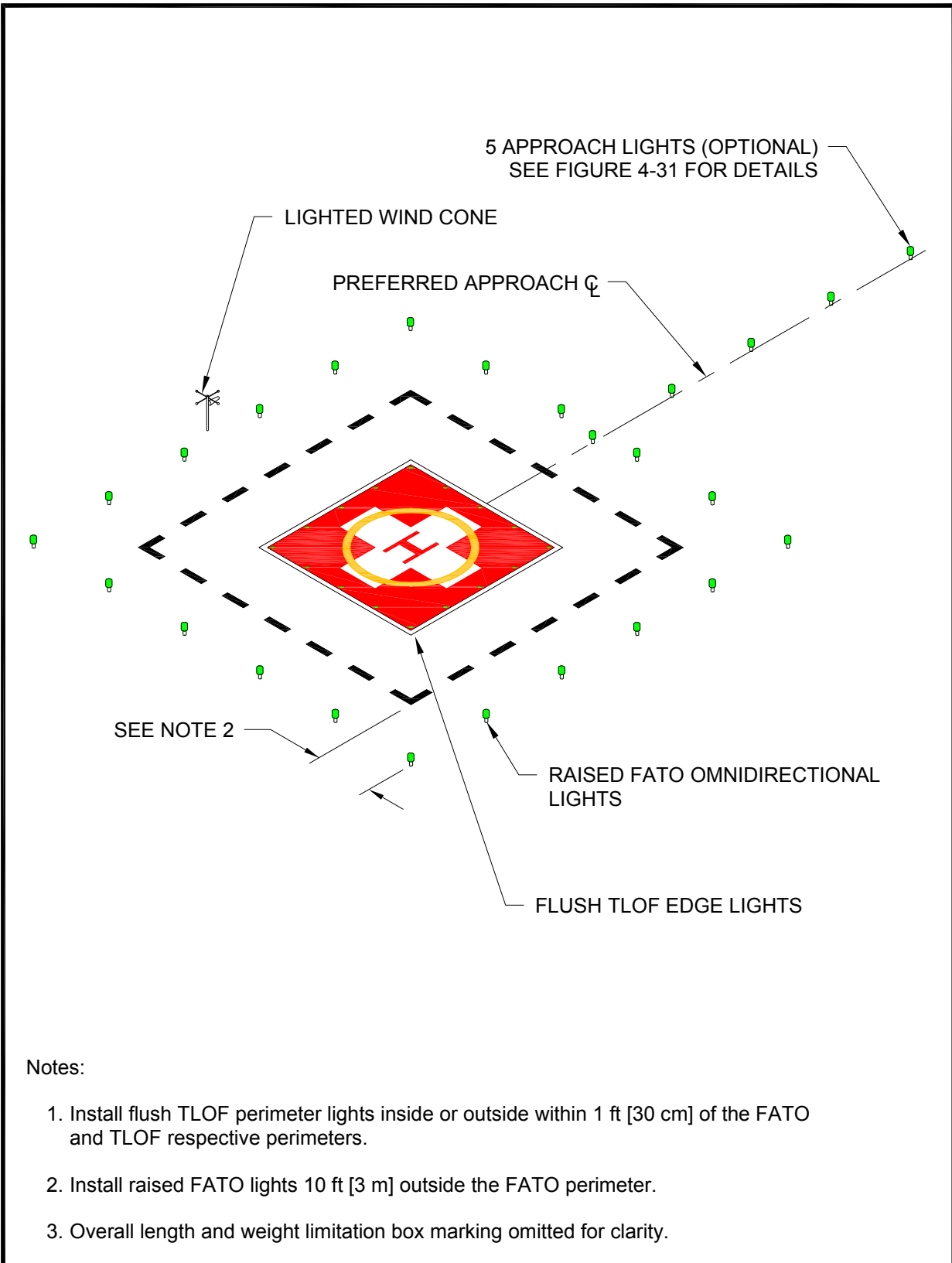
**c. Floodlights.** The FAA has not evaluated floodlights for effectiveness in visual acquisition of a heliport. However, if ambient light does not adequately illuminate markings for night operations, use floodlights to illuminate the TLOF, the FATO, and/or the parking area. If possible, mount these floodlights on adjacent buildings to eliminate the need for tall poles. Take care, however, to place floodlights clear of the TLOF, the FATO, the safety area, and the approach/departure surfaces, and transitional surfaces. Ensure floodlights and their associated hardware do not constitute an obstruction hazard. Aim floodlights down to provide adequate illumination on the surface. Make sure floodlights that might interfere with pilot vision during takeoff and landings are capable of being turned off by pilot control or at pilot request.



**Figure 4–28. Flush TLOF/FATO Perimeter Lighting: Hospital**



**Figure 4–29. Elevated TLOF, Safety Net and Lighting Heliport Partial Elevation: Hospital**



**Figure 4-30. Flush TLOF and Raised FATO Perimeter Lighting: Hospital**

**d. Landing direction lights.** As an option when it is necessary to provide directional guidance, install landing direction lights. Landing direction lights are a configuration of five green omnidirectional lights meeting the standards of EB 87, on the centerline of the preferred approach/departure path. Space these lights at 15-foot (5 m) intervals beginning at a point not less than 20 feet (6 m) and not more than 60 feet (18 m) from the TLOF perimeter and extending outward in the direction of the preferred approach/departure path, as illustrated in Figure 4–31.

**e. Flight path alignment lights.** Flight path alignment lights meeting the requirements of EB 87 are optional. Place them in a straight line along the direction of approach and/or departure flight paths. If necessary, extend them across the TLOF, FATO, safety area or any suitable surface in the immediate vicinity of the FATO or safety area. Install three or more green lights spaced at 5 feet (1.5 m) to 10 feet (3.0 m). See Figure 4–10.

**f. Taxiway and taxi route lighting.**

**(1) Taxiway centerline lights.** Define taxiway centerlines with flush bidirectional green lights meeting the standards of AC 150/5345-46, Specification for Runway and Taxiway Light Fixtures, for type L-852A (straight segments) or L-852B (curved segments). Space these lights at maximum 50-foot (15 m) longitudinal intervals on straight segments and at maximum 25 foot (7.6 m) intervals on curved segments, with a minimum of four lights needed to define the curve. Uniformly offset taxiway centerline lights no more than two feet (0.6 m) if necessary to ease painting the taxiway centerline. As an option, use green retroreflective markers meeting requirements for Type I markers in AC 150/5345-39, Specification for L-853, Runway and Taxiway Retroreflective Markers in lieu of the L-852A or L-852B lighting fixtures.

**(2) Taxiway edge lights.** Use omnidirectional blue lights to light the edges of a taxiway. As an option, use blue retroreflective markers to identify the edges of the taxiway in lieu of lights. Make sure retroreflective markers are no more than 8 inches (20 cm) tall.

**(a) Straight segments.** Space lights at 50 feet (15.2 m) longitudinal intervals on straight segments.

**(b) Curved segments.** Curved taxiway edges require shorter spacing of edge lights. Determine the spacing based on the radius of the curve. The applicable spacing for curves is shown in AC 150/5340-30, Design and Installation Detail for Airport Visual Aids. Space the taxiway edge lights uniformly. Use at least three edge lights for curved edges of more than 30 degrees from point of tangency (PT) of the taxiway section to PT of the intersecting surface. For radii not listed in AC 150/5340-30, determine spacing by linear interpolation.

**(c) Paved taxiways.** Use flush lights meeting the standards of AC 150/5345-46 for type L-852T.

**(d) Unpaved taxiways.** Use raised lights meeting the standards of AC 150/5345-46 for type L-861T. Use a maximum lateral spacing for the lights or reflectors equal to the RD of the design helicopter, but not more than 35 feet (10.7 m).



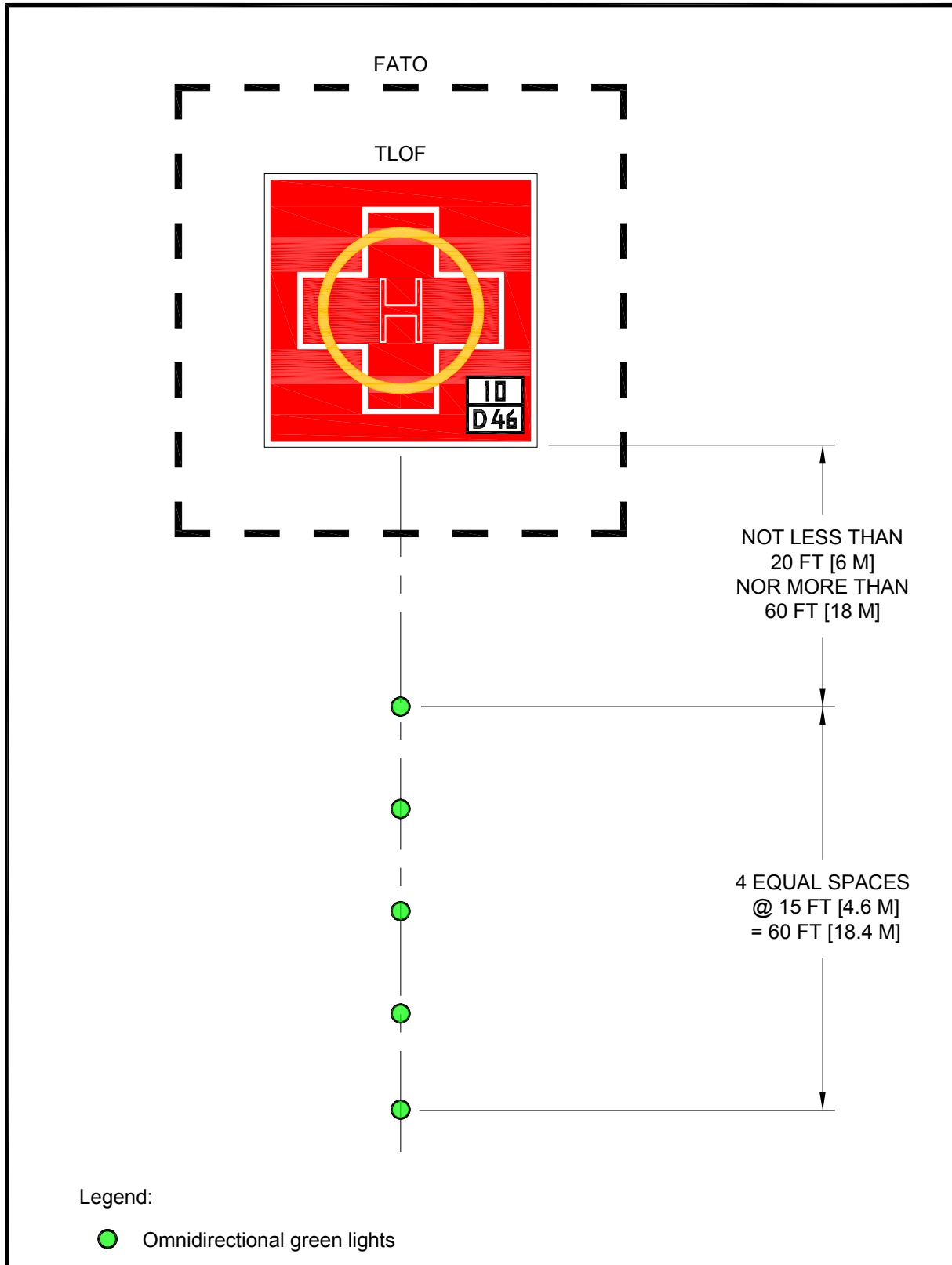


Figure 4-31. Landing Direction Lights: Hospital

**g. Heliport identification beacon.** A heliport identification beacon is optional equipment. It is the most effective means to aid the pilot in visually locating the heliport. Locate the beacon, flashing white/green/yellow at the rate of 30 to 45 flashes per minute, on or close to the heliport. Find guidance on heliport beacons in AC 150/5345-12, Specification for Airport and Heliport Beacon. As an option, allow the beacon to be pilot controllable, so it is “on” only when needed.

**416. Marking and lighting of difficult-to-see objects.** It is often difficult for pilot to see unmarked wires, antennas, poles, cell towers, and similar objects, even in the best daylight weather, in time to take evasive action. While pilots can avoid such objects during en route operations by flying well above them, approaches and departures require operations near the ground where obstacles may be a factor. This paragraph discusses the marking and lighting of objects near, but outside and below the approach/departure surface. Find guidance on marking and lighting objects in AC 70/7460-1, Obstruction Marking and Lighting.

**a. Airspace.** If difficult-to-see objects penetrate the object identification surfaces illustrated in Figure 4–32 and Figure 4–33, mark these objects to make them more conspicuous. If a heliport supports operations between dusk and dawn, light these difficult-to-see objects. Guidance on marking and lighting objects is contained in AC 70/7460-1. The object identification surfaces in Figure 4–32 and Figure 4–33 can also be described as follows:

**(1)** In all directions from the safety area, except under the approach/departure paths, the object identification surface starts at the safety area perimeter and extends out horizontally for a distance of 100 feet (30.5 m).

**(2)** Under the approach/departure surface, the object identification surface starts from the outside edge of the FATO and extends horizontally out along the approach path for a distance of 800 feet (244 m). From this point, the object identification surface extends out along the approach path for an additional distance of 3,200 feet (975 m) while rising on an 8:1 slope (8 units horizontal in 1 unit vertical). From the point 800 feet (244 m) from the FATO perimeter, the object identification surface is 100 feet (30.5 m) beneath the approach/departure surface.

**(3)** The width of the safety surface increases as a function of distance from the safety area. From the safety area perimeter, the object identification surface extends laterally to a point 100 feet (30.5 m) outside the safety area perimeter. At the upper end of the surface, the object identification surface extends laterally 200 feet (61 m) on either side of the approach/departure path.

**b. Shielding of objects.** Title 14 CFR part 77.9, Construction or alteration requiring notice, provides that if there are a number of objects close together, it may not be necessary to mark all of them if they are shielded. To meet the shielding guidelines part 77 requires that an object “be shielded by existing structures of a permanent and substantial nature or by natural terrain or topographic features of equal or greater height, and will be located in the congested area of a city, town, or settlement where the shielded structure will not adversely affect safety in air navigation.”

**c. Equipment/object marking.** Make heliport maintenance and servicing equipment, as well as other objects used in the airside operational areas, conspicuous with paint, reflective paint, reflective tape, or other reflective markings. Find additional guidance in AC 150/5210-5, Painting, Marking, and Lighting of Vehicles Used on an Airport.

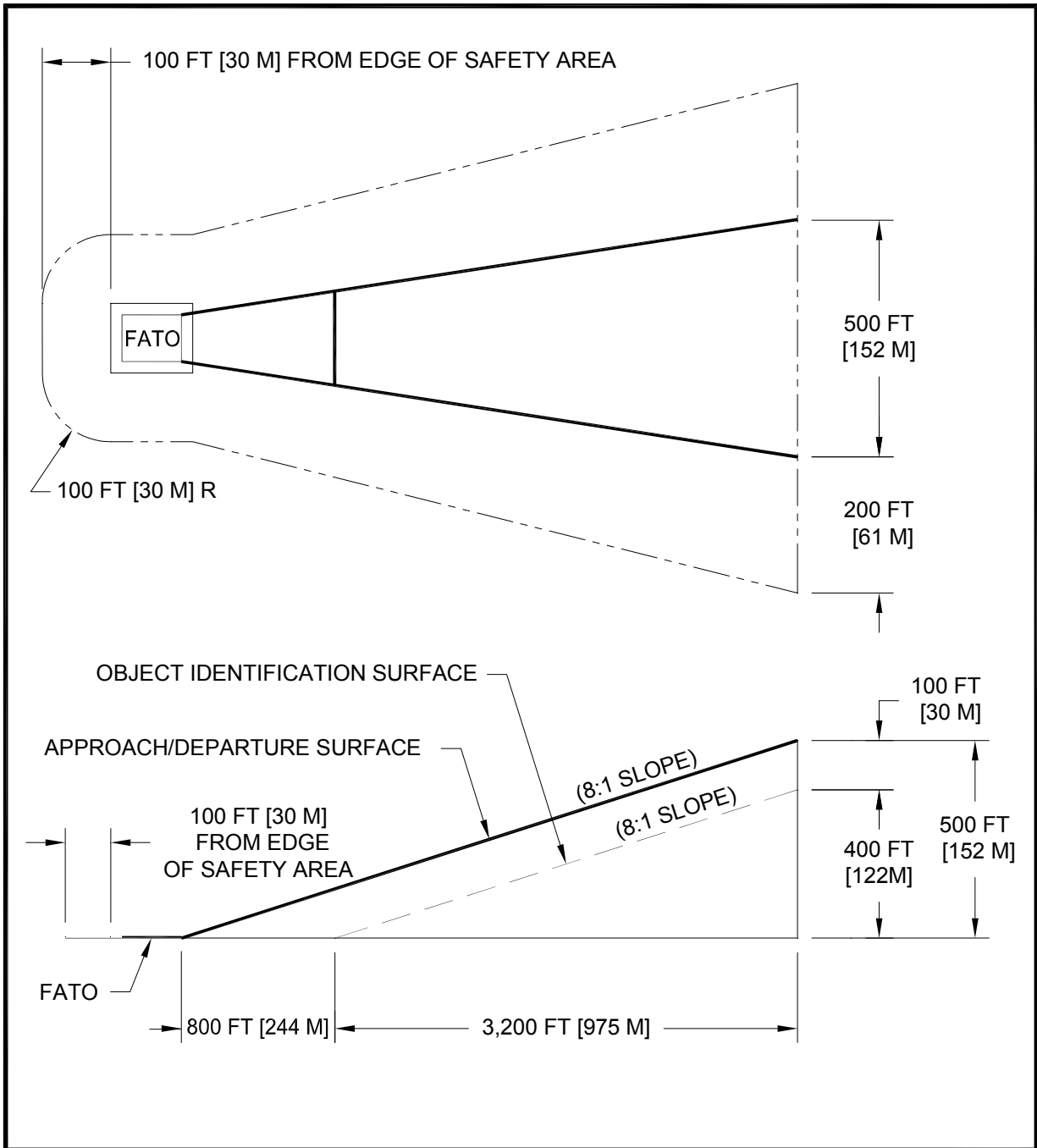
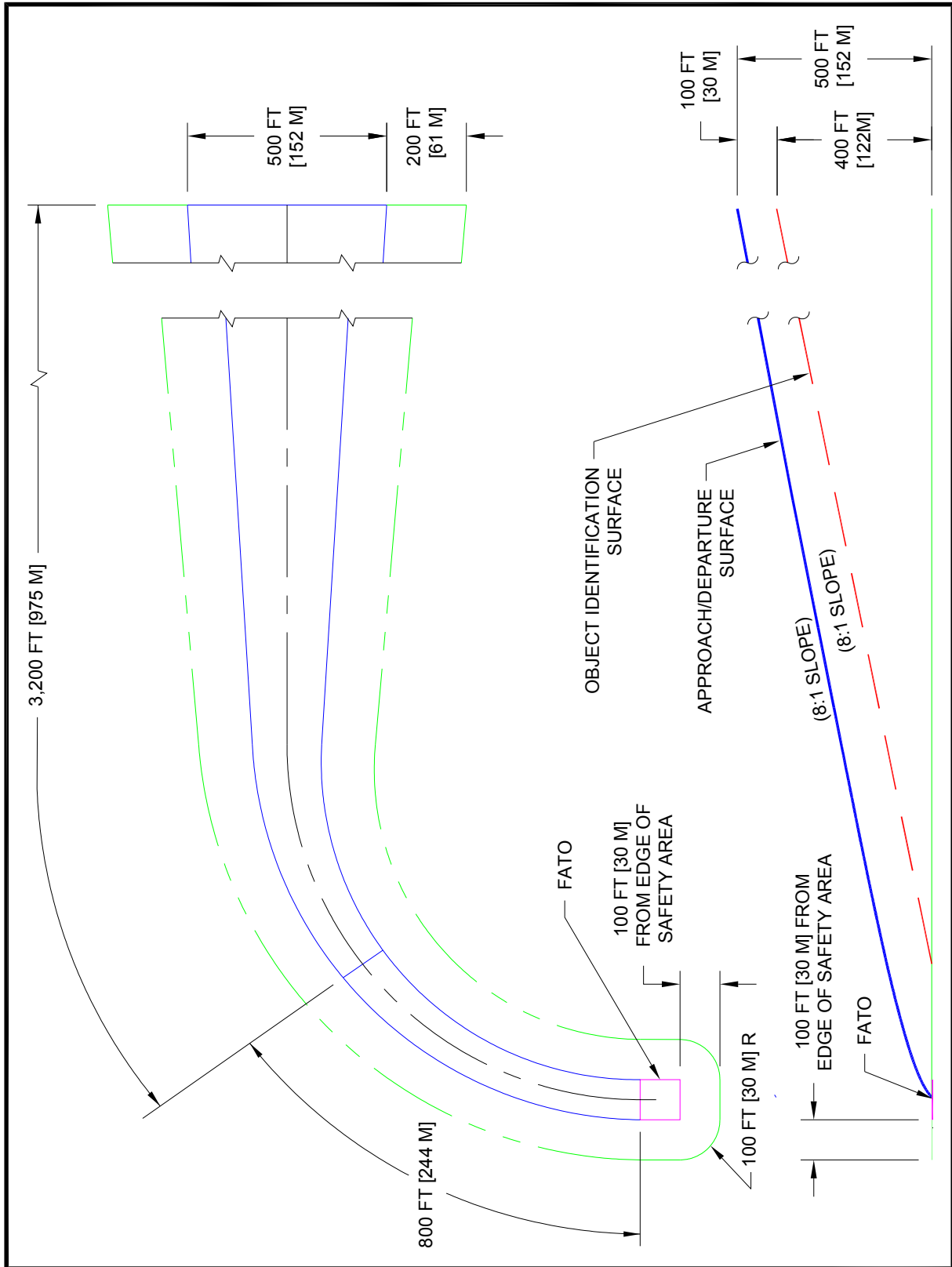


Figure 4-32. Airspace Where Marking and Lighting are Recommended: Hospital



**Figure 4-33. Airspace Where Marking and Lighting are Recommended:  
Curved Approach: Hospital**

**417. Safety considerations.** Consider the safety enhancements discussed below in the design of a heliport. Address other areas such as the effects of rotor downwash based on site conditions and the design helicopter.

**a. Security.** Provide a means to keep the operational areas of a hospital heliport clear of people, animals, and vehicles. Use a method to control access depending upon the helicopter location and types of potential intruders.

**(1) Safety barrier.** At ground-level hospital heliports, erect a safety barrier around the helicopter operational areas in the form of a fence or a wall. Construct the barrier no closer to the operation areas than the outer perimeter of the safety area. Make sure the barrier does not penetrate any approach/departure (primary or transitional) surface. If necessary in the vicinity of the approach/departure paths, install the barrier well outside the outer perimeter of the safety area.

**(2)** Make sure any barrier is high enough to present a positive deterrent to persons inadvertently entering an operational area and yet low enough to be non-hazardous to helicopter operations.

**(3) Access.** Control access to airside areas in a manner commensurate with the barrier (for example, build fences with locked gates). Display a cautionary sign similar to that illustrated in Figure 4-34 on gates and doors. As an option at hospital heliport, secure operational areas via the use of security guards and a mixture of fixed and movable barriers.

**b. Rescue and fire-fighting services.** Heliports are subject to state and local rescue and fire-fighting regulations. Provide a fire hose cabinet or extinguisher at each access gate/door and each fueling location. Locate fire hose cabinets, fire extinguishers, and other fire-fighting equipment near, but below the level of, the TLOF. Find additional information in various NFPA publications. For more reference material, see Appendix D.

**c. Communications.** Use a Common Traffic Advisory Frequency (CTAF) radio to provide arriving helicopters with heliport and traffic advisory information but do not use this radio to control air traffic. Contact the Federal Communications Commission (FCC) for information on CTAF licensing.

**d. Weather information.** An automated weather observing system (AWOS) measures and automatically broadcasts current weather conditions at the heliport site. When installing an AWOS, locate it at least 100 feet (30 m) and not more than 700 feet (213 m) from the TLOF and such that its instruments will not be affected by rotor wash from helicopter operations. Find guidance on AWOS systems in AC 150/5220-16, Automated Weather Observing Systems (AWOS) for Non-Federal Applications, and FAA Order 6560.20, Siting Criteria for Automated Weather Observing Systems (AWOS). Other weather observing systems will have different siting criteria.

**e. Winter operations.** Swirling snow raised by a helicopter's rotor wash can cause the pilot to lose sight of the intended landing point and/or hide objects that need to be avoided. Design the heliport to accommodate the methods and equipment used for snow removal. Design the heliport to allow the snow to be removed sufficiently so it will not present an obstruction hazard to the tail rotor, main rotor, or undercarriage. Find guidance on winter operations in AC 150/5200-30, Airport Winter Safety and Operations.



Figure 4-34. Caution Sign: Hospital

**418. Visual glideslope indicators (VGSI).** A VGSI provides pilots with visual vertical course and descent cues. Install the VGSI such that the lowest on-course visual signal provides a minimum of 1 degree of clearance over any object that lies within 10 degrees of the approach course centerline.

**a. Siting.** The optimum location of a VGSI is on the extended centerline of the approach path at a distance that brings the helicopter to a hover with the undercarriage between 3 and 8 feet (0.9 to 2.5 m) above the TLOF. Figure 4–35 illustrates VGSI clearance criteria. To properly locate the VGSI, estimate the vertical distance from the undercarriage to the pilot’s eye.

**b. Control of the VGSI.** As an option, allow the VGSI to be pilot controllable such that it is “on” only when required.

**c. VGSI needed.** A VGSI is an optional feature. However, provide a VGSI if one or more of the following conditions exist, especially at night:

(1) Obstacle clearance, noise abatement, or traffic control procedures require a particular slope to be flown.

(2) The environment of the heliport provides few visual surface cues.

**d. Additional guidance.** AC 150/5345-52, Generic Visual Glideslope Indicators (GVGI), and AC 150/5345-28, Precision Approach Path Indicator (PAPI) Systems, provide additional guidance.

**419. Zoning and compatible land use.** Where state and local statutes permit, the FAA encourages a hospital heliport operator to promote the adoption of the following zoning measures to ensure the heliport will continue to be available and to protect the investment in the facility.

**a. Zoning to limit building/object heights.** Find general guidance on drafting an ordinance that would limit building and object heights in AC 150/5190-4, A Model Zoning Ordinance to Limit Height of Objects Around Airports. Substitute the heliport surfaces for the airport surfaces in the model ordinance.

**b. Zoning for compatible land use.** The FAA encourages public agencies to enact zoning ordinances to control the use of property within the HPZ and the approach/departure path environment, restricting activities to those compatible with helicopter operations.

**e. Air rights and property easements.** Use air rights and property easements as options to prevent the encroachment of obstacles in the vicinity of a heliport.

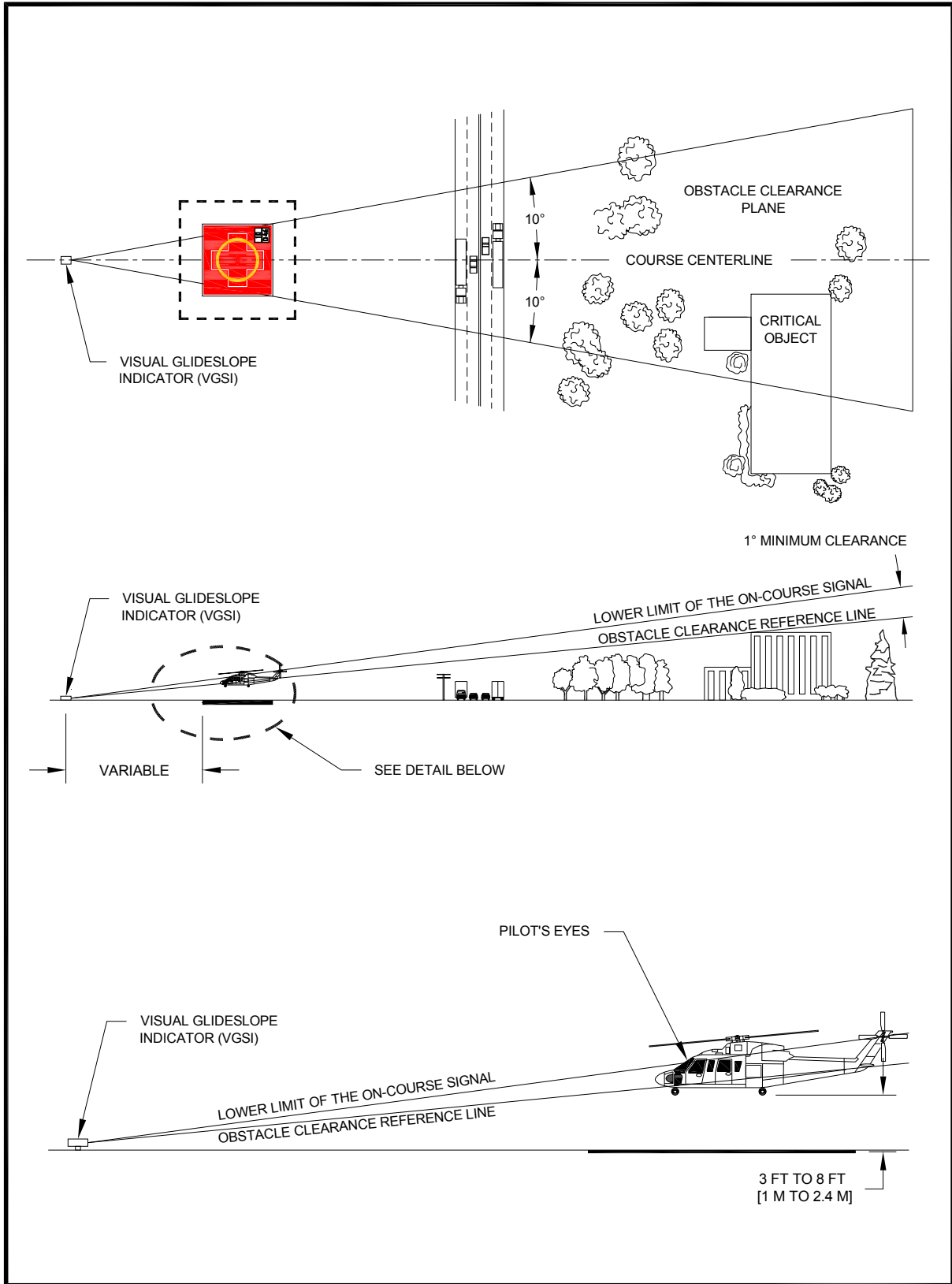


Figure 4-35. Visual Glideslope Indicator Siting and Clearance Criteria: Hospital



## Chapter 5. Helicopter Facilities on Airports

**501. General.** Helicopters are able to operate on most airports without unduly interfering with airplane traffic. If necessary, provide separate facilities and approach/departure procedures when the volume of airplane and/or helicopter traffic affects operations. At airports with interconnecting passenger traffic, provide gates at the terminal for helicopter boarding. People who use a helicopter to go to an airport generally require convenient access to the airport terminal and the services provided to airplane passengers. Identify the location of the exclusive-use helicopter facilities, TLOFs, FATOs, safety areas, approach/departure paths, and helicopter taxi routes and taxiways on the airport layout plan (ALP). This chapter addresses design considerations for providing separate helicopter facilities on airports. Figure 5-1 shows an example of a heliport located on an airport. Other potential heliport locations are on the roofs of passenger terminals or parking garages serving passenger terminals.

**502. Applicability.** The standards in this chapter apply to projects funded under the Airport Improvement Program (AIP) or Passenger Facility Charge (PFC) program. For other projects/heliports, these standards are the FAA's recommendations for designing all heliports on airports. The design standards in this chapter assume there will never be more than one helicopter within the final approach and takeoff area (FATO) and the associated safety area. If there is a need for more than one touchdown and lift-off area (TLOF) at a heliport, locate each TLOF within its own FATO and within its own safety area. Unless otherwise noted, the standards in Chapter 2 apply to helicopter facilities serving general aviation operations and the standards in Chapter 3 apply to helicopter facilities serving transport operations.

**503. Touchdown and liftoff area (TLOF).** Locate the TLOF to provide ready access to the airport terminal or to the helicopter user's origin or destination.

**504. Final approach and takeoff area (FATO).** Table 5-1 provides standards for the distance between the centerline of an approach to a runway and the centerline of an approach to a FATO for simultaneous, same direction, VFR operations.

**Table 5-1. Recommended Distance between FATO Center  
to Runway Centerline for VFR Operations**

Airplane Size	Small Helicopter 7,000 lbs or less	Medium Helicopter 7,001 to 12,500 lbs	Large Helicopter over 12,500 lbs
Small Airplane 12,500 lbs or less	300 feet (91 m)	500 feet (152 m)	700 feet (213 m)
Large Airplane 12,500 lbs to 300,000 lbs	500 feet (152 m)	500 feet (152 m)	700 feet (213 m)
Heavy Airplane Over 300,000 lbs	700 feet (213 m)	700 feet (213 m)	700 feet (213 m)

**505. Safety area.** Apply the safety area dimensions and clearances described in Chapter 2 to facilities being developed on an airport for general aviation helicopter use. Apply safety area dimensions and clearances in Chapter 3 to facilities being developed on an airport for transport helicopter use.

**506. VFR approach/departure paths.** To the extent practical, design helicopter approach/departure paths to be independent of approaches to and departures from active runways.

**507. Heliport protection zone (HPZ).** Establish an HPZ where it is practicable for the airport owner to acquire and plan the land uses within the HPZ. Where this is not practicable, the HPZ standards have recommendation status for that portion of the HPZ the airport owner does not control.

**508. Taxiways and taxi routes.** When developing exclusive helicopter taxiways or taxi routes at an airport, locate them to minimize interaction with airplane operations.

**509. Helicopter parking.** Locate helicopter parking positions as close to the intended destination or origination of the passengers as conditions and safety permit.

**510. Security.** Unless screening was carried out at the helicopter passengers' departure location, Transportation Security Administration regulations may require that a screening area and/or screening be provided before passengers enter the airport's secured areas. If necessary, establish multiple helicopter parking positions and/or locations in the terminal area to service helicopter passenger screening and/or cargo interconnecting needs. Find information about passenger at the Transportation Security Administration web site <http://www.tsa.gov/public/>.

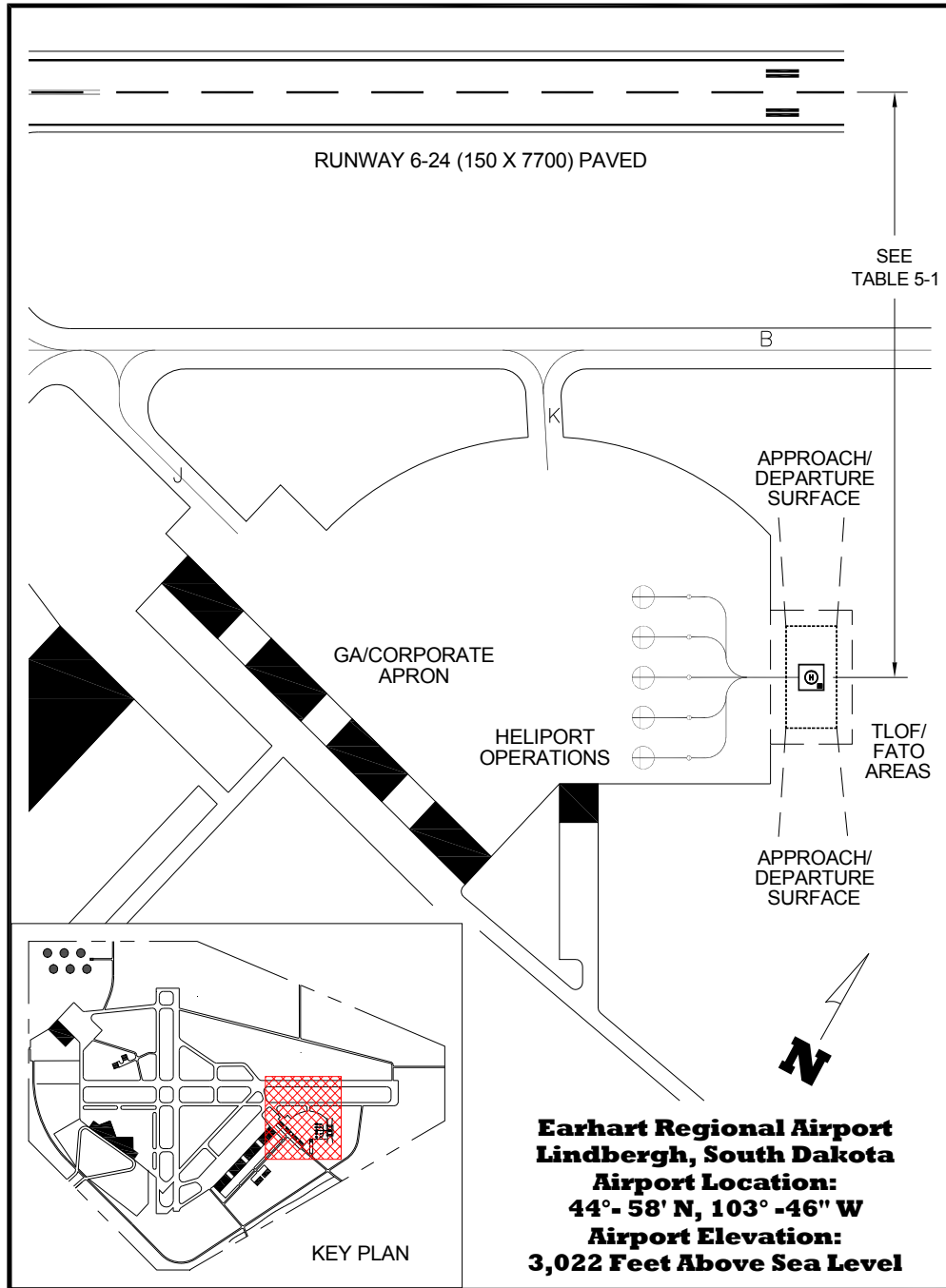


Figure 5-1. Heliport Located on an Airport: On Airport

**Intentionally Left Blank**

## Chapter 6. Instrument Operations

**601. General.** Instrument approach/departure/missed approach procedures permit helicopter operations to continue during periods of low cloud ceilings and reduced visibility. The FAA establishes Instrument approach procedures in accordance with FAA 8260 series Orders published by FAA Flight Procedures Standards Branch. When a heliport does not meet the criteria of this AC, or FAA 8260 Series Orders, the FAA publishes the helicopter instrument approach procedure as a SPECIAL procedure, with annotations that special aircrew qualifications, pilot training and aircraft equipment are required to fly the specific procedure(s).

**602. Planning.** This chapter addresses issues that heliport owners consider before requesting the development of instrument approach/departure/missed approach procedures. The standards and recommendations in this AC are not intended to be sufficient to design an instrument procedure. Initiate early contact with the appropriate FAA Flight Standards Office to establish instrument procedures.

**603. Airspace.** Those who design instrument approach/departure/missed approach procedures have some flexibility in the design of such procedures. For this and other reasons, the airspace required to support helicopter instrument approach/departure operations is complex, and it does not lend itself to simple descriptions, even using figures. Refer to the latest revision of FAA 8260-series orders for more detailed information on criteria for developing helicopter instrument approach/departure/missed approach procedures.

**604. Final approach reference area (FARA).** For precision instrument procedures only, a certificated helicopter precision approach procedure terminates with the helicopter coming to a hover or touching down within a 150-foot-wide (45 m) by at least 150-foot long (45 m) FARA. The FARA is located at the far end of a 300-foot-wide by 1,225-foot-long (91 m by 373 m) FATO required for a precision instrument procedure. For the purposes of requirements for LBA and lighting, substitute the FARA for the FATO. Figure 6-1 illustrates the FARA/FATO relationship.

**605. Improved lighting system.** Installing the lighting systems described below may result in lower visibility minimums. See Figure 6-2 and Figure 6-3.

**a. FATO perimeter lighting enhancement.** Insert an additional raised, green light meeting the standards of FAA Airports Engineering Brief 87, Heliport Perimeter Light for Visual Meteorological Conditions (VMC), between each light in the front and rear rows of the raised perimeter lights to enhance the definition of the FATO.

**b. Heliport instrument lighting system.** The HILS consists of 24 unidirectional PAR 56, 200-watt white lights that extend the FATO perimeter lights. The system extends both the right and left edge lights as “edge bars” and both the front and rear edge lights as “wing bars,” as shown in Figure 6-2.

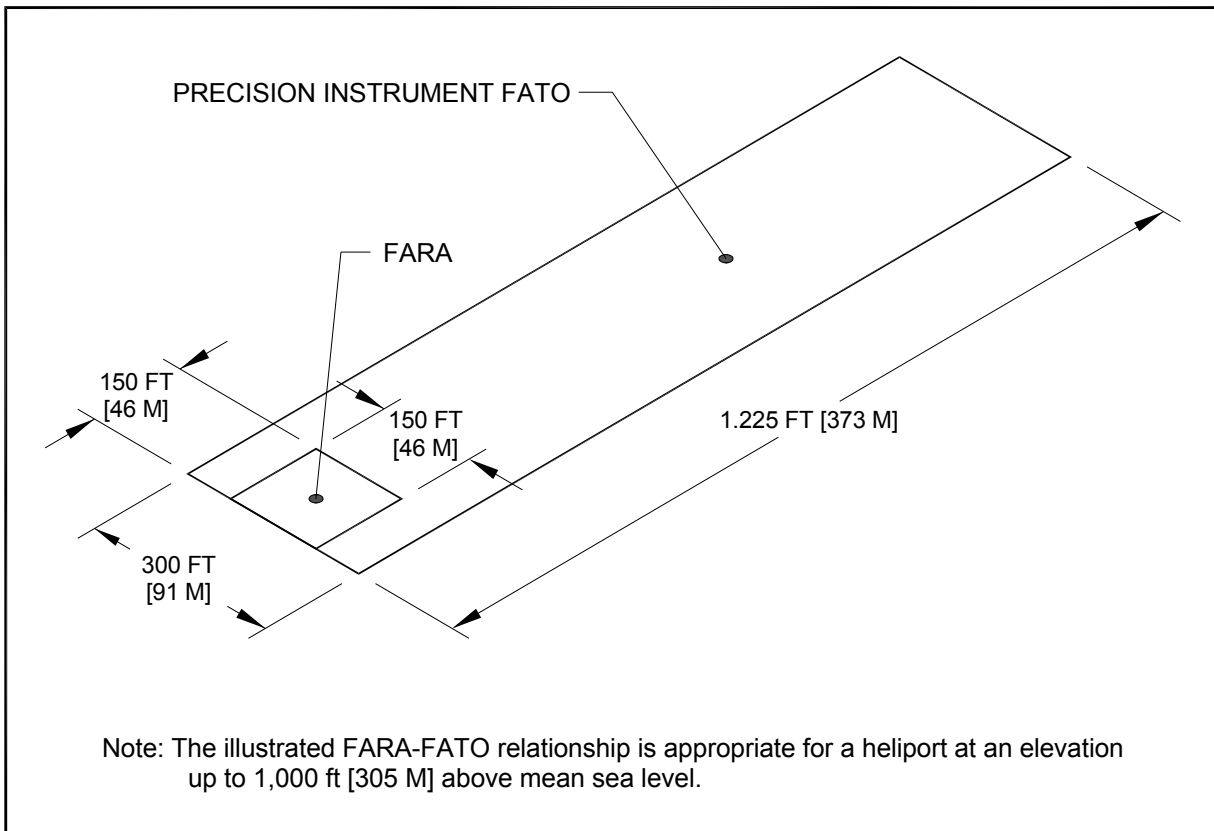
**(1) Edge bars.** Place edge bar lights at 50-foot (15.2 m) intervals, measured from the front and rear row of the FATO perimeter lights.

**(2) Wing bars.** Space wing bar lights at 15-foot (4.57 m) intervals, measured from the line of FATO perimeter (side) lights.

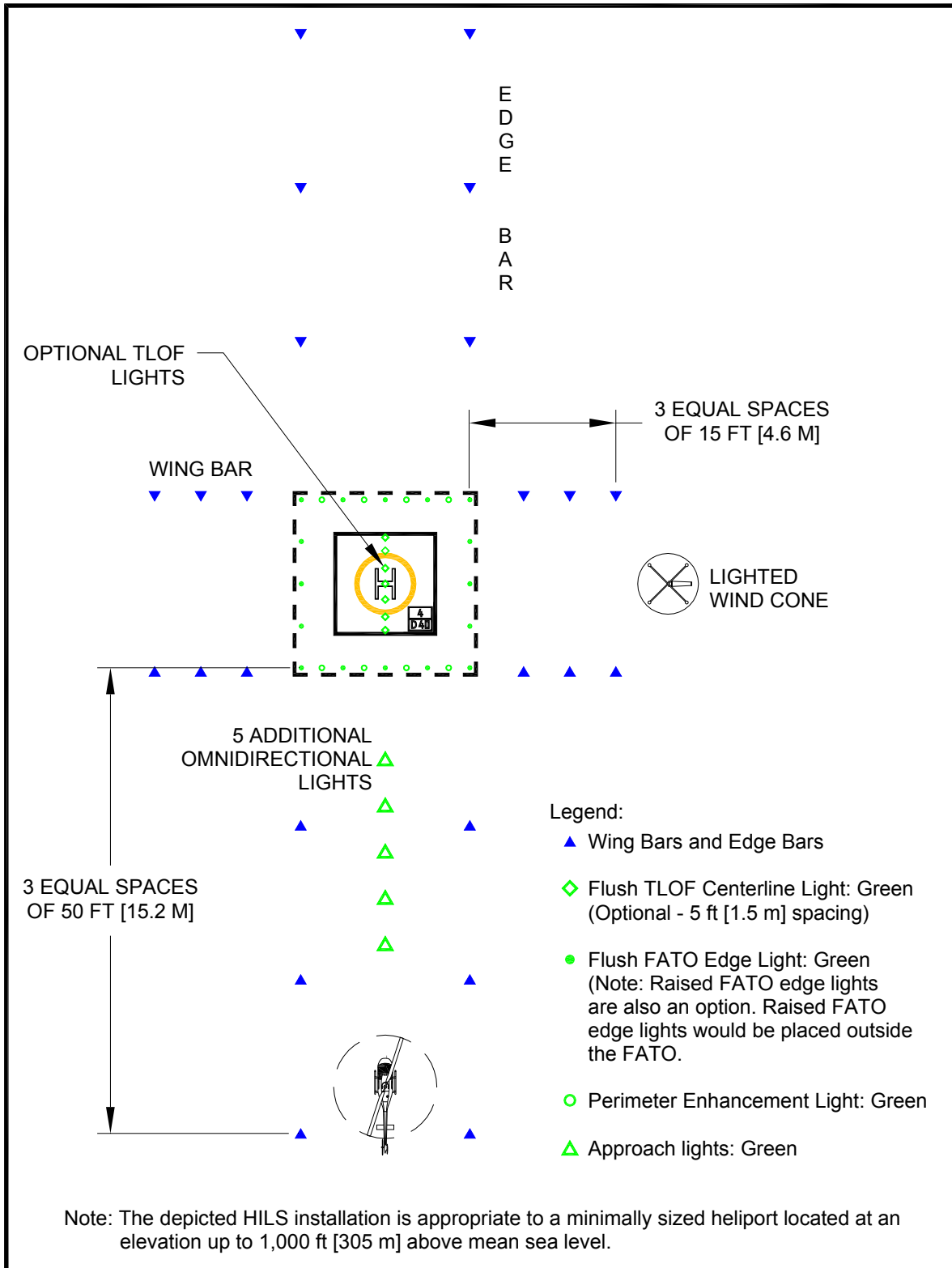
**(3) Optional TLOF lights.** A line of seven white flush lights meeting the standards of EB 87 is optional. Space them at 5-foot (1.5 m) intervals in the TLOF pavement. Align these lights on the centerline of the approach course to provide close-in directional guidance and improve TLOF surface definition. These lights are illustrated in Figure 6-2.

**c. Helicopter approach lighting System (HALS).** The HALS, depicted in Figure 6–3 is a distinctive approach lighting configuration designed to prevent it from being mistaken for an airport runway approach lighting system.

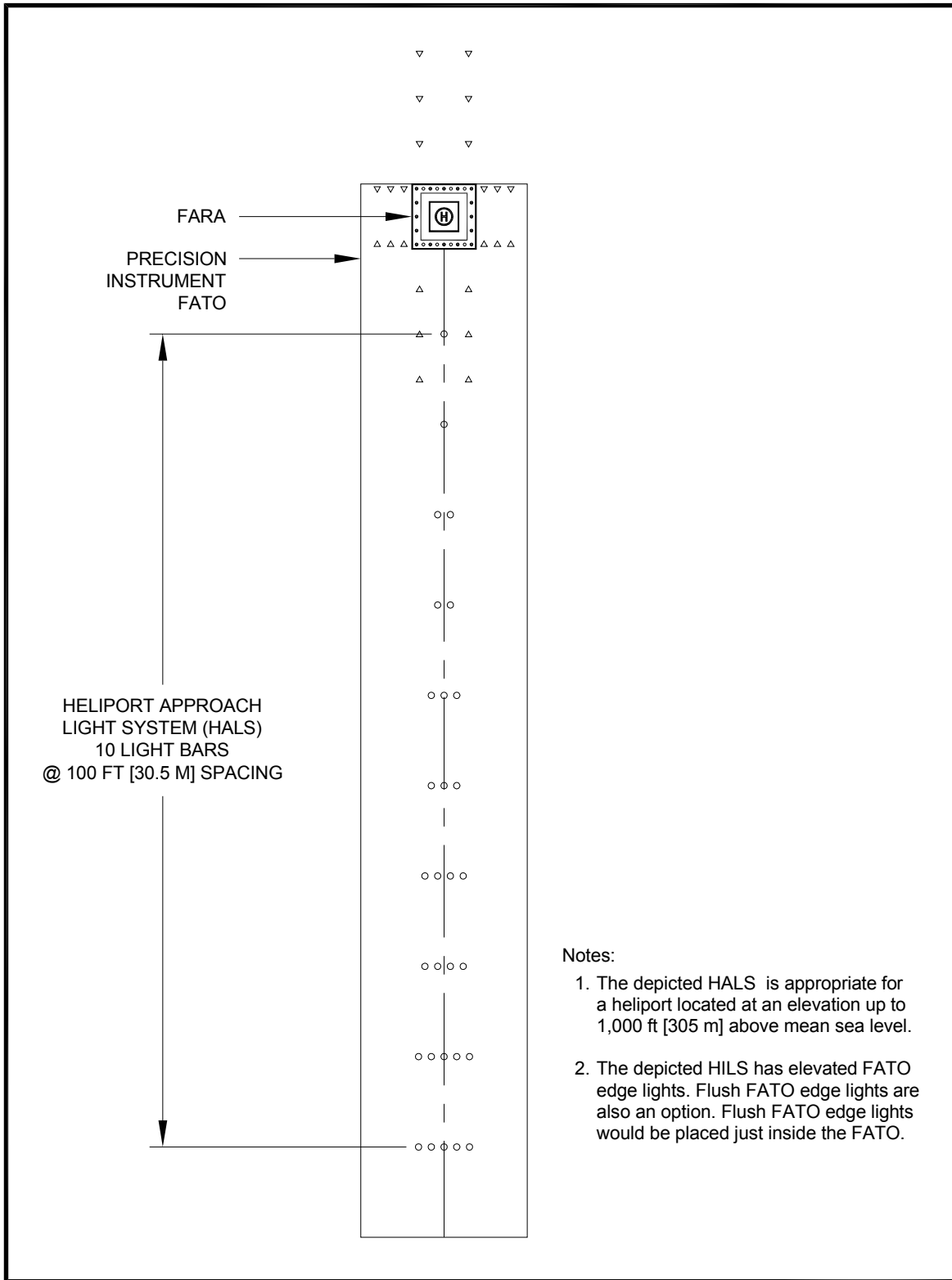
**606. Obstacle evaluation surfaces.** The instrument procedure developer considers the specific heliport location, its physical characteristics, the terrain, surrounding obstructions, and so on, in designing the helicopter instrument approach procedure. Upon development of the instrument procedure, protect its underlying obstacle evaluation surfaces from penetrations. See paragraph 221. Also see paragraphs 201.e, 301.e, and 401.e.



**Figure 6–1. FARA/FATO Relationship: Precision**



**Figure 6-2. Heliport Instrument Lighting System (HILS): Non-precision**



- Notes:
1. The depicted HALS is appropriate for a heliport located at an elevation up to 1,000 ft [305 m] above mean sea level.
  2. The depicted HILS has elevated FATO edge lights. Flush FATO edge lights are also an option. Flush FATO edge lights would be placed just inside the FATO.

Figure 6-3. Heliport Approach Lighting System



## Chapter 7. Heliport Gradients and Pavement Design

**701. General.** This chapter provides guidance on designing heliport pavements, including design loads, and addresses soil stabilization as a method of treating non paved operational surfaces. Provide a present a reasonably smooth, uniformly graded surface for operational surfaces such as the TLOF, FATO, safety areas, parking areas, taxi routes, and taxiways. Design the surfaces of a heliport to provide positive drainage.

### **702. TLOF gradients.**

**a. General aviation heliport.** To ensure drainage, design the TLOF to have a gradient between 0.5 percent and 2 percent.

**b. Transport heliport.** To ensure drainage, design the TLOF to have a longitudinal gradient between 0.5 and 1 percent and a transverse gradient between 0.5 and 1.5 percent.

**c. Hospital heliport.** To ensure drainage, design the TLOF to have a gradient between 0.5 and 1 percent and 2 percent.

### **703. FATO gradients.**

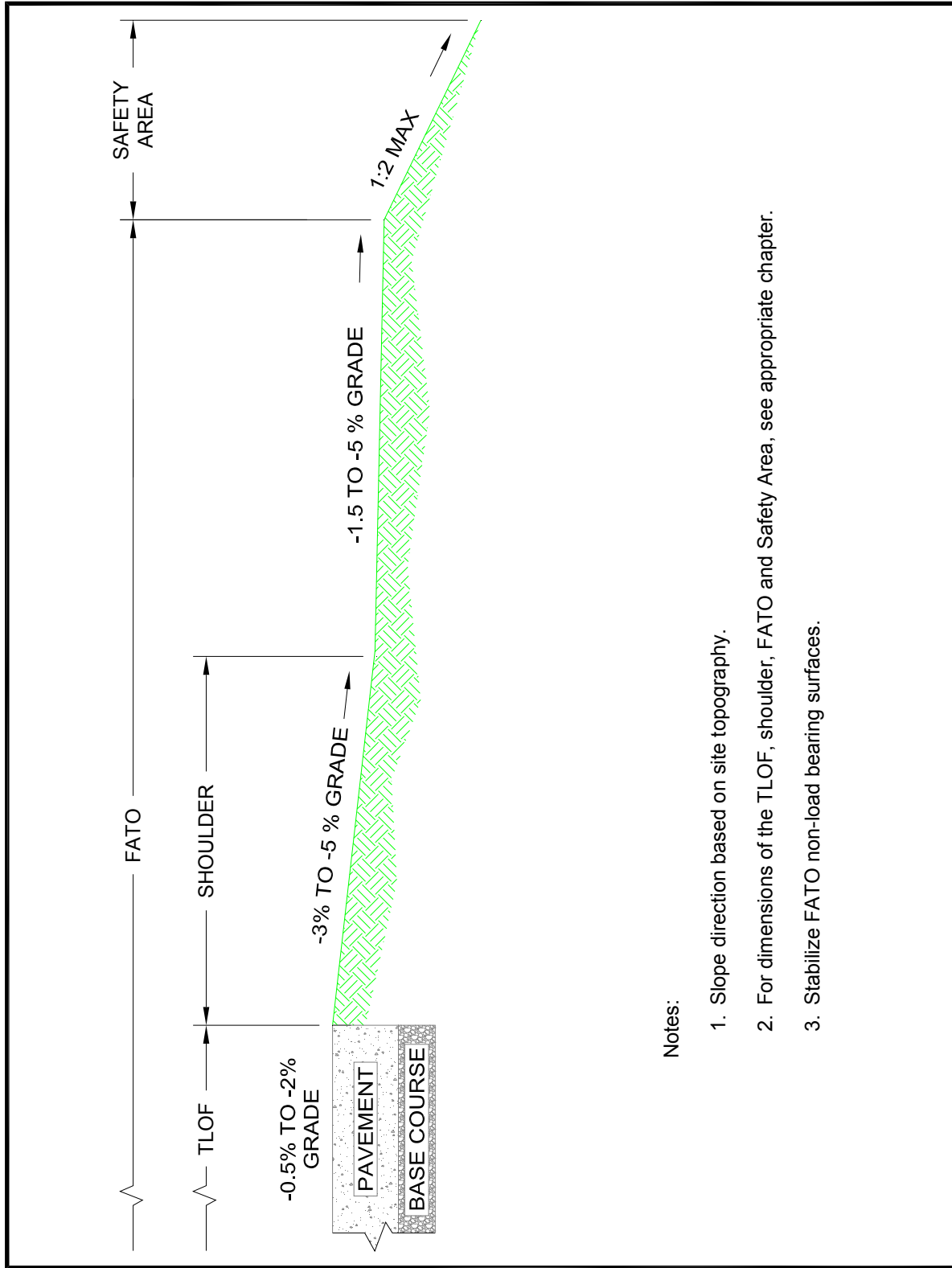
**a. Load bearing FATO.** Design a load bearing FATO to have a gradient between 0.5 percent and 5 percent. Design the gradient to be not more than 2 percent in any areas where a helicopter is expected to land. To ensure TLOF drainage, design gradients of rapid runoff shoulders to be between 3 and 5 percent. These standards are illustrated in Figure 7–1 below for a concrete TLOF and stabilized turf FATO.

**b. Non-load bearing FATO.** When the FATO is non-load bearing and/or not intended for use by the helicopter, there are no specific requirements for the gradient of the surface. In this case, design the gradient to be 5 percent or more to ensure adequate drainage away from the area of the TLOF. However, stabilize non-load bearing surfaces. See paragraph 707.

**704. Safety area gradients.** Design the surface of the safety area to be no steeper than a downward slope of 2:1 (2 units horizontal in 1 unit vertical). In addition, make sure the surface of the safety area is not higher than the FATO edge.

**705. Parking area gradients.** Design all helicopter parking area grades to not exceed 2 percent.

**706. Taxiway and taxi route gradients.** Design taxiway longitudinal gradients to not exceed 2 percent. Design transverse gradients to be between 0.5 percent and 2 percent.



**Figure 7-1. Heliport Grades and Rapid Runoff Shoulder: Gradients and Pavement**

**707. Design loads.** Design and construct the TLOF and any load-bearing surfaces to support the weight of the design helicopter and any ground support vehicles. Loads are applied through the contact area of the tires for wheel-equipped helicopters or the contact area of the skid for skid equipped helicopters. Find lists of Helicopter weights, landing gear configurations, and dimensional data in Appendix B.

**a. Static loads.** For design purposes, the design static load is equal to the helicopter's maximum takeoff weight applied through the total contact area of the wheels or skids. Contact manufacturers to obtain the contact area for the specific helicopters of interest.

**b. Dynamic loads.** A dynamic load of 0.2 second or less duration may occur during a hard landing. For design purposes, assume dynamic loads at 150 percent of the takeoff weight of the design helicopter. When specific loading data is not available, assume 75 percent of the weight of the design helicopter to be applied equally through the contact area of the rear two rear wheels (or the pair rear wheels of a dual-wheel configuration) of a wheel-equipped helicopter. For a skid equipped helicopter assume 75 percent of the weight of the design helicopter to be applied equally through the aft contact areas of the two skids of a skid-equipped helicopter. (See Figure 7-2.) Contact manufacturers to obtain the aft contact area for specific helicopters of interest.

**c. Rotor loads.** Rotor downwash loads are approximately equal to the weight of the helicopter distributed uniformly over the disk area of the rotor. Tests have established that rotor downwash loads are generally less than the loads specified in building codes for snow, rain, or wind loads typically used in structural design calculations.

**708. Pavement design and soil stabilization.** Pavements distribute helicopters' weight over a larger area of the subsurface as well as provide a water-impervious, skid-resistant wearing surface. Pave TLOFs, FATOs, taxiways, and parking aprons to improve their load carrying ability, minimize the erosive effects of rotor wash, and facilitate surface runoff. Stabilize unpaved portions of the FATO and taxi routes subjected to rotor wash. In some instances, loads imposed by ground support vehicles may exceed those of the largest helicopter expected to use the facility. Find guidance on pavement design and on stabilizing soils in AC 150/5320-6, Airport Pavement Design and Evaluation, and AC 150/5370-10, Standards for Specifying Construction of Airports. These ACs are available at the Airports web site (<http://www.faa.gov/airports>).

**a. Pavements.** In most instances, a 6-inch thick (15 cm) portland cement concrete (PCC) pavement is capable of supporting operations by helicopters weighing up to 20,000 pounds (9,070 kg). Use thicker pavements for heavier helicopters or where the quality of the subsurface soil is questionable. If feasible, use PCC pavement for all surfaces used by helicopters.

**b. Stabilizing soils.** Use appropriate methods of soil stabilization to meet different site requirements. Consider helicopter weight, ground support vehicle weight, operational frequency, soil analysis, and climatic conditions in selecting the method(s) and extent of surface stabilization.

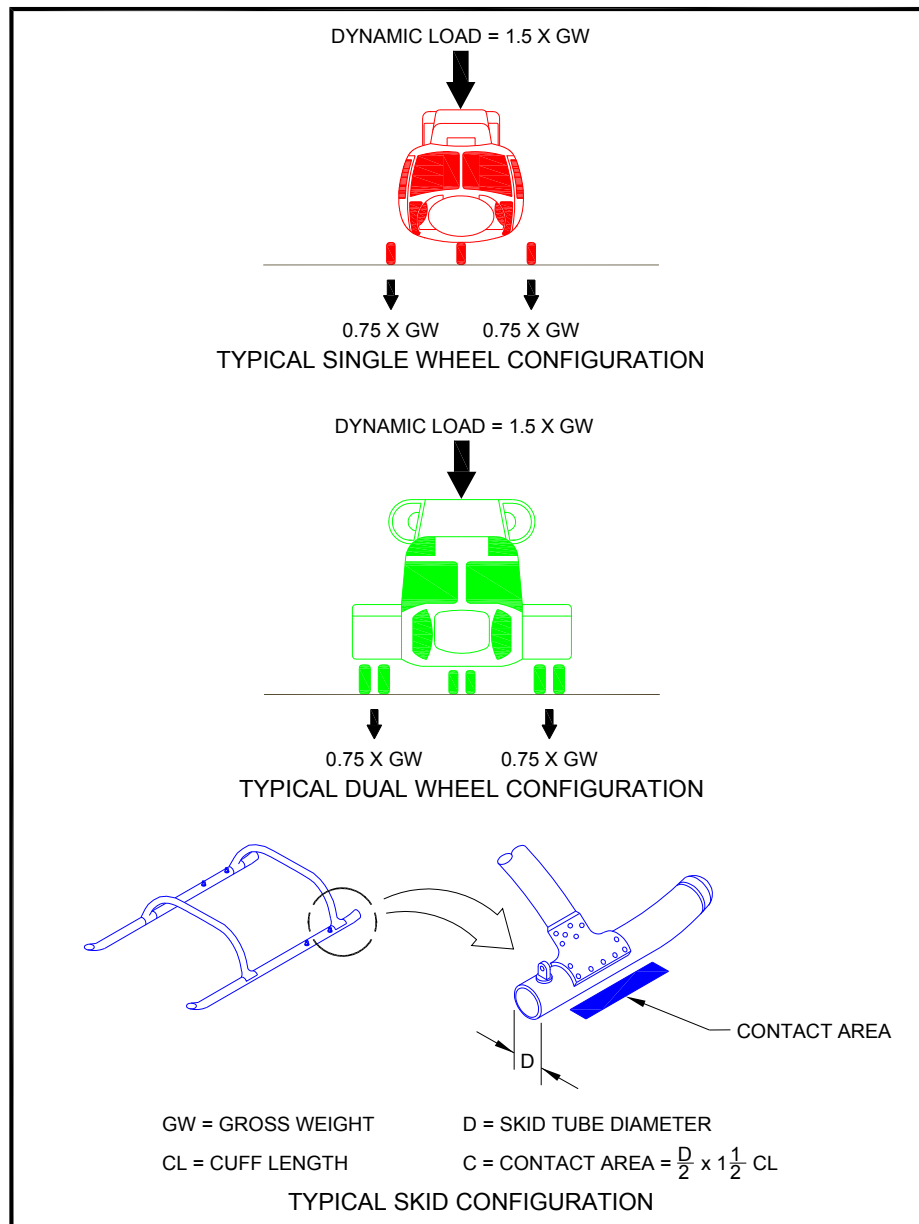
**(1) Turf.** A well-drained and well-established turf that presents a smooth, dense surface is usually the most cost-effective surface stabilization available. In some combinations of climates and weather conditions, turf surfaces are capable of supporting the weight of many of the smaller helicopters for low frequency use by private and corporate operators during much of the year. Turf surfaces also provide reasonable protection against wind, rotor wash, or water erosion. Climatic and soil conditions dictate the appropriate grass species to use at the site. Find guidance on turf establishment in AC 150/5370-10.

**(2) Aggregate turf.** Where heliports are located on soils that have poor load-carrying capabilities when wet, consider overcoming this deficiency by mixing selected granular materials into the upper 12 inches (30 cm) of the soil. Suitable granular materials for this purpose are crushed stone, pit-run

gravel, coarse sand, or oyster shells. Use a sufficient ratio of aggregate to soil to improve the stability of the soil yet retain the soil's ability to support grass. For additional guidance, see Item 217 of AC 150/5370-10.

**c. Formed masonry shapes.** Precast masonry shapes vary in size and shape—from a brick paver to an open block. Lay pavers on a prepared bed to present a solid surface. Embed precast blocks in the soil with grass growing in the natural openings. Architectural catalogs identify different masonry shapes that are commercially available for this purpose.

**d. Pierced metal panels.** Lay perforated metal panels that allow grass to grow through the openings on the ground to provide a hard surface for helicopter operations. Engineering catalogs identify commercially available panels.



**Figure 7–2. Helicopter Landing Gear Loading: Gradients and Pavement**

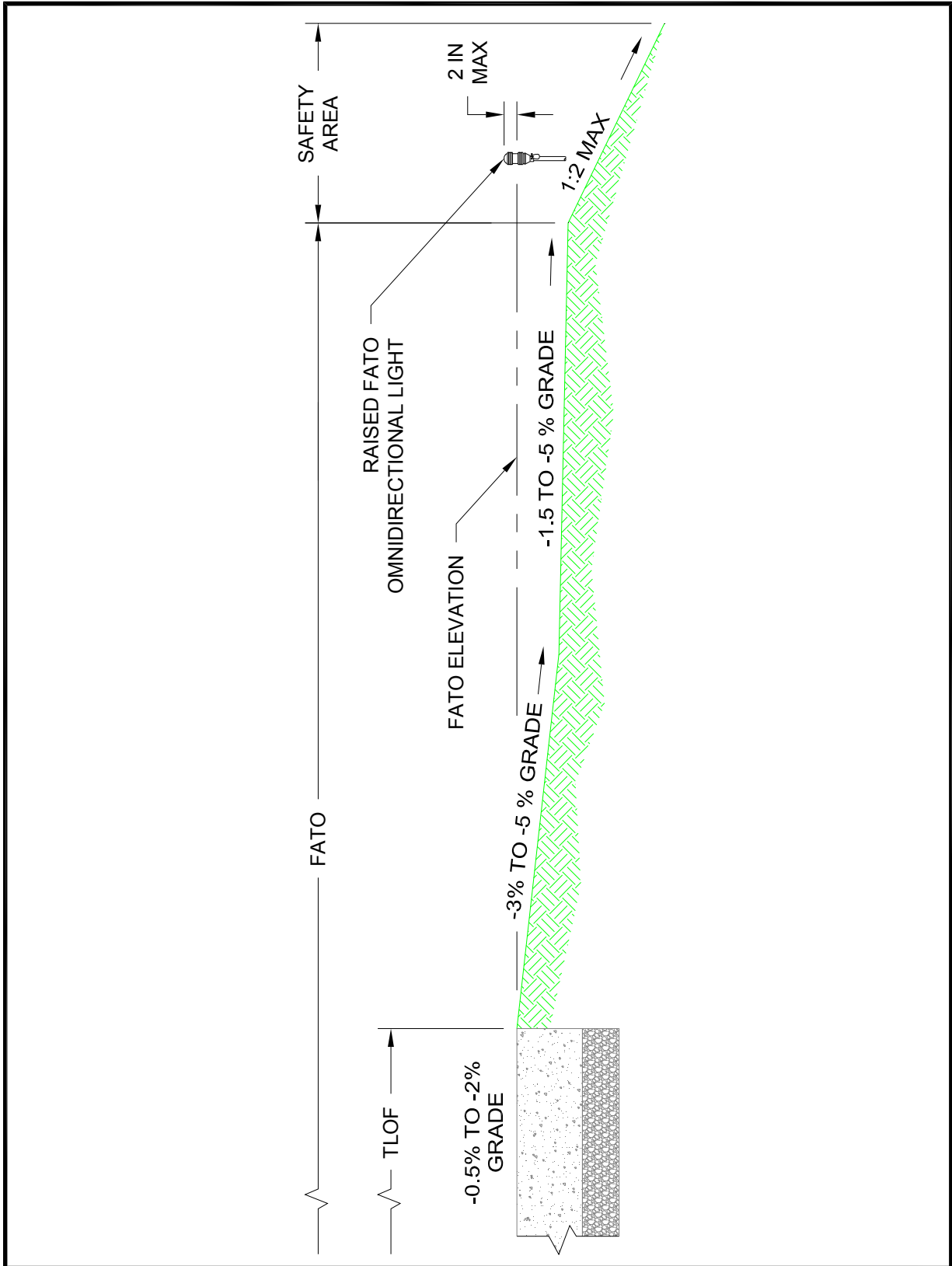


Figure 7-3. FATO Elevation

**This page intentionally left blank.**

## Appendix A. Emergency Helicopter Landing Facilities (EHLF)

**A-1. General.** Preplanning emergency landing areas will result in safer and more effective air-support operations. These facilities comprise rooftop emergency facilities and medical emergency sites. Use the following as a guide for developing emergency helicopter landing facilities (EHLF).

**A-2. Notification and coordination.** In addition to any requirements to provide notice under part 157, advise the local Terminal Approach Radar Control or the local Air Traffic Control facility manager in writing of the EHLF.

**A-3. Rooftop emergency facilities.** Review local building codes to determine if they require structures over a specified height to provide a clear area on the roof capable of accommodating a helicopter to facilitate fire fighting or emergency evacuation operations.

**a. Building code requirements.** State and local building code requirements apply to rooftop facilities. Develop the landing surface to the local fire department requirements based on the size and weight of the helicopter(s) expected to engage in fire or rescue operations (see Figure A-1). Find additional information in various National Fire Protection Association (NFPA) publications. For more reference material, see Appendix D.

**b. TLOF.**

**(1) Size.** Design the TLOF to be square, rectangular or circular in configuration and centered within the EHLF. Design the length and width or diameter to be at least 40 feet (12.2 m)

**(2) Weight capacity.** Design the TLOF to accept a 13,500-pound gross weight (GW) helicopter plus an impact load of 1.5 times GW.

**(3) Access.** Provide two pedestrian access points to the TLOF at least 90 degrees apart with a minimum of 60 feet (18 m) TLOF perimeter separation.

**(4) Drainage.** Design the surface so drainage flows away from pedestrian access points, with a maximum slope of 1.5 percent.

**c. FATO.** Design the FATO to be at the same level as the TLOF.

**(1) Size.** Design the FATO to extend a distance of at least 45 feet (13.7 m) in all directions from the center of the EHLF. For safe operation, provide clearance of one third of the rotor diameter (RD) of the largest helicopter expected but not less than 20 feet (6.1 m) between the helicopter's main and tail rotor blades and any object that could be struck by these blades.

**(2) Obstructions.** As an option, design the FATO to be an imaginary surface outside the TLOF and extending beyond the structure edge. Design the FATO to be unobstructed and without penetration of obstacles such as parapets, window washing equipment, penthouses, handrails, antennas, vents, etc.

**d. Safety area.** Provide a clear, unobstructed area, a minimum of 12 feet (3.7 m) wide, on all sides, outside and adjacent to the FATO.

**e. Safety net.** If the platform is elevated 4 feet (1.2 m) or more above its surroundings, Title 29 CFR Part 1910.23 Guarding Floor and Wall Openings and Holes, requires the provision of fall protection. The FAA recommends such protection for all platforms elevated 30 inches (76 cm) or more. However, do not use permanent railings or fences, since they would be safety hazards during helicopter operations. As an option, install a safety net, meeting state and local regulations but not less than 5 feet (1.5 m) wide. Design the safety net to have a load carrying capability of 25 lbs/sq ft (122 kg/sq m). Make sure the net does not project above the level of the TLOF. Fasten both the inside and outside edges of the safety net to a solid structure. Construct nets of materials that are resistant to environmental effects.

**f. Markings.**

(1) **TLOF perimeter.** Define the limits of the touchdown pad with a solid 12-inch (30 cm) wide red or orange line as illustrated in Figure A-1.

(2) **Touchdown/positioning circle (TDPC) marking.** Center a 12-inch wide red or orange circular marking, 30 feet (9.1 m) in diameter, within the TLOF. Use a contrasting color for the background within the circle.

(3) **Weight capacity.** Mark the TLOF with the maximum takeoff weight of the design helicopter, in units of thousands of pounds (for example, a number “9,” indicating 9,000 lbs GW), with each numeral ten feet in length, centered within the TLOF.

(4) **Markings for pedestrians.** Clearly mark rooftop access paths, EHLF access paths, and assembly zone(s) with surface paint and instructional signage.

**g. Access.**

(1) **Stairs.** Provide a minimum of two rooftop access stairs, with no less than 150 degrees separation, connecting to the top floor of the structure, with at least one providing access to the structure’s emergency staircase.

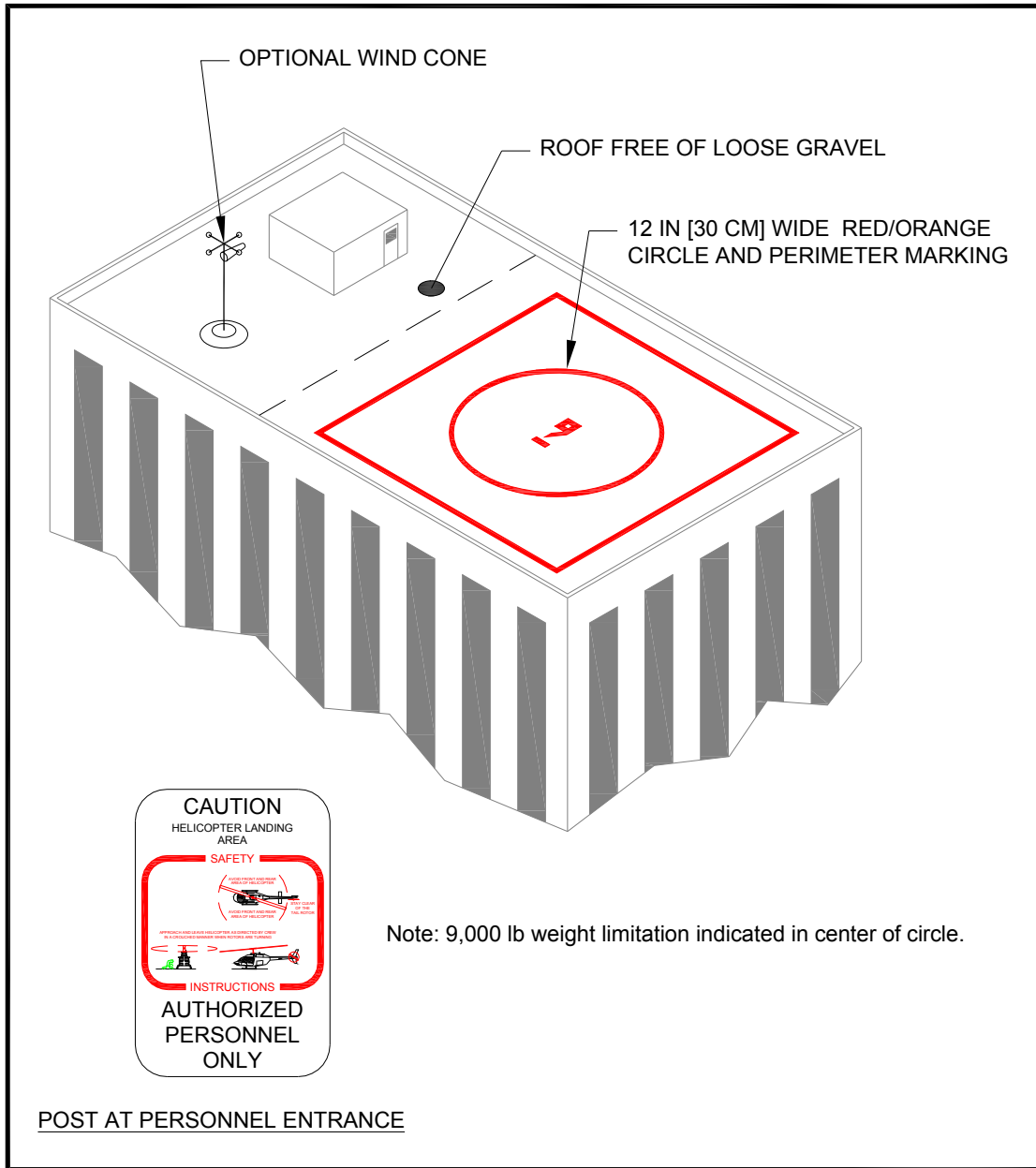
(2) **Doors.** Keep penthouse and stairwell rooftop access doors unlocked at all times to provide access to the EHLF. As an option, equip doors with “panic bar” hardware and/or alarm them.

**h. Wind cone.** Locate a wind cone assembly with an orange wind cone within the line of sight from the EHLF and outside the approach/departure path(s).

**i. Lighting.** Shield ambient rooftop lighting to avoid affecting the pilot’s vision.

**A-4. Medical emergency sites.** Medical emergency sites are clear and level areas near the scene of an accident or incident that the local emergency response team designates as the place where the helicopter air ambulance is directed to land in order to transport an injured person to a hospital. Provide such sites in various locations within a jurisdiction to support fast response to medical emergencies and accidents. Pre-designating medical emergency sites provides the opportunity to inspect potential sites in advance and to select sites that have adequate clear approach/departure airspace and adequate clear ground space.





**Figure A-1. Rooftop Emergency Landing Facility**

**This page intentionally left blank.**

### Appendix B. Helicopter Data

This appendix contains selected helicopter data needed by a heliport designer. These data represent the most critical weight, dimensional, or other data entry for that helicopter model, recognizing that specific versions of the model may weigh less, be smaller in some feature, carry fewer passengers, etc.

Various helicopter manufacturers have provided this information, but confirm data by contacting the manufacturer(s) of the specific helicopter(s) of interest.

#### Legend

A	Manufacturer name and helicopter model
B	Maximum takeoff weight in pounds.
D	Overall length in feet. (Rotors at their maximum extension.)
H	Overall height in feet. (Usually at tail rotor.)
RD	Rotor diameter in feet.
E	Number of blades.
F	Rotor plane clearance in feet.
TR	Distance from rotor hub to tip of tail rotor in feet.
I	Tail rotor diameter (in feet).
J	Number of tail rotor blades.
K	Tail rotor ground clearance in feet.
L	Type of undercarriage.
UCL	Undercarriage length in feet.
UCW	Undercarriage width in feet. (The distance between the outside edges of the tires or the skids.)
M	Number and type of engines
N	Number of crew and passengers.

Manufacturer/ Model	Max Takeoff Weight	Overall Length (ft)	Overall Height (ft)	Main Rotor				Tail Rotor			Undercarriage			Number of Engines/Type	Crew Number/Pax Number
				Diameter (ft)	Number of Blades	Ground Clearance (ft)	Tail Rtr Circle Radius (ft)	Diameter (ft)	Number of Blades	Ground Clearance (ft)	Type	Length (ft)	Width (ft)		
A	B	D	H	RD	E	F	TR	I	J	K	L	UCL	UCW	M	N
<b>AgustaWestland</b>															
A-109A	5,732	42.8	11.2	36.1	4	10	25	6.7	2	2.3	wheel	11.6	7.5	2-T	1-2&6-7
A-119 Koala	5,997	42.7	12.4	36.6	4	8.3	25.5	6.4	2	4.2	skid	13.4	5.5	1-T	1&6-7
AW-109E Power	6,283	42.8	11.5	36.1	4	8		6.4	2	3	wheel	11.5	7.1	2-T	1&7
AW-109S Grand	7,000	42.5	11.2	35.5	4	8		6.4	2	3.3	wheel	12.3	7.1	2-T	1-2&6-7
AW-119 Ke	6,283	42.4	11.8	35.5	4	9.3		6.4	2	3.8	skid	11.1	7	1-T	1&6-7
AW-139	14,991	54.7	16.4	42.6	5	12.9		8.9	4	7.5	wheel	14.2	10	2-T	1-2&15
AW-101	34,392	74.8	21.7	61	5	15.4	45	13.1		8.4	wheel	23	14.8	3-T	3&30
Westland WG30	12,800	52.2	15.5	43.7	4	12.5	31	8	4	7.5	wheel	17.9	10.1	2+T	2&19
<b>Bell Helicopter</b>															
47G	2,950	43.6	9.3	37.1	2	5	25	6.1	2	3.5	skid	9.9	7.5	1-P	1&2-3
205B, UH-1H, Huey II, 210	10,500	57.8	14.5	48	2	7.3	33.1	8.5	2	5.9	skid	12.1	8.8	1-T	1&14
206B-1,2,3	3,350	39.2	10.8	33.4	2	6	22.5	5.2	2	2.1	skid	8.1	6.7	1-T	1&4
206L-1,3,4	4,450	42.4	10.9	37	2	6.4	24	5.4	2	3.5	skid	9.9	7.7	1-T	1&6
212	11,200	57.3	14.9	48.2	2	7.5	22.2	8.5	2	6.1	skid	12.1	8.8	2-T	1&14
214ST	17,500	62.2	15.9	52	2	6.5	37	9.7	2	3.5	wheel/skid	12.1	8.6	2-T	2& 16-17
222B, UT	8,250	50.3	12.2	42	2	9.2	29.2	6.9	2	2.7	wheel/skid	12.2	7.8	2-T	1&9
230	8,400	50.3	11.7	42	2	9.2	29.2	6.9	2	2.7	wheel/skid	12.2	7.8	2-T	1&9
407	5,250	41.4	10.2	35	4	7.8	24.3	5.4	2	3.2	skid	9.9	8.1	1-T	1&6
412EP, SP, HP	11,900	56.2	14.9	46	4	11.5	34	8.6	2	4.8	skid	12.1	9.5	2-T	1&14
427VFR	6,550	42.6	10.5	37	4	6.4	24.1	5.7	2	3.3	skid	10	8.3	2-T	1&7
429	7,000	43	13.3	36	4	8.5		5.4	2	3.5	skid	9.9	8.8	2-T	1&7
430	9,300	50.3	13.3	42	4	8.2	29.2	6.9	2	3.7	wheel/skid	12.4	9.2	2-T	1&9

Manufacturer/ Model	Max Takeoff Weight	Overall Length (ft)	Overall Height (ft)	Main Rotor				Tail Rotor			Undercarriage			Number of Engines/ Type	Crew Number/ Pax Number
				Diameter (ft)	Number of Blades	Ground Clearance (ft)	Tail Rtr Circle Radius (ft)	Diameter (ft)	Number of Blades	Ground Clearance (ft)	Type	Length (ft)	Width (ft)		
A	B	D	H	RD	E	F	TR	I	J	K	L	UCL	UCW	M	N
<b>Boeing</b>															
107/CH-46E	24,300	84.3	16.7	51	3	15	59	51	3	17	wheel	24.9	14.5	2-T	3&25
234/CH-47F/G	54,000	99	19	60	3	11	69	60	3	19	wheel	22.5	10.5	2-T	3&44
<b>Brantly/ Hynes</b>															
B-2B	1,670	28.1	6.9	23.8	3	4.8	16	4.3	2	3	skid	7.5	6.8	1-P	1&1
305	2,900	32.9	8.1	28.7	3	8	19	4.3	2	3	wheel/ skid	6.2	6.8	1-P	1&4
<b>Enstrom</b>															
F-28F/ 280FX	2,600	29.3	9	32	3	6	20.6	4.7	2	3.1	skid	8	7.3	1-P	1&2
480B/ TH-28	3,000	30.1	9.7	32	3	6.5	21.2	5	2	3.6	skid	9.2	8	1-T	1&4
<b>Erickson</b>															
S-64E/F Air Crane	42,000 - 47,000	88.5	25.4	72	6	15.7	53	16	4	9.4	wheel	24.4	19.9	2-T	3&0
<b>Eurocopter</b>															
SA-315 Lama	5,070	42.3	10.2	36.2	3	10.1	20	6.3	3	3.2	skid	10.8	7.8	1-T	1&4
SA-316/319 Alouette	4,850	33.4	9.7	36.1	3	9.8	27.7	6.3	3	2.8	wheel	11.5	8.5	1-T	1&4
SA-330 Puma	16,315	59.6	16.9	49.5	4	14.4	35	10	5	6	wheel	13.3	9.8	2-T	2&20
SA/AS-332, Super Puma	20,172	61.3	16.3	53.1	4	14.6	36	10	5	7.1	wheel	17.3	9.8	2-T	2&24
SA-341/342 Gazelle	4,100	39.3	10.2	34.5	3	8.9	23	Fenstr on		2.4	skid	6.4	6.6	1-T	1&4
AS-350 A Star	4,960	42.5	11	35.1	3	10.6	25	6.1	2	2.3	skid	4.7	7.5	1-T	1&6
AS-355 Twin Star	5,732	42.5	9.9	35.9	3	10.3	25	6.1	2	2.3	skid	9.6	7.1	2-T	1&6
AS-360 Dauphin	6,600	43.3	11.5	37.7	4	10.7	25	Fenstr on		2.6	wheel	23.7	6.4	1-T	1&13
AS-365 Dauphin/H-65 Dolphin	9,480	45.1	13.3	39.2	4	11.4	24	Fenstr on		2.6	wheel	11.9	6.2	2-T	1&11
BO-105	5,732	38.9	11.5	32.3	4	9.8	23	6.2	2	6.1	skid	8.3	8.2	2-T	1&5
BK-117	7,385	42.7	12.6	36.1	4	11	25	6.4	2	6.3	skid	11.6	8.2	2-T	1&10

Manufacturer/ Model	Max Takeoff Weight	Overall Length (ft)	Overall Height (ft)	Main Rotor				Tail Rotor			Undercarriage			Number of Engines/ Type	Crew Number/ Pax Number
				Diameter (ft)	Number of Blades	Ground Clearance (ft)	Tail Rtr Circle Radius (ft)	Diameter (ft)	Number of Blades	Ground Clearance (ft)	Type	Length (ft)	Width (ft)		
A	B	D	H	RD	E	F	TR	I	J	K	L	UCL	UCW	M	N
EC-120	3,780	37.8	11.2	32.8	3	10.1	24.6	Fenstr on		2.1	skid	9.4	6.8	1-T	1&4
EC-130	5,291	41.5	11.8	35.1	3	11	23.7	Fenstr on		5.3	skid	10.5	7.9	1-T	1&7
EC-135	6,250	40	11.5	33.5	4	11	22.8	Fenstr on		5.6	skid	10.5	6.6	2-T	1&6
EC-145/ UH-72A	7,904	42.7	13	36.1	4	11.3	28	6.4	2	10.7	skid	9.5	7.9	2-T	1&8
EC-155	10,692	46.9	14.27	41.3	5	12	23	Fenstr on		3.1	wheel	12.8	6.2	2-T	2&12
EC-225	24,332	64	16.3	53.1	5	15.1	38	10.3	4	3.5	wheel	17.2	9.8	2-T	2&24
<b>Kaman</b>															
K-Max/ K1200	7,000	52	21	48.2	4	10.7	28	n	a	n/a	wheel	15.3	11.3	1-T	1&0
SH-2G Seasprite	14,200	52.5	15.1	44	4			8.1	4		wheel			2-T	3&8
<b>MD Helicopters</b>															
500E	3,000	30.8	8.4	26.4	5	8.2		4.6	2	2	skid	8.1	6.3	1-T	1&4
530F	3,100	32.1	8.1	27.4	5	8	19	4.8	2	1.3	skid	8.1	6.4	1-T	1&4
520N	3,350	32.1	9.7	27.4	5	9.2	17	NOTA R		n/a	skid	8.1	6.3	1-T	1&4
600N	4,100	36.9	9.8	27.5	6	9.2		NOTA R		n/a	skid	10.1	8.8	1-T	1&7
Explorer/ 902	6,500	38.8	12	33.8	5	12	23	NOTA R		n/a	skid	7.3	7.3	2-T	1-2& 6-7
<b>Robinson</b>															
R-22 Beta	1,370	28.8	8.9	25.2	2	8.8	16	3.5	2	4.1	skid	4.2	6.3	1-P	1&1
R-44 Raven	2,500	38.3	10.8	33	2	10.5	22	4.8	2	3.8	skid	4.2	7.2	1-P	1&3
R-66 Turbine	2,700	38.3	11.4	33	2	10.5		5	2	3.6	skid	4.2	7.5	1-T	1&4
<b>Fairchild-Hiller/ Rogerson-Hiller</b>															
360/UH-12/OH- 23	3,100	40.8	10.2	35.4	2	10.1	23	6	2	4	skid	8.3	7.5	1-P	1&3
FH/RH-1100	3,500	41.3	9.2	35.3	2	9.5	24	6	2	3	skid	7.9	7.2	1-T	1&4

Manufacturer/ Model	Max Takeoff Weight	Overall Length (ft)	Overall Height (ft)	Main Rotor				Tail Rotor			Undercarriage			Number of Engines/ Type	Crew Number/ Pax Number
				Diameter (ft)	Number of Blades	Ground Clearance (ft)	Tail Rtr Circle Radius (ft)	Diameter (ft)	Number of Blades	Ground Clearance (ft)	Type	Length (ft)	Width (ft)		
A	B	D	H	RD	E	F	TR	I	J	K	L	UCL	UCW	M	N
Sikorsky/ Schweizer															
HU-269A/A-1/B, TH55A	1,850	29	9	26	3	8.8	15	3.8	2	2.5	skid	8.3	6.5	1-P	1&1
300C	2,050	30.8	8.7	26.8	3	8.7	15.3	4.3	2	2.8	skid	8.3	6.5	1-P	1&2
300CB/CBi	1,750	30.8	8.7	26.8	3	8.7	15.3	4.3	2	2.8	skid	8.3	6.5	1-P	1&1
330/330SP/ 333	2,550	31.2	11	27.5	3	9.2	15.3	4.3	2	3.2	skid	8.3	6.5	1-T	1&2-3
S-434	2,900	31.2	11	27.5	4	9.2	15.3	4.3	2	3.2	skid	8.3	6.5	1-T	1&2-3
S-55/H19	7,900	62.6	13.1	53	3			8.2	2		wheel			1-T	2&12
S-58/H34	14,600	65.8	15.9	56	4	11.4	38	9.5	4	6.4	wheel	28.3	14	2-T	2&16
S-61/H-3	22,000	72.8	19	62	5	12.3	40	10.3	5	8.6	wheel	23.5	14	2-T	3&28
S-76A/B/C/D	11,700	52.5	14.6	44	4	8.2	30.5	8	4	6.5	wheel	16.4	8	2-T	2&12
S-92	26,500	68.5	17.9	56.3	4	9.8	39.9	11	4	6.9	wheel	20.3	10.4	2-T	2&19
S-70i/UH-60L Blackhawk	22,000	64.8	16.8	53.8	4	7.7	38	11	4	6.6	wheel	29	9.7	2-T	3&12
CH-53K	74,000	99.5	27.8	79	7	17	59.6	20	4	9.5	wheel	27.3	13	3-T	3&55

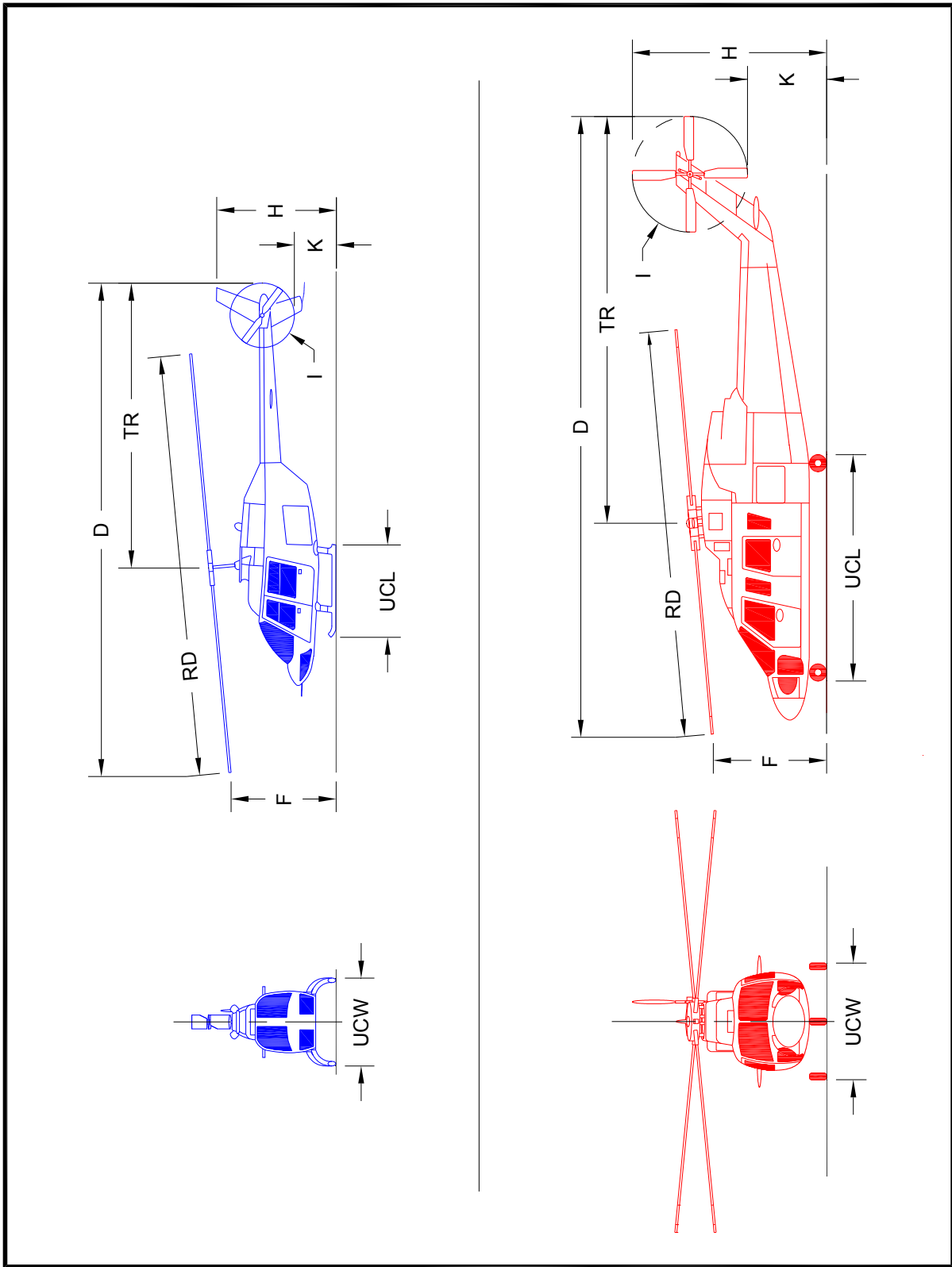
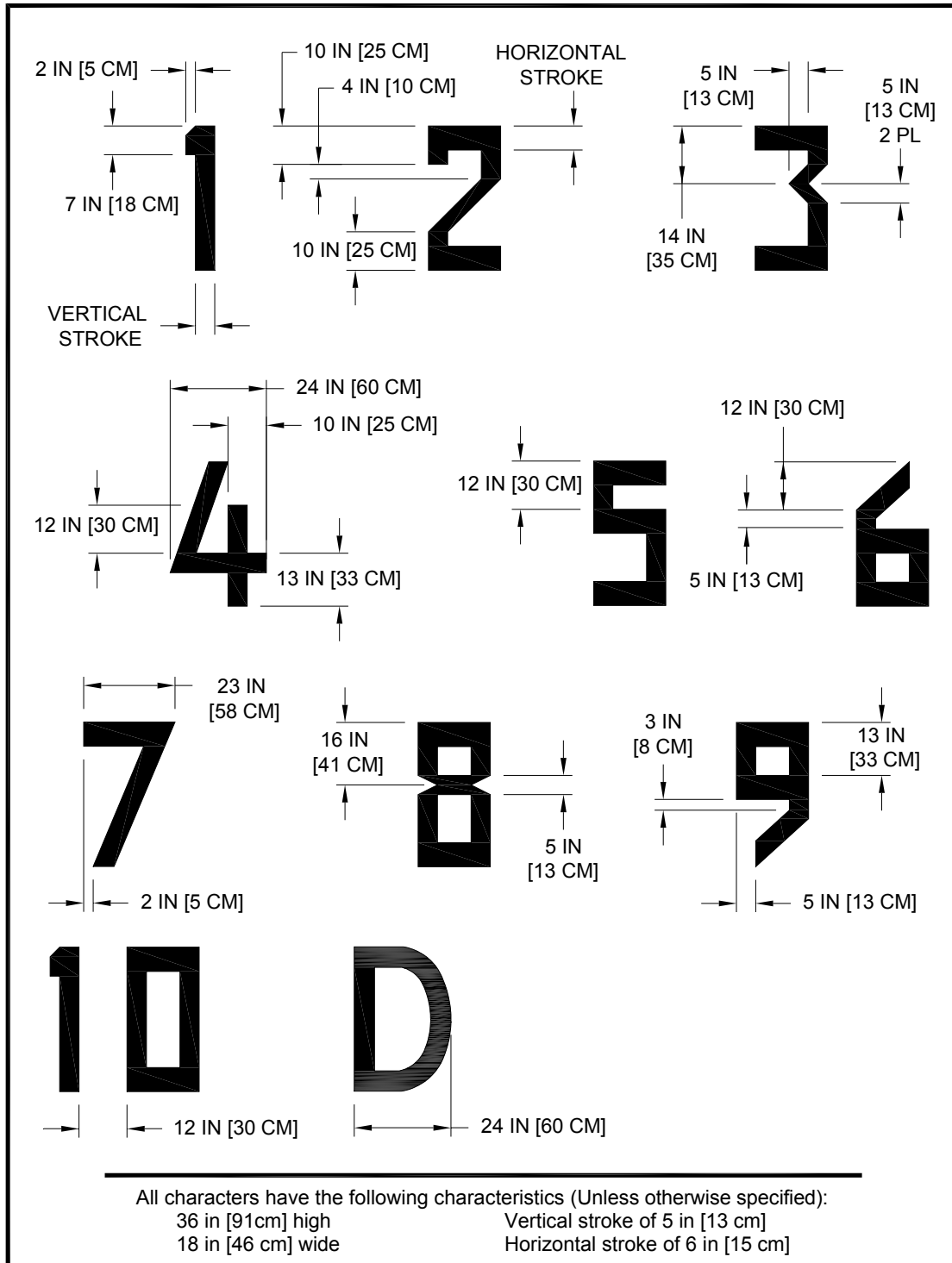


Figure B-1. Helicopter Dimensions

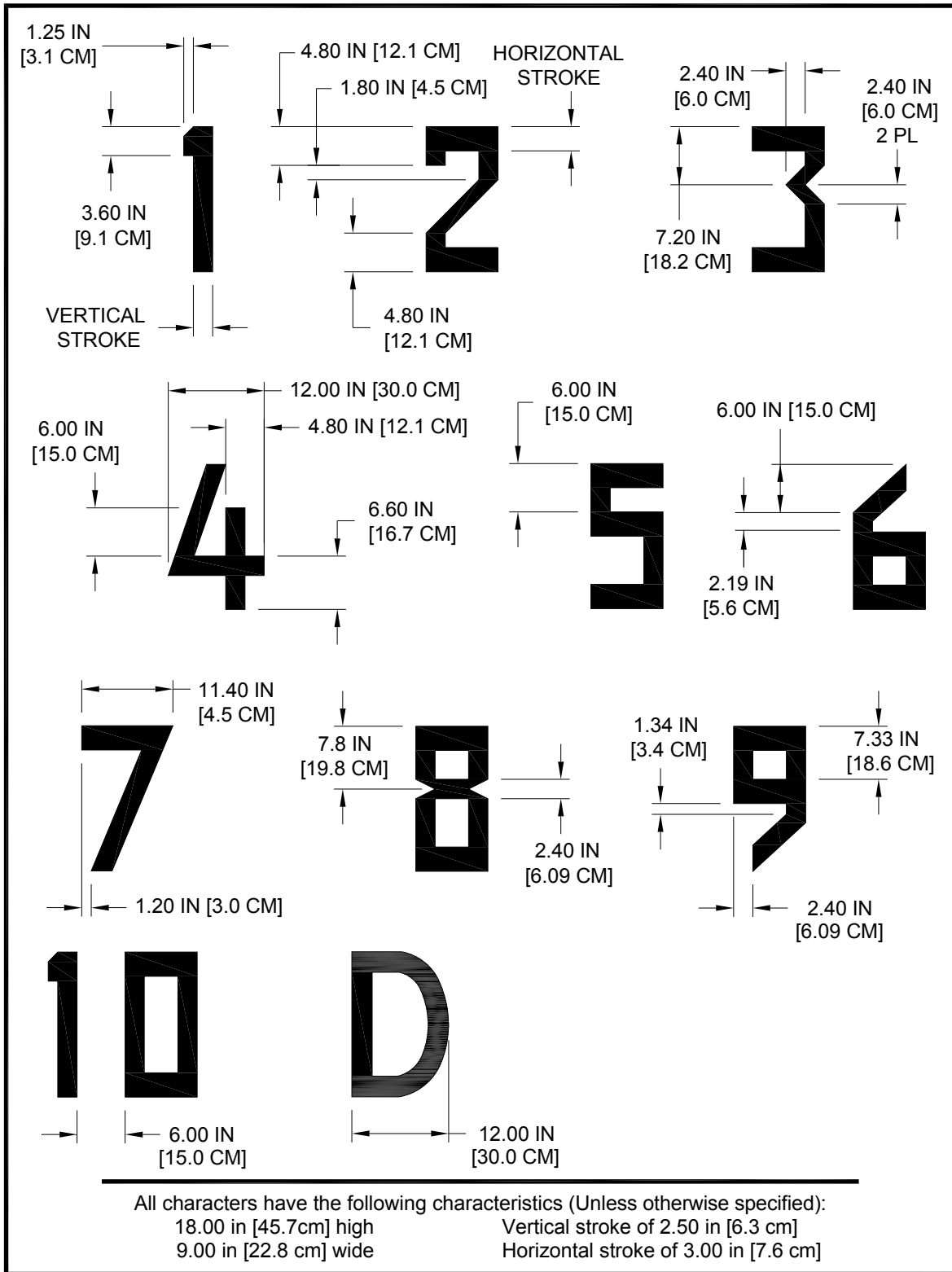


**Appendix C. Dimensions for Marking Size and Weight Limitations**

The form and proportion of numbers for marking TLOF and parking area size and weight limitations are shown below.



**Figure C-1. Form and Proportions of 36 Inch (91 cm) Numbers for Marking Size and Weight Limitations**



**Figure C-2. Form and Proportions of 18 Inch (45.7 cm) Numbers for Marking Size and Weight Limitation**

## Appendix D. Associated Publications and Resources

The following is a listing of related documents.

Current Advisory Circulars are available from the FAA web site

[http://www.faa.gov/regulations\\_policies/advisory\\_circulars/](http://www.faa.gov/regulations_policies/advisory_circulars/).

Current Electronic Code of Federal Regulations (e-CFRs) are available from the

Government Printing Office web site <http://www.gpoaccess.gov/ecfr/>.

Airport Advisory Circulars are available at the Airports web site

[http://faa.gov/airports/resources/advisory\\_circulars/](http://faa.gov/airports/resources/advisory_circulars/).

Technical reports are available at the National Technical Information Service (NTIS) web

site <http://www.ntis.gov/>.

To find state and regional aviation offices, see

[http://www.faa.gov/airports/resources/state\\_aviation/](http://www.faa.gov/airports/resources/state_aviation/).

For information about grant assurances, see

[http://www.faa.gov/airports/aip/grant\\_assurances/](http://www.faa.gov/airports/aip/grant_assurances/).

1. 14 CFR Part 27, Airworthiness Standards: Normal Category Rotorcraft.
2. 14 CFR Part 29, Airworthiness Standards: Transport Category Rotorcraft.
3. 14 CFR Part 77, Safe, Efficient Use, and Preservation of the Navigable Airspace.
4. 14 CFR Part 91, General Operating and Flight Rules.
5. 14 CFR Part 121, Air Carrier Certification.
6. 14 CFR Part 135, Operating Requirements: Commuter and on demand operations and rules governing persons on board such aircraft.
7. 14 CFR Part 139, Certification of Airports.
8. 14 CFR Part 151, Federal Aid to Airports.
9. 14 CFR Part 152, Airport Aid Program.
10. 14 CFR Part 157, Notice of Construction, Alteration, Activation, and Deactivation of Airports.
11. AC 70/7460-1, Obstruction Marking and Lighting.
12. AC 150/5190-4, A Model Zoning Ordinance to Limit Height of Objects Around Airports.
13. AC 150/5200-30, Airport Winter Safety and Operations.
14. AC 150/5220-16, Automated Weather Observing Systems (AWOS) for Non-Federal Applications.
15. AC 150/5230-4, Aircraft Fuel Storage, Handling, and Dispensing on Airports.
16. AC 150/5300-18, General Guidance and Specifications for Submission of Aeronautical Surveys to NGS: Field Data Collection and Geographic Information System (GIS) Standards.
17. AC 150/5320-6, Airport Pavement Design and Evaluation.
18. AC 150/5340-30, Design and Installation Details for Airport Visual Aids.
19. AC 150/5345-12, Specification for Airport and Heliport Beacons.
20. AC 150/5345-27, Specification for Wind Cone Assemblies.
21. AC 150/5345-28, Precision Approach Path Indicator Systems (PAPI).

22. AC 150/5345-39, FAA Specification L-853, Runway and Taxiway Retroreflective Markers.
23. AC 150/5345-46, Specification for Runway and Taxiway Light Fixtures.
24. AC 150/5345-52, Generic Visual Glideslope Indicators (GVGI).
25. AC 150/5360-9, Planning and Design of Airport Terminal Facilities at Non-Hub Locations.
26. AC 150/5360-14, Access to Airports by Individuals with Disabilities.
27. AC 150/5370-10, Standards for Specifying Construction of Airports.
28. FAA 8260-series orders, various on flight procedures, airspace, others.
  - a. FAA Order 8260.3B, U. S. Standard for Terminal Instrument Procedures (TERPS).
  - b. FAA Order 8260.54A, U.S. Standard for Area Navigation (RNAV).
  - c. FAA Order 8260.72, Performance Based Navigation (PBN) Fly-By (FB)/Radius-to-Fix (RF) Turn Maximum Design Bank Angle Limits
29. FAA Grant Assurance No. 34, Policies, Standards, and Specifications.
30. FAA Order 1050.1 Policies and Procedures for Considering Environmental Impacts.
31. FAA Order 5050.4, National Environmental Policy Act (NEPA) Implementing Instructions for Airport Projects.
32. FAA Order JO 7400.2, Procedures for Handling Airspace Matters.
33. FAA Passenger Facility Charge (PFC) Assurance No. 9, Standards and Specifications
34. FAA Technical Report FAA/RD-84/25, Evaluating Wind Flow Around Buildings on Heliport Placement, National Technical Information Service (NTIS) accession number AD-A153512.
35. FAA Technical Report FAA/RD-92/15, Potential Hazards of Magnetic Resonance Imagers to Emergency Medical Service Helicopter Services, National Technical Information Service (NTIS) accession number AD-A278877.
36. ICAO Annex 14, Vol. II – Heliports.
37. National Fire Protection Association (NFPA) 403, Standard for Aircraft Rescue and Fire-Fighting Services.
38. National Fire Protection Association (NFPA) 407, Standard for Aircraft Fuel Servicing.
39. National Fire Protection Association (NFPA) 418, Standard for Heliports.
40. Roadmap for Performance Based Navigation (PBN).